Perimeter Radiation Monitors

P. E. Feblau

19.1 INTRODUCTION

Perimeter radiation monitors are located at the periphery of nuclear-material and radioactive-contamination control areas to detect accidental or covert removal of radioactive materials. Two types of perimeter monitors are in use today: contamination monitors and nuclear-material monitors. Contamination monitors detect contamination on the surface of a person or an object where the radiation comes from an extended area viewed without intervening absorbers. Nuclear-material monitors must be able to detect small, possibly shielded quantities of nuclear material that may be hidden, for example, in a briefcase. In this case the small source size and the presence of absorbers reduces the radiation intensity. This chapter discusses the two applications of perimeter monitors but gives primary emphasis to nuclear-material monitors.

The need to detect contamination predated security concerns so that when the need for monitors to detect nuclear material arose, hand-held contamination monitors were available. However, because security personnel had to interpret an analog meter display to use this type of instrument, their attention was distracted from the security search. Automatic portal monitors (Ref. 1) and hand-held monitors (Ref. 2) were developed to eliminate the distraction. These monitors provide audible alarm signals that allow the operator to devote full attention to the security search. More recently, the responsibility of employers to furnish top-grade contamination monitoring equipment to employees has fostered development of automatic, high-sensitivity contamination monitors (Ref. 3). These, as well as modern nuclear-material monitors, are designed for high sensitivity, dependability, and easy maintenance.

Diversion monitors meet Department of Energy (Ref. 4) and Nuclear Regulatory Commission (Ref. 5) requirements to search each person, package, or vehicle leaving a nuclear-material access area. Contamination monitors meet radiation safety standards for monitoring persons leaving a radioactive-contamination area. In both cases, visual or manual searches may be ineffective, but radiation monitors sense radiation emitted by the materials and can conduct unobtrusive, sensitive, and efficient searches. The monitors provide timely notice of contamination or diversion before the controlled material can leave an access area.

Examples of diversion monitors are the automatic portal monitor (shown in Figure 19.1 with its detectors positioned beside a passing pedestrian) and the hand-held monitor (shown being manually scanned over a pedestrian in Figure 19.2). The versatile hand-held monitors have many applications, even to contamination monitoring, but their effectiveness depends on the operator making a thorough scan. In contrast, portal monitors are fully automatic.



Fig. 19.1 Automatic nuclear-material portal monitor with large plastic scintillators to monitor pedestrians.

New monitor designs locate detectors inside an enclosure (see Figure 19.3) where an individual being monitored must stand near radiation detectors for an extended period. The longer monitoring period and the proximity of the occupant and the detectors improve detection sensitivity; these principles have been applied to both pedestrian and motor-vehicle monitoring.

19.2 BACKGROUND RADIATION EFFECTS

Radiation monitors are influenced by background radiation and the variation of its intensity with time. The intensity of the background radiation influences the effectiveness of monitoring. Alarm thresholds must be set well above background intensity to avoid alarms from counting statistics (one cause of nuisance alarms). The required threshold setting becomes proportionately higher as the background intensity increases, causing the monitoring sensitivity to decrease. In an occupied monitor, rapid variations in background intensity, which can be caused by natural background radiation processes, movement of radioactive materials, or radiation-producing machinery, may be mistaken for nuclear-material signals and cause another type of nuisance alarm. An example of a natural background radiation process leading to rapid intensity variation is



Fig. 19.2 Monitoring with hand-held instruments is highly effective when the operator is well trained and motivated.

the decay of ^{226}Ra in soil. Its gaseous daughter, ^{222}Rn , can escape the soil to decay in the atmosphere. These daughter products, which are themselves radioactive, may attach to dust particles that form condensation points for raindrops. When the raindrops fall to the ground they temporarily increase background intensity (see Figure 19.4).

19.3 CHARACTERISTICS OF DIVERSION AND CONTAMINATION SIGNALS

19.3.1 Radiation Sources

As described in Chapter 1, nuclear materials can be detected by their spontaneous radiations. These radiations—alpha, beta, gamma ray, x ray, and neutron—each have a different ability to penetrate materials. Alpha radiation is not very penetrating and is easily stopped by several centimeters of air. Except when contamination detectors almost touch the emitter, alpha radiation contributes little signal to a radiation monitor.

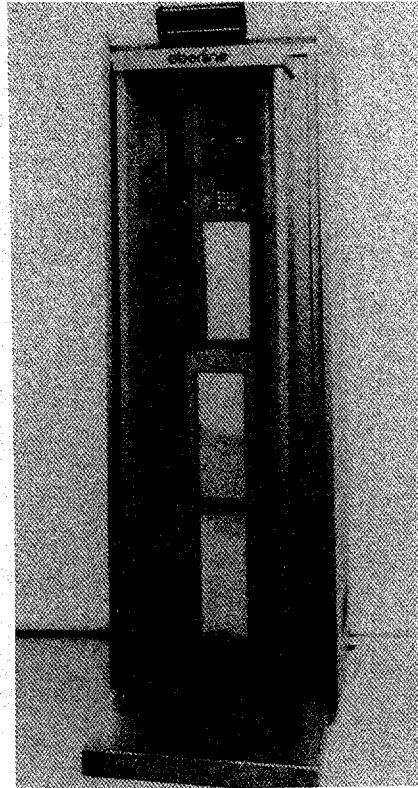

Fig. 19.3 This sensitive contamination monitor measures each side of the occupant's body separately. (Photo courtesy of Eberline Instrument Corp., Santa Fe, New Mexico.)

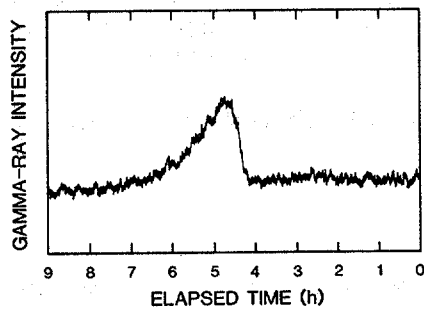

Fig. 19.4 A background intensity record showing a road bed monitor count-rate increase during brief intense precipitation.

More penetrating forms of radiation that easily pass through air can be detected at a distance. However, the shielding provided by detector cabinets and nuclear-material packaging may exclude all but gamma-ray and neutron signals. One important aspect separates the signals available to contamination and diversion monitors: contamination usually lies on a surface where its radiation is readily detected, whereas diversion monitors must sense penetrating radiation from material that is encapsulated. Hence, contamination monitors often detect many forms of radiation but diversion monitors primarily detect gamma rays and neutrons. The nuclear-material diversion monitors discussed in the remainder of this chapter mainly detect gamma rays but do have some neutron sensitivity. Figure 19.5 illustrates absorption of three types of radiation in different materials.

Internal absorption of source radiation also may significantly alter detection signals. For example, nuclear materials shield their own gamma radiation; the extent of self-absorption depends on the physical form of the material. Figure 19.6 illustrates self-absorption in different shapes and sizes of highly enriched uranium. Thin uranium materials such as powders and foils emit most of their radiation, whereas more compact shapes such as spheres and cylinders absorb most of it. The cylinders in Figure 19.6 emit in proportion to their surface area, which increases as the $2/3$ power of the mass, giving rise to the straight line in the plot.

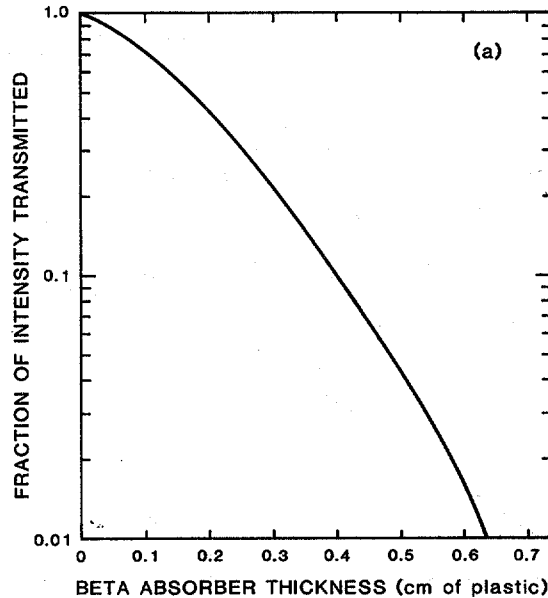

Fig. 19.5 (a) Continuous spectrum beta rays (end point 1.9 MeV) are easily absorbed in a few centimeters of plastic.

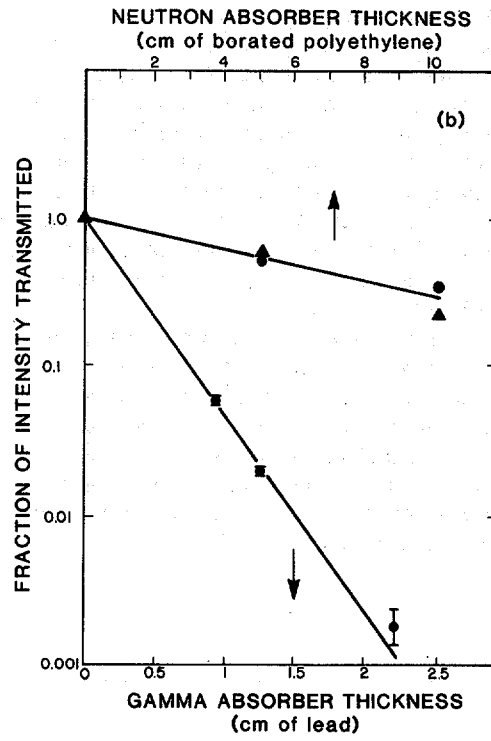

Fig. 19.5 (b) Plutonium gamma rays are absorbed in modest thicknesses of lead, but its neutrons are less affected by large thicknesses of borated polyethylene.

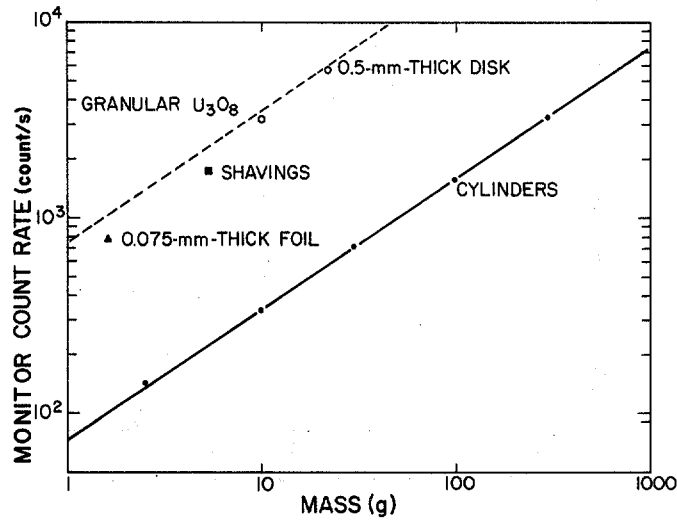

Fig. 19.6 The form of highly enriched uranium influences the self-absorption of gamma rays. The emitted intensity varies with the surface area rather than the mass.

19.3.2 Time-Varying Signals

Diversion or contamination signals are usually present in a monitor for only a short time interval. Unless the occupant is stationary, signals from nuclear material will vary during the monitoring period as the occupant moves toward and away from the detectors. Figure 19.7 illustrates the net signal in a monitor as a pedestrian passes through carrying nuclear material. The time integral of the variable signal is about 60% of that for a stationary occupant. Good monitor design ensures that the monitoring period matches the intense part of the signal as closely as possible. Techniques for obtaining this optimum situation are discussed in Section 19.4.

A complementary effect that diminishes signals in a monitor is the reduction in background intensity caused by an occupant. Ambient background radiation from the monitor's surroundings can be partly absorbed by the person or vehicle occupying the monitor. The reduction in intensity may be only 1.5% for pedestrians but is much greater for motor vehicles. Figure 19.8 illustrates the reduction caused by the presence of a truck in a vehicle monitor. The reduction ranges from 10% to 25% for different-size vehicles. Because the monitor's alarm threshold is constant, a much larger signal is required to alarm an occupied monitor than one that is unoccupied.

19.4 SIGNAL ANALYSIS

19.4.1 Detecting Radiation Signals

Radiation monitors use signal analysis to decide whether a measurement indicates a background signal alone or a background signal plus an additional radiation signal. Unfortunately, statistical variations in background and monitoring measurements preclude a simple comparison. Although the expected background may be determined

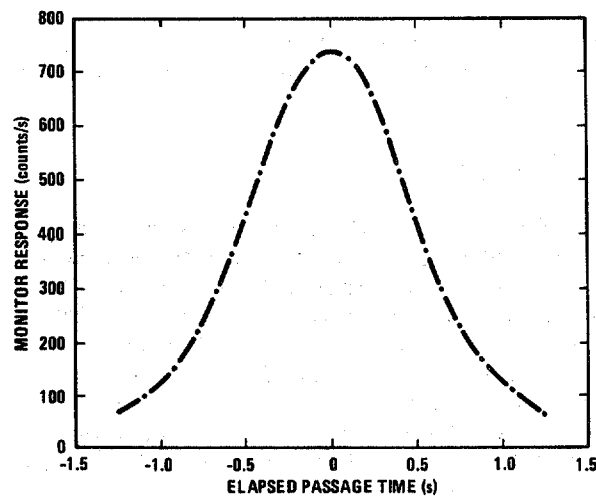

Fig. 19.7 A bell-shaped signal intensity profile results from a pedestrian carrying nuclear material through a portal monitor.

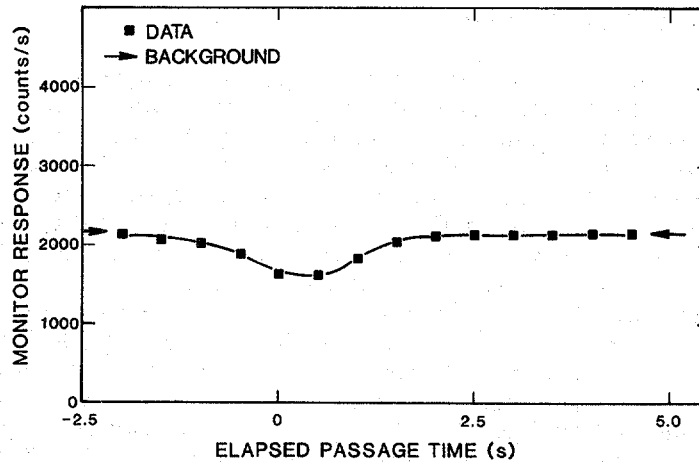

Fig. 19.8 An inverted bell-shaped reduction in the monitor's response to background radiation results from the passage of a vehicle.

from a long, precise measurement, each monitoring measurement is necessarily short and imprecise. If background measurements have an expected count B , individual measurements will range many standard deviations higher and lower than B ; one standard deviation in this instance is the square root of the count B . Comparisons of monitoring measurements must allow statistical variations of several times the square root of B to exclude nuisance alarms. Each monitoring measurement is usually compared to an alarm threshold equivalent to that given by Equation 19-1. An alarm is sounded when the measurement equals or exceeds the alarm threshold M .

$$M = B + N \sqrt{B} \quad (19-1)$$

where N = alarm increment (number of standard deviations, usually 3 or 4). Alarms are real when they result from real signals and are nuisance alarms when they result from statistical variation or background changes.

19.4.2 Analog Detection Methods

A simple and dependable method for making monitoring decisions is provided by an analog method (Ref. 6) that compares monitoring intensities to background intensities with two circuits having different time constants (Figure 19.9). The slow circuit remembers background intensity over a period of perhaps 20 s, whereas the monitoring circuit has a fast, 0.4-s time constant. The comparator is calibrated by adjusting the input—an analog signal from a ratemeter—until a chosen sensitivity and nuisance-alarm rate are achieved. Once properly adjusted, the circuit operates continuously and is prepared to monitor signals whenever they appear. A drawback to analog circuits is the manual adjustment procedure; precise adjustment can take a great deal of time. Digital logic methods, on the other hand, are free of most adjustments.

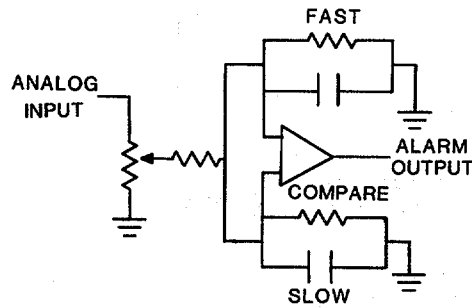

Fig. 19.9 This analog circuit compares monitoring intensity to background intensity.

19.4.3 Digital Detection Methods

Alarm decisions can be made by digital circuits and microprocessors. Equation 19-1 can be implemented, for example, by comparing the result of a 0.4-s monitoring measurement contained in a digital register to a stored alarm threshold derived from an earlier background measurement. The stored alarm threshold might have been derived from an earlier 20-s background measurement, divided by 50 to obtain B , plus an added multiple of the square root of B . In this case, the comparison is a numerical one with no calibration required. This single-interval method does have a shortcoming: it is not continuous so the measurement interval may not match the most intense part of the signal (see Figure 19.7). However, digital logic methods are easily changed to overcome such shortcomings. The improvements described below include the moving-average method, the stepwise method, and the sequential hypothesis test.

A digital method that performs well in free-passage monitors uses a moving average of monitoring measurements. Short measurement periods are used (for example, 0.2 s) and the counts from four or more measurement periods are summed and compared to the alarm threshold. After the first group of four or more periods, each new measurement is added and the oldest measurement is subtracted from the sum. Every new sum is compared to the alarm threshold; measurements then continue unless an alarm occurs or the monitor is no longer occupied. Because monitoring is continuous and many decisions are made, the alarm threshold must be higher than for the single-interval test (described in the preceding paragraph) to achieve the same statistical-alarm probability. However, the moving-average method obtains greater sensitivity because it measures the most intense part of the signal.

A simple stepwise method (Ref. 7) shortens measurement periods in monitors that require the occupant to wait until a measurement is completed. An extended monitoring period achieves higher detection sensitivity without an increased statistical-alarm frequency. The waiting time can be shortened by subdividing the measurement period into steps where intermediate decisions are made. The full period is needed only when all intermediate decisions call for an alarm. Otherwise, monitoring is completed after the first step that does not call for an alarm. Each intermediate alarm threshold has the same source detection sensitivity as the full measurement period but has a higher statistical-alarm probability. Figure 19.10 illustrates the technique; all but about 2.3% of the vehicles not carrying radioactive material will depart after the first interval, which has a

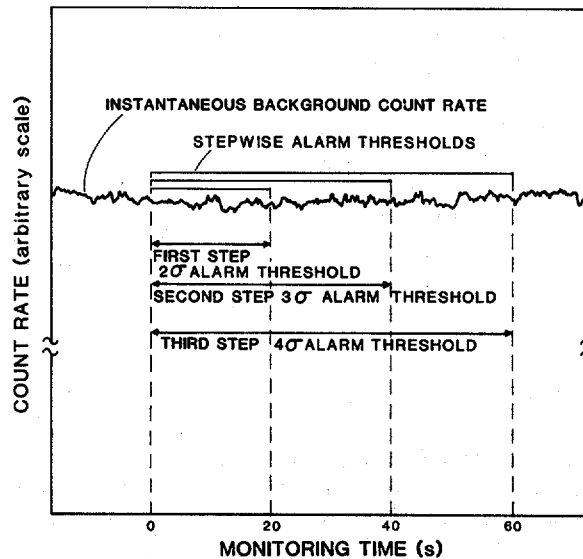

Fig. 19.10 *The stepwise method makes intermediate decisions at lower alarm thresholds that maintain sensitivity at the expense of more frequent false alarms. The penalty for the occasional false alarm is to wait for one more step. For the thresholds shown in this figure, the average waiting time is reduced by two thirds.*

two-standard-deviation alarm threshold. Those that are detained are measured for one or more additional periods and the results are added to the first result and reanalyzed at successively higher alarm thresholds. If alarms persist, the final measurement and final decision are made as if no intermediate decisions had been made.

Work performed by Wald (Ref. 8) during the 1940s developed a sequential hypothesis test to reduce quality control measurement time in manufacturing. The sequential hypothesis test also shortens the measurement time in radiation monitoring (Ref. 9). This method uses a sequence of short measurements, each followed by a hypothesis test. The outcome of each test is one of three possible decisions: the accumulated measurements represent background, the measurements require an alarm, or the measurements must continue before a decision can be made. If one of the first two possible decisions is not reached quickly enough, a final decision is made by some other method.

In discussing applications of this method, Ref. 9 reports an average measurement period that is 22% as long as that required by the single-interval method, with no increase in statistical-alarm frequency. Monitoring is also rapid when a nuclear-material signal is present unless the radiation intensity is very near the alarm threshold. In that case the sequential hypothesis test requires as much time as the single-interval method.

19.4.4 Long-Term Monitoring

Long-term monitoring is a novel technique that achieves high sensitivity through repeated measurements applied in conjunction with, but independent of, other standard techniques (Ref. 10). The method can detect repeated instances of contamination or diversion of nuclear material in quantities too small to detect in normal monitoring. One application of the method sums the net monitoring results for pedestrians entering an area and compares this sum to the sum for pedestrians leaving the area. Any difference between the two may signify contamination or diversion of nuclear material.

The long-term monitoring method calculates the net signal during occupancy by subtracting from each measurement an average background determined before and after the measurement. Although individual measurements are imprecise, the average net signal for hundreds of passages is quite precise. In fact, this method provides the most precise measurement of the average background radiation attenuation by monitor occupants.

In addition to being able to average monitoring results for large populations, the method can require identification of each occupant so that data for each individual can be recorded. Then analysis of long-term averages of the incoming and outgoing measurements for an individual can identify cases of repeated contamination or diversion of small quantities of nuclear material. For cases where each outgoing passage involves contamination or diversion and each incoming passage does not, the long-term monitoring method is ten times more sensitive than other methods.

19.5 RADIATION DETECTORS

Perimeter monitors use a different type of radiation detector depending on whether they are designed to detect contamination or diverted nuclear material. Gas proportional counters are most appropriate for detecting the radiation from contamination, and scintillators are most appropriate for detecting the penetrating radiation from diverted material. The general properties of gas proportional counters and inorganic scintillators are discussed in Chapter 3; organic scintillators, which are widely applied to perimeter diversion monitoring, are discussed in this section along with gas-flow proportional counters for perimeter contamination monitoring. These inexpensive, large-area detectors are well adapted to the requirements of perimeter monitoring.

19.5.1 Plastic Scintillators

Plastic scintillation detectors are solid organic scintillators that contain fluorescent compounds dissolved in a solidified polymer solute (Ref. 11). These materials have low density and low atomic number so they lack strong photoelectric absorption. They detect gamma rays by detecting Compton recoil electrons, and they detect neutrons by detecting recoil protons. These detectors do not display full-energy peaks; they display a continuous spectrum from the Compton edge down to zero energy. Although organic scintillators are poor energy spectrometers and have low intrinsic detection efficiency,

they make excellent large-area, low-cost radiation counters. Their low cost results from the use of inexpensive materials and simple packaging; NaI(Tl) crystals, on the other hand, are expensive to grow and to protect from moisture and thermal shock.

The large size of plastic scintillators gives them good total detection efficiency even though their intrinsic efficiency is low. Total efficiency is the product of a detector's intrinsic efficiency and the fraction of emitted photons that strike the detector. The latter factor depends on the size of the detector. The large detector size also provides more uniform monitoring than would an array of small detectors.

Plastic scintillation detectors do have some shortcomings. They produce only about 10% as much light as NaI(Tl) detectors, and their large size makes uniform light collection difficult. Uniform light collection is important to minimize the spread in pulse heights resulting from detection of radiation in different parts of a detector. Reference 12 describes methods for obtaining total internal reflection of scintillation light and for making a large detector's response homogeneous. Low light production is compensated for by using bialkali cathode photomultipliers that provide good signal amplification with low photocathode dark current and noise.

Low photomultiplier noise is important in organic scintillators because the Compton pulse-height spectrum extends down to zero pulse height. Noise sets a practical limit to the pulse amplitude that can be detected; this bias level limits the intrinsic detection efficiency. The bias level influences detection efficiency over a broad range of incident gamma-ray energy as illustrated in Figure 19.11. Bialkali photocathodes can operate near the 0.045-V bias level at room temperature.

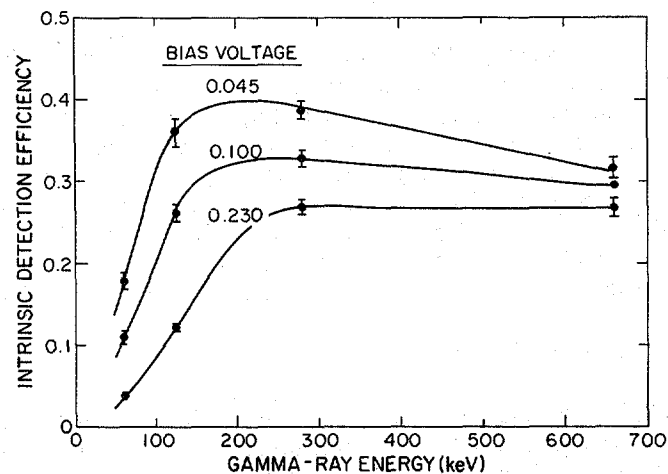

Fig. 19.11 Low bias voltage is essential to good intrinsic detection efficiency in organic scintillators. The data illustrated here were taken with a detector that yielded 2-V pulse height for incident 662-keV gamma rays.

19.5.2 Gas-Flow Detectors

An inexpensive form of gas proportional counter is the very large area gas-flow proportional counter. Very thin detector windows ($100 \mu\text{g}/\text{cm}^2$) transmit the low-energy radiation emitted by surface contamination into the detector interior, which is a thin, large-surface-area cavity. An argon-methane mixture slowly flows through the cavity and then is burned or recirculated with a small quantity of new gas. Argon is the counting gas, and methane lowers the operating voltage and quenches discharges between counter electrodes. Discharges caused by contaminants in the counting gas or by secondary emission from metallic counter parts cause electronic noise. The flat-slab geometry has a nonuniform electric field and gain so the instrument serves as a counter rather than an energy spectrometer. Although the very large gas-flow proportional counter is a noisy detector, its good low-energy response and low cost make it attractive for contamination monitoring where measurements can be repeated freely without significant penalty.

19.6 PERIMETER MONITOR COMPONENTS

The perimeter radiation monitor shown in Figure 19.1 monitors pedestrians, and that shown in Figure 19.12 monitors motor vehicles. Each monitor has similar components (Figure 19.13). The detectors sense radiation and transmit information to the monitor's control unit, which provides power, signal conditioning, and signal analysis. The control unit usually has an occupancy sensor to determine when to measure background and indicator lamps and sounders to announce alarms.

19.6.1 Components and Their Functions

The components and functions of a radiation monitor are described below:

- (1) Detector: Detect radiation from a particular region of space, usually the region between two or more detectors.
 - (2) Signal Conditioning Electronics: Transform the detected radiation charge pulses into voltage pulses that can be transmitted to another device for analysis.
 - (3) Single-Channel Analyzer (SCA): Select the pulses in a desired energy region. The output is a standard logic pulse.
 - (4) Control Unit: Count the SCA logic pulses. Use the result to derive alarm levels or monitoring measurements. Test background measurements against high- and low-background thresholds to detect malfunction. Display each new background result. Compare monitoring measurements to the alarm threshold (Section 19.4). Use the occupancy sensor to determine when to measure background and when to monitor. Assist with monitor calibration.
 - (5) Occupancy Sensor: Sense the presence of a person or vehicle and, if important, the direction of travel.
 - (6) Output Device: Communicate monitoring results by visual signals (flashing lights) and audible signals (chirps).
-

(7) Power Supplies: Convert line power to the direct-current voltages needed to operate the detectors and electronics.
Some of these devices and functions are discussed below in more detail.

19.6.2 Signal Electronics

Noise is present in any detection system and some of it can be eliminated by combining two voltage-level discriminators to form an SCA. An SCA acceptance window that is limited to a particular band of energies can optimize the performance of a radiation monitor. For example, because the intense part of the gamma-ray spectrum of highly enriched uranium lies in a narrow energy region, an acceptance window limited to that gamma-ray energy region gives the best detection sensitivity for uranium, even when such poor spectrometers as organic scintillators are used.



Fig. 19.12 *The components of this vehicle monitor carry out the same basic functions as a pedestrian monitor. (Manufactured by Jomar Systems, Inc., Los Alamos, New Mexico.)*

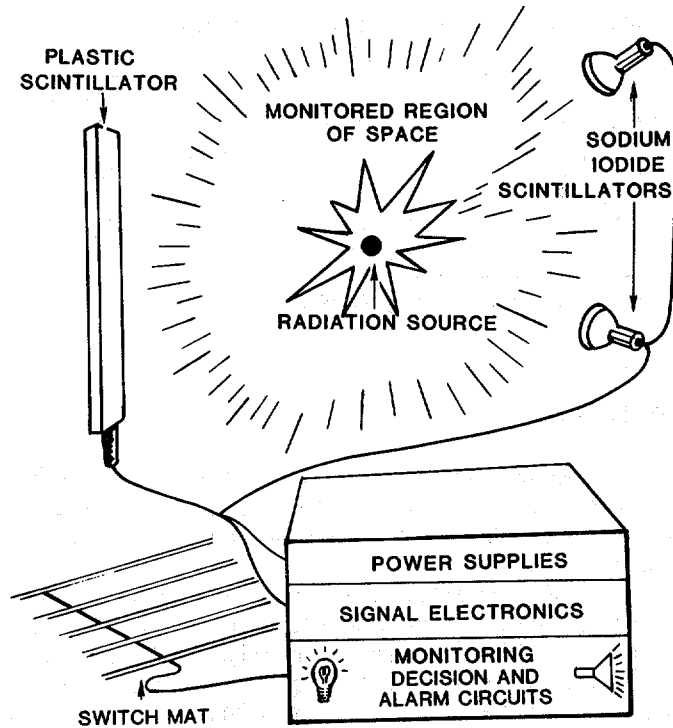

Fig. 19.13 *The basic components of a perimeter radiation monitor. The monitor must detect radiation, sense the presence of an occupant (with the switch mat), make decisions, and announce the result.*

Table 19-1 gives an example of how uranium detection sensitivity varies with the size of the acceptance window. The figure of merit in the table, S divided by the square root of B , relates the net signal S in a particular window to the standard deviation of the background in the same window. The greater the figure of merit, the easier it is to detect a uranium source and the lower is the minimum detectable quantity. For the values shown in the table, source detection was improved by about 50% with an optimum SCA window.

Scalers count the SCA logic pulses during a measurement period. Most scalars have counting intervals that match the average time that signals are present in a monitor. At the end of each counting interval, the scaler transfers its sum to the decision logic. When the monitor is unoccupied, many such sums are averaged to obtain a precise background value. During monitoring, each sum is compared to the alarm threshold.

Table 19-1. Figures of merit and detected mass for three SCA windows^a

SCA Window (V)	Energy Window (keV)	S/\sqrt{B}	²³⁵ U Mass Detected (g)
0.3-0.85	70-215	7.87	10
0.21-1.5	46-385	6.93	12.2
0.3-7.0	70-1735	6.0	15.2

^aSource, spherical masses; background, 21 μ R/h.

19.6.3 Power Supplies

High voltage for detectors is provided by a regulated electronic circuit that maintains an essentially constant output voltage. To use a single power supply for multiple scintillation detectors, each photomultiplier voltage-divider circuit is provided with a series potentiometer to adjust its gain.

Monitors using NIM electronic modules for amplifier, SCA, and high-voltage power supplies use low-voltage power from the NIM bin. Where microprocessor electronics are used, low-voltage power supplies can operate from trickle-charged batteries. This feature makes the monitor's controller insensitive to short-term power failure. Without back-up power, a monitor must restart after each power loss with some operating delay.

Some kind of back-up line power should be provided for the entire monitor in case of long-term power failure. This requirement is often met by facility back-up power; if not, it can be provided temporarily by commercial power units. In other cases, hand monitoring suffices as a back up during power outage.

19.6.4 Diagnostic Tests

Simple diagnostic tests can identify faults in radiation monitors as soon as they occur. The tests may be performed by separate modules or incorporated in the program of a microprocessor control unit. Background tests simply compare the measured background to high and low thresholds. A malfunctioning monitor may have a high or low background because of an inoperative or noisy detector. Inadvertent shielding of the detector or storage of radioactive material near the monitor will also be detected by a background test. To detect such anomalies as they occur, each new background value is usually checked and, if necessary, flagged by an audible or visual alarm.

More complex diagnostic techniques examine the monitor's counting statistics to determine if the counts originate from radiation detection or noise. Reference 13 describes a long-term analysis method that can diagnose noise even in the presence of sources or varying background intensity.

Variance analysis is suitable for short- or long-term analysis and is also used for detector calibration (Ref. 14). This technique calculates the mean and variance of a group of counts. If these quantities are nearly identical, the variance analysis test quickly

establishes that the detectors are operating properly. Noise can be detected in a single measurement set, and minor noise problems that may influence nuisance-alarm frequency can be detected by averaging the results for many sets.

19.7 MONITOR CALIBRATION

Improper calibration is a common cause of problems such as frequent nuisance alarms and lack of sensitivity. Calibration involves adjusting the detector gains so they all provide the same response to a calibration source and then adjusting the SCA to respond to radiation in the desired energy region. Gas counters require little calibration but scintillation detectors must be calibrated periodically.

19.7.1 Scintillation Detector Calibration

Calibrating a scintillation detector begins by setting the photomultiplier high voltage to a chosen value, typically 1000 V, and continues by adjusting each detector's gain potentiometer to obtain the same pulse-height response for a test source (for example, a 5- μ Ci ^{137}Cs source). The source is placed in the same way next to each detector and the pulse height is observed at the amplifier output with an oscilloscope. Next, the amplifier gain is adjusted to give the desired pulse amplitude; pulse heights between 2- and 4-V are commonly used for ^{137}Cs .

19.7.2 Single-Channel Analyzer Calibration

Both upper- and lower-level discriminators must be adjusted to form the SCA window. The upper-level discriminator can first be set to a desired value from Table 19-2 by using an oscilloscope. For monitoring plutonium, an upper level of 450 keV is appropriate; for highly enriched uranium, 220 keV.

The lower-level discriminator can be set in the same fashion to 60 keV; however, lower settings that are still above the noise may improve performance. One way to set lower values is to adjust the discriminator while making source-in and source-out intensity measurements until a maximum value of the figure of merit S/\sqrt{B} is achieved

Table 19-2. Gamma-ray pulse heights in NaI(Tl) and plastic scintillators^a

Gamma-Ray Energy (keV)	NaI(Tl) Detector Pulse Height (V)	Plastic Detector Maximum Pulse Height (V)
662	2	2
450	1.36	1.20
220	0.66	0.42
60	0.18	0.05

^aDetectors calibrated to 2-V pulse height for 662-keV gamma ray.

(Section 19.6.2). This slow procedure can be replaced by a variance analysis technique for much quicker results. The discriminator is decreased to the point where the variance analyzer just indicates noise, then it is raised slightly to the point where noise is no longer indicated.

19.7.3 Periodic Calibration Checks

A daily test is important to determine whether the monitor is functioning properly. If a low-intensity source (1 μCi of ^{133}Ba) is used for the daily test, both operation and calibration are verified. A more thorough test with nuclear material is performed on a quarterly basis. Additional information on monitor calibration is available in Reference 15.

19.8 MONITOR EVALUATION METHODS

Laboratory evaluation can verify a monitor's ability to detect radioactive material reliably and can reveal shortcomings in design. Summaries of evaluations have been published for pedestrian nuclear-material monitors (Ref. 16), for vehicle nuclear-material monitors (Ref. 7), and for contamination monitors (Ref. 3). These evaluations were carried out with monitors that were operated for long periods without recalibration while their statistical-alarm frequency and detection sensitivity were determined.

Statistical-alarm frequency and sensitivity are interdependent, and determining one has little meaning without determining the other. Statistical-alarm testing requires recording alarms in a constant background environment over a long enough period to observe 10^5 or more decisions. A timing switch is used to operate the monitor periodically, and the background is updated between monitoring periods. The statistical-alarm probability is obtained by dividing the observed number of alarms by the total number of monitoring tests performed. The statistical-alarm probability per passage of an occupant is then the product of statistical alarms per test and the average number of tests per passage. This type of testing ignores background reduction by an occupant, a factor that may overestimate the statistical-alarm frequency in normal operation.

Monitor sensitivity can be determined by observing the probability for a monitor to detect the passage of nuclear material or contamination test sources. The background intensity and the method of passing the test source through the monitor must be regulated, as well as other factors that affect performance. Because there is always some spatial variation in detector efficiency, testing should be done in the least sensitive part of the monitor; for example, at shoe level in a pedestrian monitor. The test source should be carried through the monitor by different individuals using their usual manner of walking. For a general discussion of monitor testing, see Ref. 17.

19.9 EXAMPLES OF PERIMETER MONITORS

19.9.1 Hand-Held Perimeter Monitors

Hand-held contamination monitors usually measure the dose rate for a single type of radiation, although some multipurpose instruments use filters or more than one type of detector to sense different types of radiation. Contamination monitors are simple, inexpensive, analog devices that are operated sporadically and are usually powered by batteries. Three contamination monitors are shown in Figure 19.14. Two of them monitor gamma radiation: the one at the left uses a NaI(Tl) detector and the one at the right uses a large-area Geiger-Mueller counter. The monitor at the center is a prototype, multipurpose instrument having detectors for four types of radiation including neutrons. This instrument (Ref. 18) addresses a need for a versatile monitor having standard field-maintenance and calibration procedures. The sensitivity of hand-held contamination monitors varies a great deal; most sense radiation intensities above $0.1 \mu\text{R/h}$, although NaI(Tl) monitors can operate at the natural background intensity of a few $\mu\text{R/h}$.

The three hand-held nuclear-material monitors shown in Figure 19.15 have scintillation detectors and battery operated electronics; two use NaI(Tl) detectors, and the one at the left uses a plastic scintillator. The instruments usually have rechargeable batteries and are operated continuously to monitor pedestrians and vehicles. Each monitor sounds an audible signal when it senses a significantly increased radiation intensity. Besides their use as perimeter monitors, these highly sensitive gamma-ray detecting instruments can be used as area radiation monitors or as survey monitors for salvaged

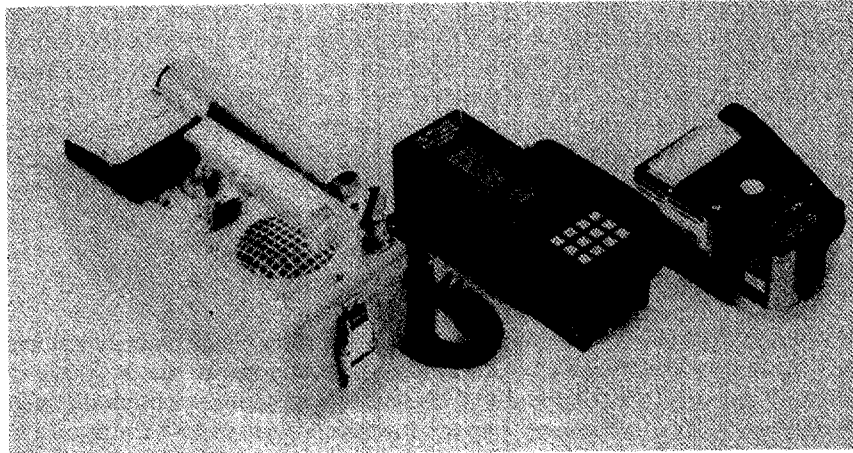

Fig. 19.14 Three different hand-held contamination monitors. From left: a NaI(Tl) gamma-ray survey meter, a multipurpose monitor with four detector types, and a Geiger-Mueller surface-contamination monitor. (Left- and right-hand units manufactured by Technical Associates, Canoga Park, California.)

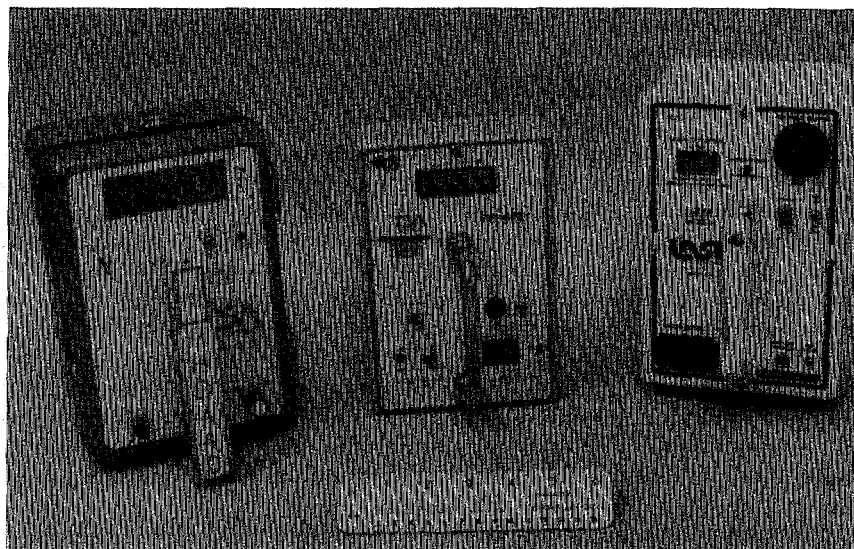

Fig. 19.15 Three hand-held nuclear material monitors that automatically detect significant intensity increases above background. (Left and center units manufactured by TSA Systems, Inc., Boulder, Colorado. Right-hand unit manufactured by CMS, Inc., Goleta, California.)

equipment. They sense radiation intensities of a few $\mu\text{R}/\text{h}$ and can detect about $0.5 \mu\text{Ci}$ of ^{137}Cs in a rapid but careful search (Ref. 19). They can detect a few grams of highly enriched uranium or a fraction of a gram of low-burnup plutonium under worst-case conditions. (Worst-case conditions are $25\text{-}\mu\text{R}/\text{h}$ background intensity and maximum self-absorption in the nuclear material.) Better performance will always be obtained under routine circumstances. Frequent statistical alarms, one or two per minute, are easily tolerated in these instruments because alarms in a specific area locate the radioactive material. Occasional alarms that are not repeated in the same area do not detract from monitoring effectiveness because they verify that the instrument is operating.

19.9.2 Automatic Pedestrian Monitors

Automatic contamination monitors for use with pedestrians are commercially available as traditional walk-through portals with gas-flow proportional counters that detect quantities below $1 \mu\text{Ci}$ of ^{137}Cs and as high-sensitivity wait-in monitors that detect quantities below 100 nCi of fission or activation products. Figure 19.3 illustrates a portal that achieves high sensitivity by requiring pedestrians to place their body surfaces against the proportional counters. The proximity between body surface and detector and an extended monitoring period both help to achieve high sensitivity.

Nuclear material walk-through monitors (Figure 19.1) can detect less than 10 g of highly enriched uranium and less than 0.3 g of low-burnup plutonium under worst-case operating circumstances. The typical statistical-alarm frequency is 1 per 4000 passages.

19.9.3 Automatic Vehicle Monitors

Automatic contamination monitors for use with vehicles are rare because the interior surfaces of a vehicle usually must be monitored closely. An exception is the roadbed monitor shown in Figure 19.16 that has a detector positioned below the vehicles to sense activated accelerator target material that may be transported from a facility. This Los Alamos monitor alarms at about twice background intensity. It provided the first evidence of contaminated Mexican steel introduced into the United States in 1983.

Automatic vehicle monitors for nuclear material range from simple drive-through portals as shown in Figure 19.17 to the complex station shown in Figure 19.12. Except for detector spacing, vehicle portals are similar to pedestrian portals. Moving-vehicle portals detect intensity increases of about 15% above background; for worst-case conditions, they can detect less than 10 g of low-burnup plutonium with less than 1 statistical alarm per 4000 passages under worst-case conditions.

Vehicles wait in the monitoring station shown in Figure 19.12 for a minute or less. The detectors are located in small groups above and below the vehicle, and each detector group is treated as a separate monitor with its own signal-conditioning and decision-logic electronics. The long monitoring time and the proximity of a detector group to the

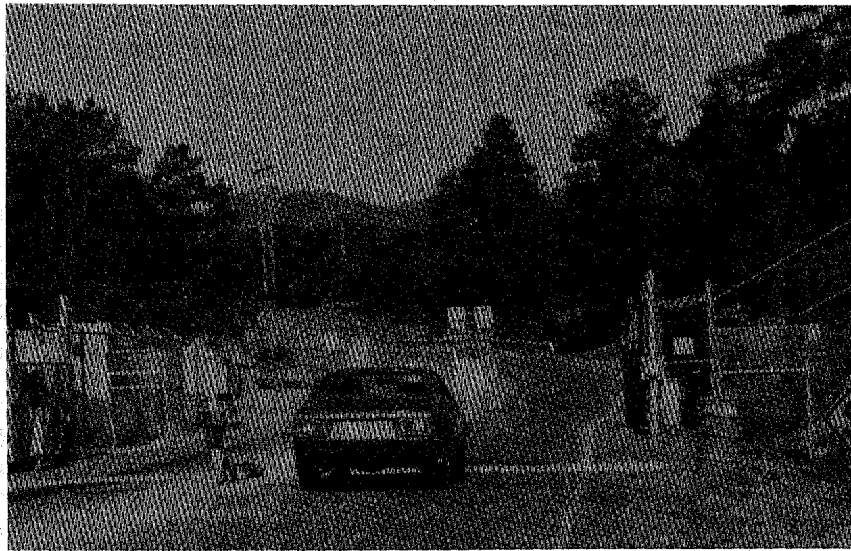

Fig. 19.16 *This vehicle monitor checks for activated material leaving an accelerator facility. Its underground detector triggers an alarm and photographs the vehicle when it senses a doubling of radiation intensity.*



Fig. 19.17 The nuclear-material portal monitor tests vehicles passing slowly (8 km/h) through the detector columns.

area being monitored lead to high sensitivity; the alarm threshold is about 5% above background to detect nuclear material quantities similar to those detected in pedestrian monitors.

19.9.4 Monitor Performance Summary

Tables 19-3 (Ref. 15) and 19-4 (Ref. 20) summarize the range of performance obtained in different nuclear material monitors. Table 19-3 lists mass detection categories for walk-through pedestrian monitors under worst-case conditions (defined in footnote a and Section 19.9.1) and at a statistical-alarm frequency of 1 per 4000 passages. The masses that can be detected are given for four performance categories, each of which requires particular combinations of detectors, portal spacing, and detection logic complexity.

The four performance categories in Table 19-3 are based on regulatory goals for detecting specified amounts of nuclear material. Category I requires the detection of 1 g of low-burnup plutonium at 25 $\mu\text{R}/\text{h}$ background intensity. This goal can be met with small detectors, portal spacings of 80 cm or more, and simple detection methods. Category II requires the detection of 10 g of highly enriched uranium, and Categories III and IV require performance better than present regulatory goals. Categories II through IV all require large detectors, portal spacings of 80 cm or less, and advanced detection algorithms. Note that the detection of smaller masses of nuclear material entails the

Table 19-3. Mass detection categories of walk-through nuclear material monitors (Ref. 15)^a

Category	Description	Uranium ^b (g)	Plutonium ^c (g)
I	Standard plutonium	64	1
II	Standard uranium	10	0.29
III	Improved sensitivity	3	0.08
IV	High sensitivity	1	0.03

^aTest conditions are 25 μ R/h background intensity, standard metallic test source attached below an interior ankle of an individual walking at his normal speed, and pace adjusted to swing the source through the monitor. Test results must give 95% confidence that the probability of detection is 50% or greater at a statistical-alarm rate of 1/4000 passages or better.

^bHighly enriched uranium.

^cLow-burnup plutonium freshly separated from daughter products, or shielded with 0.4- to 0.8-mm-thick cadmium.

Table 19-4. Worst-case mass detection sensitivity in nuclear material vehicle monitors (Ref. 20)

Vehicle Monitor Type	Minimum Detected Mass ^a		
	Low-Burnup Plutonium (g)	HEU (g)	Statistical-Alarm Rate ^b
Hand-held	3-9	100-300	1/100
Vehicle portal	10	1000	1/4000
Monitoring station	0.3	40	3/1000

^aUnder worse-case conditions in a 1-ton van that is stationary except in the 5-m-wide portal where it travels at 8 km/h. Background intensity is 20 μ R/h, and shielding by vehicle structures is highly significant. Detection implies a detection probability of 50% or greater. Better performance is obtained under routine circumstances.

^bStatistical rates are for an empty monitor.

detection of smaller signals. Hence, the higher categories are more sensitive to process-related background variations. Category III and IV monitors are only appropriate when the background is relatively constant.

Table 19-4 summarizes mass detection sensitivities for different types of vehicle monitors. These performance estimates are also for worst-case conditions (defined in footnote a and Section 19.9.1).

REFERENCES

1. EG&G Inc., Santa Barbara Division (R. W. Hardy, R. B. Knowlen, C. W. Sandifer, and W. C. Flake), US Patent No. 3,670,164, 1972.
 2. W. E. Kunz, "Portable Monitor for Special Nuclear Materials," Los Alamos Scientific Laboratory publication LASL-77-18 (1977).
 3. M. Littleton, "High Sensitivity Portal Monitors—A Review," Institute of Nuclear Power Operations report 82-001-EPN-01 (1982).
 4. US Department of Energy Order 5632.2, "Physical Protection of Special Nuclear Material," 1979.
 5. US Atomic Energy Commission Regulatory Guide 5.7, "Control of Personnel Access to Protected Areas, Vital Areas, and Material Access Areas," 1973.
 6. P. E. Fehlau, J. C. Pratt, J. T. Markin, and T. Scurry, Jr., "Smarter Radiation Monitors for Safeguards and Security," *Nuclear Materials Management XII* (Proceedings Issue), 294 (1983).
 7. P. E. Fehlau, C. Garcia, Jr., R. A. Payne, and E. R. Shunk, "Vehicle Monitors for Domestic Perimeter Safeguards," Los Alamos National Laboratory report LA-9633-MS (1983).
 8. A. Wald, *Sequential Analysis* (Dover Publications, Inc., New York, 1973).
 9. P. E. Fehlau, K. L. Coop, and J. T. Markin, "Application of Wald's Sequential Probability Ratio Test to Nuclear Materials Control," in Proceedings of Joint Specialists Meeting, ESARDA/INMM, Ispra, Italy, 1984.
 10. C. N. Henry and J. C. Pratt, "A New Containment and Surveillance Portal Monitor Data Analysis Method," *ESARDA* 10, 126-131 (1979).
 11. C. R. Hurlbut, "Plastic Scintillators—A Survey," presented at American Nuclear Society winter meeting, Nov. 1985 (available from Bicon Corp., Newbury, Ohio).
 12. P. E. Fehlau and G. S. Brunson, "Coping with Plastic Scintillators in Nuclear Safeguards," *IEEE Transactions on Nuclear Science* NS-30, 158 (1983).
 13. E. Appel, M. Giannini, and A. Serra, "A New Method of Self-Diagnosis for Pulse Measuring Systems," *Nuclear Instruments and Methods* 192, 341 (1981).
 14. K. V. Nixon and C. Garcia, "Hand-Held Pulse-Train-Analysis Instrument," *IEEE Transactions on Nuclear Science* NS-30, 331 (1983).
-

15. P. E. Fehlau, "An Applications Guide to Pedestrian SNM Monitors," Los Alamos National Laboratory report LA-10633-MS (1986).
 16. P. E. Fehlau, T. E. Sampson, C. N. Henry, J. M. Bieri, and W. H. Chambers, "On-Site Inspection Procedures for SNM Doorway Monitors," Los Alamos Scientific Laboratory report LA-7646 (NUREG/CR-0598) (1979).
 17. P. E. Fehlau, "Standard Evaluation Techniques for Containment and Surveillance Radiation Monitors," *ESARDA* 15, 195 (1982).
 18. C. J. Umbarger, G. O. Bjarke, B. H. Erkkila, F. Trujillo, D. A. Waechter, and M. A. Wolf, "New Generation of Radiacs: Small Computerized Multipurpose Radiation Monitors," *IEEE Transactions on Nuclear Science* NS-30, 528 (1983).
 19. P. E. Fehlau, "Hand-Held Search Monitor for Special Nuclear Materials, User's Manual," Los Alamos National Laboratory publication LALP-84-15 (1984).
 20. P. E. Fehlau, "An Applications Guide to Vehicle SNM Monitors," Los Alamos National Laboratory report LA-10912-MS (1987).
-
