

LA-10891-MS

2

Los Alamos National Laboratory is operated by the University of California for the United States Department of Energy under contract W-7405-ENG-36.

DO NOT CIRCULATE

**PERMANENT RETENTION
REQUIRED BY CONTRACT**

*Direct Oxide Reduction (DOR)
Solvent Salt Recycle in Pyrochemical
Plutonium Recovery Operations*

LOS ALAMOS NATIONAL LABORATORY



3 9338 0080 2537

Los Alamos Los Alamos National Laboratory
Los Alamos, New Mexico 87545

**Edited by Renate Lewin
Layout by Louise Maestas**

Manuscript prepared by Myrna P. Marsteller, Group MST-13

DISCLAIMER

This report was prepared as an account of work sponsored by an agency of the United States Government. Neither the United States Government nor any agency thereof, nor any of their employees, makes any warranty, express or implied, or assumes any legal liability or responsibility for the accuracy, completeness, or usefulness of any information, apparatus, product, or process disclosed, or represents that its use would not infringe privately owned rights. Reference herein to any specific commercial product, process, or service by trade name, trademark, manufacturer, or otherwise, does not necessarily constitute or imply its endorsement, recommendation, or favoring by the United States Government or any agency thereof. The views and opinions of authors expressed herein do not necessarily state or reflect those of the United States Government or any agency thereof.

LA-10891-MS

UC-10

Issued: February 1987

Direct Oxide Reduction (DOR) Solvent Salt Recycle in Pyrochemical Plutonium Recovery Operations

with
K. W. Fife ^{OK}
D. F. Bowersox ^{OK}
C. C. Davis ^{Ag (Charles C.)}
E. D. McCormick

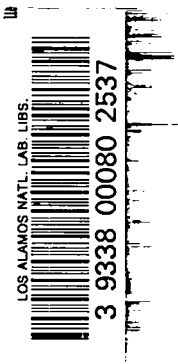

Los Alamos Los Alamos National Laboratory
Los Alamos, New Mexico 87545

DIRECT OXIDE REDUCTION (DOR) SOLVENT SALT RECYCLE
IN PYROCHEMICAL PLUTONIUM RECOVERY OPERATIONS

by

K. W. Fife, D. F. Bowersox, C. C. Davis, and E. D. McCormick

ABSTRACT

One method used at Los Alamos for producing plutonium metal is to reduce the oxide with calcium metal in molten CaCl_2 at 850°C . The solvent CaCl_2 from this reduction step is currently discarded as low-level radioactive waste because it is saturated with the reaction by-product, CaO . We have developed and demonstrated a molten salt technique for rechlorinating the CaO , thereby regenerating the CaCl_2 and incorporating solvent recycle into the batch PuO_2 reduction process. We discuss results from the process development experiments and present our plans for incorporating the technique into an advanced design for semicontinuous plutonium metal production.

INTRODUCTION

The Plutonium Metal Technology Group at Los Alamos (MST-13) routinely uses batch pyrochemical unit operations to produce and purify plutonium metal from a variety of impure feed sources.¹ These pyrochemical operations consist of controlling oxidation and reduction reactions (either chemical or electrochemical) between plutonium metal and its compounds in suitable molten chloride salts.

One method for producing plutonium metal from its oxide is to chemically reduce the oxide with calcium metal in molten CaCl_2 at 850°C . This process is called direct oxide reduction (DOR) and proceeds according to the general reaction²

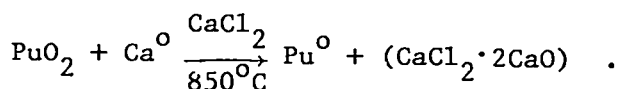

The DOR process is a batch operation in which the CaCl_2 acts as a heat sink during the exothermic reduction of PuO_2 , provides a medium to control the rate of reaction, and dissolves the CaO by-product to approximately 18 mol%.

The process does not perform any product purification, however, and impure reagents will result in impure metal product.

Because of the limited solubility of CaO in CaCl_2 , the solvent salts are discarded as low-level radioactive waste after each reduction. Developing a procedure to regenerate the spent salts offers numerous advantages;³ briefly they include

- o reduction in process waste from DOR,
- o improvement in overall process yields,
- o potential for producing a pure solvent salt,
- o increased possibility for producing a pure plutonium product from pure reagents, and
- o aid in the development of a process for semicontinuous plutonium metal production.

In a research setting we have developed and demonstrated a technique to regenerate spent DOR salt on a batch basis. We have also performed more than a hundred oxide reductions using regenerated salt with essentially the same DOR process yield obtained by our production DOR process. We feel that this constitutes a sufficient data base to illustrate the feasibility of salt regeneration and recycle on a batch basis.

In theory, the regeneration of spent DOR salts could be accomplished through any of three approaches: the electrolytic reduction of CaO and subsequent recovery of the calcium metal,⁴ precipitation of CaO , or the chemical conversion of CaO to CaCl_2 using an appropriate chlorinating agent. Preliminary work at Argonne National Laboratory on the electrolytic reduction of CaO was promising, but it was felt too much time was required for proper cell design and development.

Precipitation studies were unsuccessful because of poor phase separation and incomplete CaO solute removal from the CaCl_2 solvent. The final approach, CaO chlorination to CaCl_2 , appeared promising from initial experiments.⁵

Experiments designed to chlorinate CaO used several potential chlorinating agents. Those agents that failed because of either incomplete chlorination or contamination with unwanted impurities were ammonium chloride and carbon tetrachloride. Both ZnCl_2 and MgCl_2 were effective reagents but both left behind their respective oxides that needed removal before the CaCl_2 could be effective in DOR. Our best experience was obtained using the gaseous reagents anhydrous HCl, chlorine and phosgene (COCl_2).

Regeneration experiments on synthetic, spent DOR salts (CaCl_2 -10 wt% CaO or CaCl_2 -10 wt% CaO-1 wt% Ca^0) indicated that CaO alkalinity can be effectively removed by any of the three reagents (Fig. 1). But since residual oxygen* in the final salt will react with calcium metal in DOR to form CaO, the residual oxygen profiles shown in Fig. 2 are better indicators of regeneration efficiency. These profiles illustrate the difficulty in removing residual oxygen from the system. Regeneration with chlorine results in the best performance, followed by HCl and then phosgene.

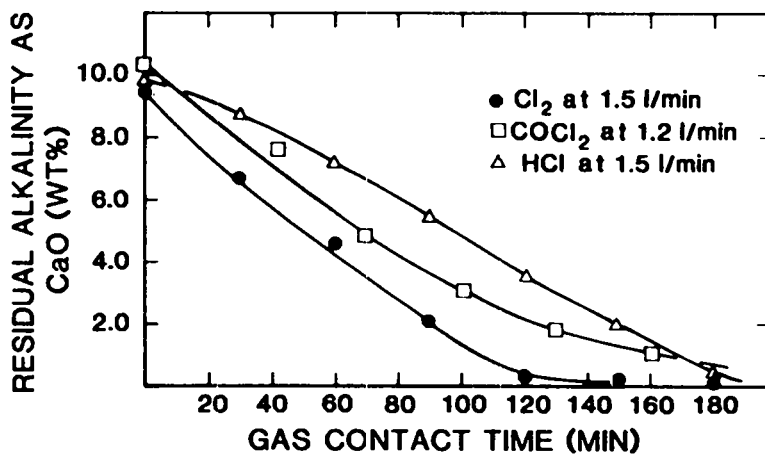

Fig. 1. Residual calcium oxide in regenerated salts.

* Residual oxygen values were determined by neutron activation on non-radioactive salt samples only.

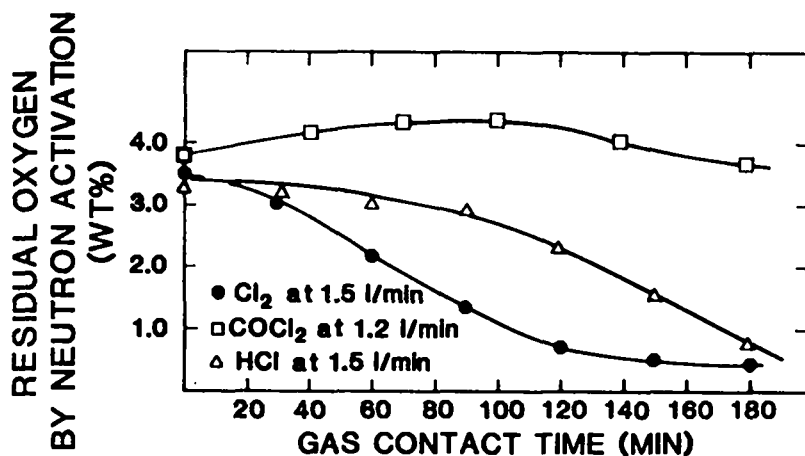

Fig. 2. Residual oxygen in regenerated salts.

As a result of these initial development experiments using synthetic, spent salts, the regeneration procedure was transferred into the plutonium environment and experiments were begun using actual spent process salts.

Because of our long-range goal to convert the DOR process from a purely batch to a semicontinuous operation by regenerating and recycling spent salts, we felt it necessary to accomplish regeneration of a full-scale DOR salt in approximately 2 h. This regeneration time would provide the basis for advanced process development.

The success of this recycle program depends on maintaining or improving salt quality during regeneration. Plutonium is an active metal solvent and tends to strip metal impurities from salt (Table I). This reaction is one principal reason why the DOR process has not been able to produce a "pure" metal (>99.95%) from "pure" reagents. If we can regenerate a salt while maintaining or improving its quality, then pure-metal production from this process is more realistic.

TABLE I. ESTIMATES OF ELEMENT SOLUBILITIES IN PLUTONIUM
AT 800°C (Ref.6)

Element	Atom %	Wt%	Element	Atom %	Wt%
Silver	6.5	2.6	Niobium	1.5	0.6
Aluminum	10.0	1.2	Nickel	45.0	16.7
Gold	7.0	5.8	Lead	14.0	12.4
Beryllium	7.0	0.3	Platinum	9.0	4.2
Bismuth	8.5	7.5	Rhenium	2.4	1.8
Carbon	2.3	0.1	Rhodium	19.0	9.2
Cadmium	1.0	0.5	Silicon	7.5	0.9
Cobalt	38.0	13.1	Tin	0.9	0.4
Chromium	3.3	0.7	Tantalum	0.2	0.1
Copper	52.0	22.4	Titanium	22.5	5.5
Iron	27.0	8.0	Thulium	4.1	2.9
Gallium	23.0	8.0	Vanadium	1.5	0.3
Hafnium	11.0	8.4	Tungsten	0.01	0.01
Magnesium	22.5	2.9	Yttrium	16.0	6.6
Manganese	30.8	9.3	Zinc	30.0	10.5
Molybdenum	2.8	1.1	Zirconium	5.4	2.1

REGENERATION AND RECYCLE PROCEDURE

For both plutonium and nonplutonium environments, the method used in regeneration experiments is to place the spent salt in a 15-cm-o.d. by 38-cm-tall vitrified magnesia crucible nested in a stainless steel containment can inside a stainless steel furnace tube (Fig. 3).

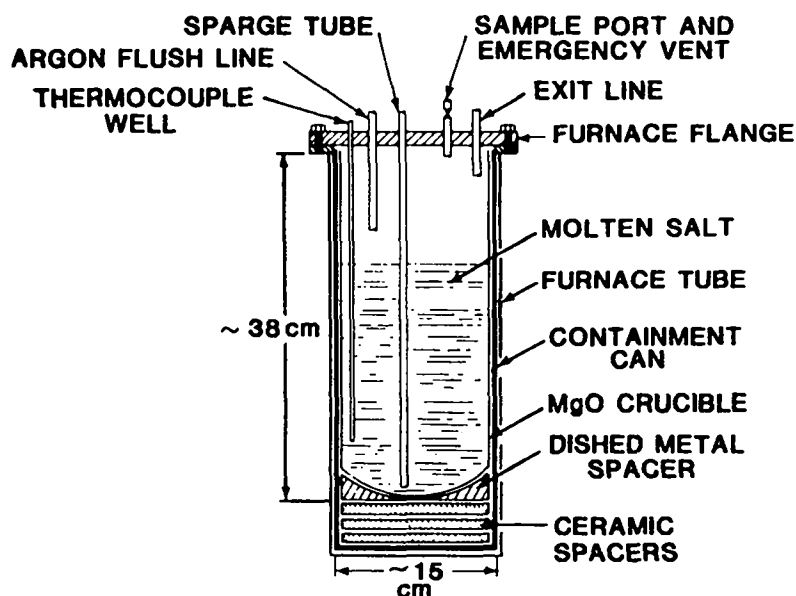

Fig. 3. Apparatus for spent-salt regeneration.

After an argon atmosphere is placed above the salt, the apparatus is resistance-heated to 850°C using a Lindberg model 6015S furnace. The metal is sparged for a fixed time at a fixed flow rate with either anhydrous HCl or chlorine through alumina or magnesia tubing. Samples are withdrawn at selected intervals using quartz tubing to determine CaO conversion profiles. After chlorination, the system is purged with argon, and the salt is vacuum-transferred⁷ through tantalum tubing to ambient-temperature aluminum split molds for final shaping and cooling (Fig. 4). All off-gas from regeneration is directed through a caustic scrubber system before venting to the glovebox atmosphere. The scrubber system consists of a series of three pyrex bubble columns containing 4 M KOH. The lead scrubber is ~ 10 cm o.d. by 38 cm tall and contains ~ 2 l KOH, followed by two scrubbers containing about 1 l each.

Our recycle procedure is identical to the production DOR operating procedure. When the regenerated salt has cooled under argon it is placed along with calcium metal and PuO_2 into another 15-cm-o.d. by 38-cm-tall vitrified magnesia crucible. The crucible is placed into the equipment shown in Fig. 5 and covered with argon. A resistance furnace heats the reagents to 800°C and a tantalum stirrer and tantalum-nickle thermocouple well are lowered into the

melt. Once stirring is initiated, the reaction proceeds to completion in about 5 min. After the temperature has stabilized, stirring is stopped and the stirrer and thermocouple well are removed from the melt. The system is kept at temperature for another 10 min to allow metal coalescence before cooling and recovery of the metal product (Fig. 6).

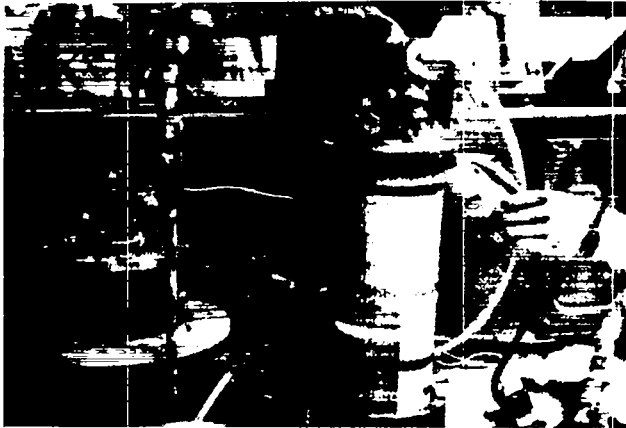

Fig. 4. Vacuum-transfer apparatus and cast of the regenerated salts.

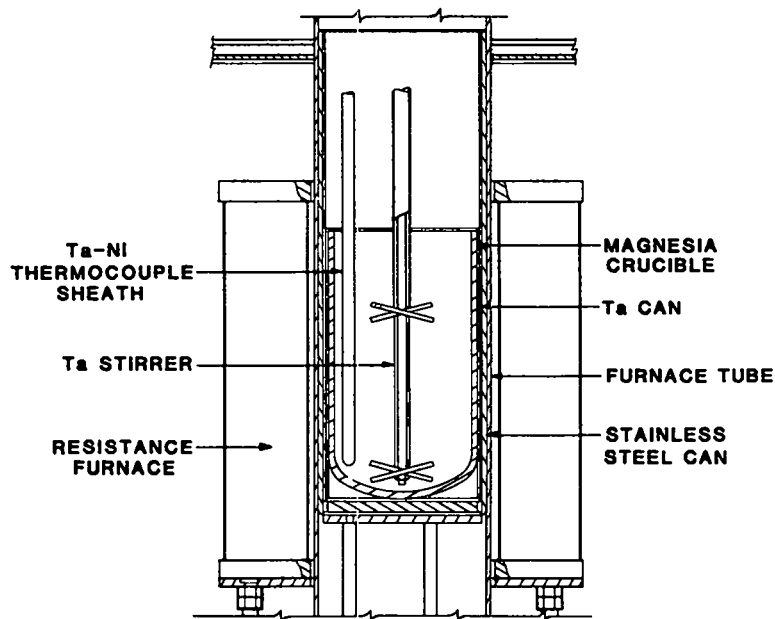

Fig. 5. DOR process equipment.

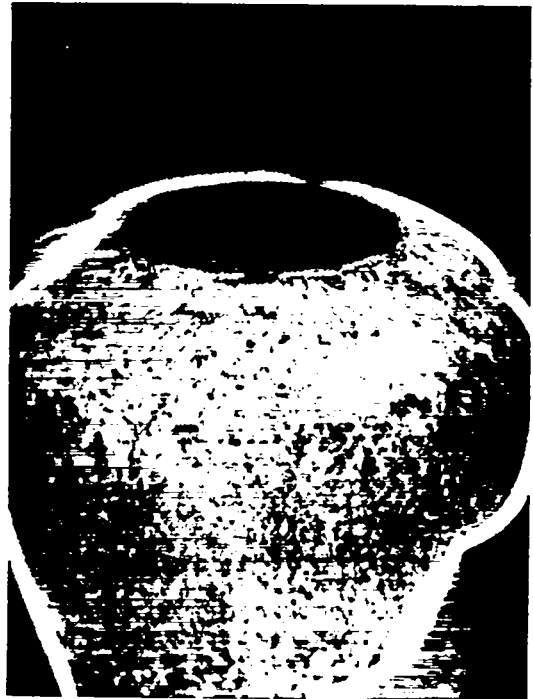
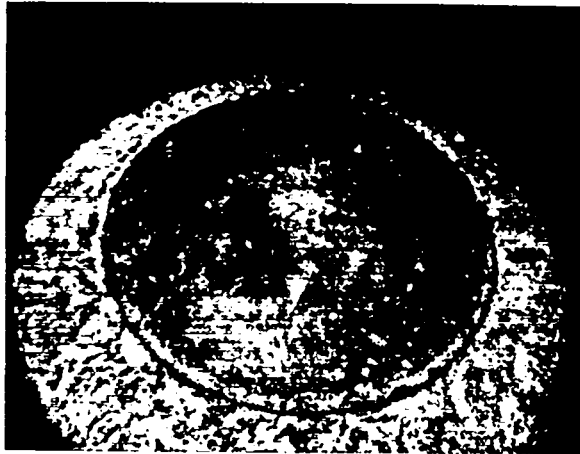

Fig. 6. DOR product buttons from regenerated salt.

RESULTS

We currently regenerate a spent DOR salt in ~ 2 h with chlorine or HCl at flow rates between 3 and 5 ℓ/m . At these flow rates both reagents are effective regenerants. Chlorine, however, produces a better quality salt based on regeneration and recycle performance, and it has become our reagent of choice (Fig. 7).

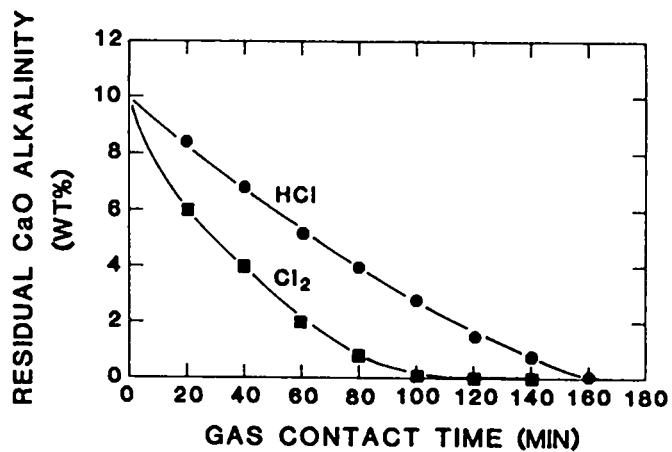

Fig. 7. Salt regeneration profiles with HCl and Cl₂ at 4 ℓ/m .

Minimizing or eliminating the introduction of metallic impurities during regeneration has always been an area of interest.⁸ We need to maintain high quality in the regenerated salt to keep the purity of our final plutonium metal product high. The corrosive nature of chlorine on wetted ceramic parts results in elevated magnesium concentrations (<2000 ppm) in the final salt, and in aluminum concentrations approaching 300 ppm when alumina hardware is used. In addition to these elements, we have found occasional high concentrations of stainless steel components present after regeneration (a total of 500-1000 ppm Fe, Cr, Ni, Mn) and some yttria, presumably from ceramics used in the system.

We believe stainless steel impurities result from corrosion of metal hardware caused by circulation of the corrosive off-gas in the vapor space above the salt. We have minimized this corrosion with several minor system changes. We replaced the top furnace flange with either Hastelloy C276 or Inconel 625, raised the magnesia vessel as high as possible in the furnace tube, diluted the chlorine regenerant with argon, and introduced another argon flush line to the furnace to sweep the vapor space and force the off-gas out of the system quickly (Fig. 3). We could reduce the alumina concentration by switching to an all-magnesia system, but have yet to find a commercial supplier of reliable magnesia tubing. The magnesia contamination continues, however, and reduces to magnesium metal during the recycle step. Some volatilizes and collects in the cooler vapor space of the furnace, and some collects with the plutonium metal product, forming a calcium-magnesium-plutonium layer on the metal surface (Fig. 8).

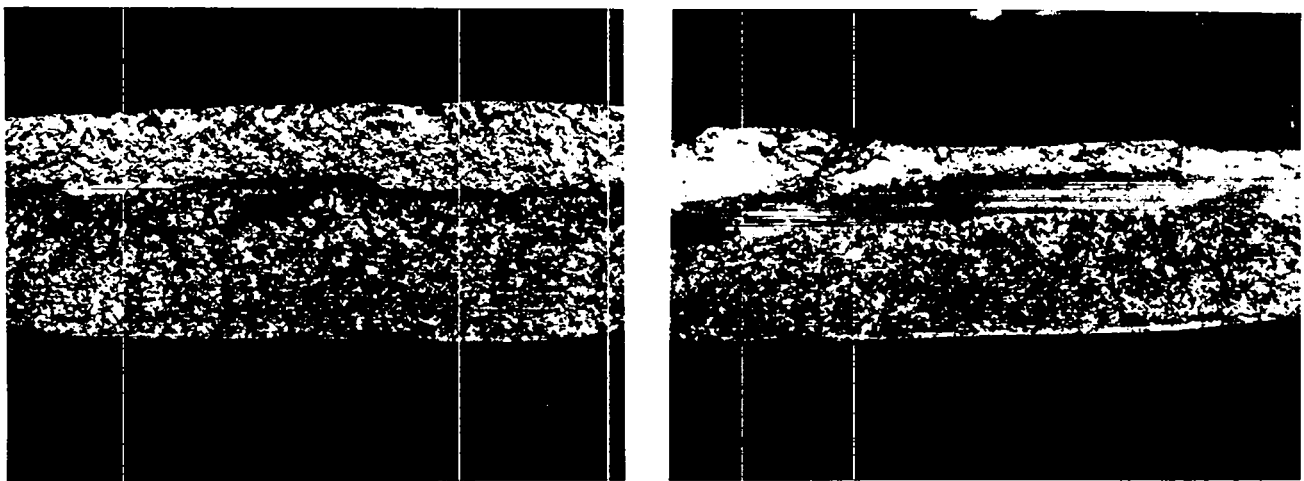

Fig. 8. Cross section of DOR button (oxidized to illustrate phases).

The purities of some typical regenerated salts are listed in Tables II and III. Both tables reflect 2-h salt regeneration with diluted chlorine ($Cl_2:Ar$ ratio of 3:2), a magnesia reaction vessel, and stainless steel containment vessels. Table II, however, illustrates regeneration with a magnesia sparge tube and a top furnace flange constructed of Hastelloy C276.* Table III lists salt purity data using an alumina sparge tube and a top furnace flange constructed of Inconel 625.**

We are encouraged by these data since the only impurities we are adding to the salts are those resulting from ceramic corrosion or dissolution during regeneration. We are continuing to investigate parameter changes in hopes of further lowering these values, but realize that the optimum process may include ceramic impurities in the final salt. We are also continuing to investigate potential metal candidates for vessel construction but have yet to find a material superior to vitrified magnesia.

The technique we have developed to regenerate spent DOR salts has been very effective in reducing process waste on a research scale. As a result of this successful development program, we initiated a short-term production demonstration in our research area aimed at evaluating the technique on a daily basis while performing regeneration and recycle. We rotated two salts between regeneration and recycle for a total of five campaigns; each campaign ended when the total product metal from oxide reduction approached 6 kg - the amount necessary for the downstream processes ingot casting and purification by electrorefining.

Results of these five campaigns are presented in Table IV.

* Nominal composition of Hastelloy C276 (wt%): Ni, 16Cr, 15Mo, 5Fe, 3.7W, 1.4Co, 1Mn

** Nominal composition of Inconel 625 (wt%): Ni, 20Cr, 9Mo, 5Fe, 4(Nb + Ta)

TABLE II. SALT PURITY RESULTS FOR SOME REGENERATED SALTS
USING MgO-WETTED HARDWARE AND A HASTELLOY C276 FURNACE HEAD

- o 3:2 Cl₂/Argon dilution
- o Magnesia sparge tube
- o Magnesia crucible
- o Hastelloy C276 furnace head
- o 2-h regeneration
- o Stainless steel pull can and furnace tube
- o Analysis values in ppm

Run Number	Al	B	Cr	Cu	Fe	Mg	Mn	Ni	Ta	Y	Alkalinity As CaO (wt%)
85-initial	30	<3	4	3	20	40	5	4	<100	60	7.39
85-final	30	<3	4	3	50	60	5	<4	<100	50	3.85
86-initial	12	<3	<4	3	20	20	<1	<4	<100	60	7.01
86-final	15	<3	5	2	20	500	4	<4	<100	30	<0.01
88-initial	4	<3	<4	1	12	15	<1	<4	<100	30	5.86
88-final	12	<3	<4	1	8	600	<1	<4	<100	50	<0.01
90-initial	5	<3	4	25	100	40	1	<4	<100	20	5.69
90-final	5	<3	10	2	100	1000	2	<4	<100	20	0.02
91-initial	4	<3	<4	25	4	12	<1	<4	<100	30	5.80
91-final	<4	<3	<4	3	20	1000	1	<4	<100	25	<0.01
92-initial	<4	<3	<4	1	10	40	<1	<4	<100	20	7.61
92-final	10	<3	<4	1	100	4000	1	<4	<100	80	0.92
93-initial	<4	<3	5	1	40	20	<1	<4	<100	10	5.87
93-final	<4	<3	<4	1	8	600	4	<4	<100	10	0.03
94-initial	4	<3	<4	1	6	25	<1	<4	<100	15	8.61
94-final	5	<3	4	40	40	100	1	<4	<100	15	0.05
103-initial	<4	<3	<4	2	12	50	<1	<4	<100	35	6.03
103-final	4	<3	4	2	20	300	<1	<4	<100	10	0.06
106-initial	4	<3	<4	2	20	30	<1	<4	<100	50	6.04
106-final	80	<3	4	1	15	500	2	<4	<100	50	0.02

TABLE III. SALT PURITY RESULTS FOR SOME REGENERATED SALTS
USING MgO/Al₂O₃-WETTED HARDWARE AND AN INCONEL 625 FURNACE HEAD

- o 3:2 Cl₂/Argon dilution
 - o Alumina sparge tube
 - o Magnesia crucible
 - o Inconel 625 furnace head
- o 2-h regeneration
 - o Stainless steel pull can and furnace tube
 - o Analysis values in ppm

Run Number	Al	Cr	Cu	Fe	Mg	Mn	Ni	Ta	Y	Alkalinity As CaO (wt%)
65-initial	85	5	<1	25	350	<1	4	<100	100	7.25
65-final	250	4	<1	20	350	<1	<4	<100	100	0.06
66-initial	6	<4	<1	50	250	<1	4	<100	12	7.72
66-final	250	<4	<1	12	350	<1	<4	<100	40	<0.01
67-initial	12	4	<1	25	40	<1	<4	<100	60	7.03
67-final	100	<4	1	10	3500	1	<4	<100	40	0.08
68-initial	12	<4	1	10	12	<1	<4	<100	40	7.29
68-final	100	5	1	40	2000	3	<4	<100	40	0.04
69-initial	12	<4	1	4	12	<1	<4	<100	40	6.66
69-final	75	4	1	10	350	<1	<4	<100	40	<0.01
70-initial	6	<4	<1	7	100	<1	<4	<100	60	7.28
70-final	85	<4	<1	6	2500	<1	<4	<100	60	<0.01
71-initial	6	<4	<1	12	60	<1	<4	<100	60	6.88
71-final	120	<4	<1	6	600	<1	<4	<100	60	<0.01
72-initial	6	<4	<1	<4	12	<1	<4	<100	60	6.30
72-final	250	<4	<1	25	500	<1	<4	<100	60	<0.01
73-initial	20	<4	<1	20	40	<1	<4	<100	60	6.45
73-final	200	4	6	100	1000	12	<4	<100	60	<0.01
74-initial	40	<4	<1	6	35	<1	<4	<100	25	9.56
74-final	120	<4	<1	6	350	<1	<4	<100	60	0.02

TABLE IV. DOR SALT RECYCLE -
RESULTS OF DEMONSTRATION ACTIVITIES
(BATCH REGENERATION AND RECYCLE)

	<u>Campaign</u>				
	<u>1</u> Pure PuO ₂	<u>2</u> Foundry PuO ₂	<u>3</u> Foundry PuO ₂	<u>4</u> Foundry PuO ₂	<u>5</u> Foundry PuO ₂
Feed					
Product to Casting, kg	5.5	6.0	5.9	5.7	6.0
DOR process yield, % Pu	96.6	98.8	99.1	95.8	98.3
Plutonium to waste, % Pu	2.5	1.2	0.5	1.9	1.6
* Plutonium in process, % Pu	0.9	0	0.4	2.3	0.1
Plutonium to recycle, % Pu	1.0	0.8	0	0.4	1.3
Excess calcium, in DOR, %	50	30	30	20	25
Reduction in salt and crucible process waste, %	51.2	53.8	49.5	45.4	52.7
Salt fraction in waste, %	18.6	12.9	14.7	21.9	11.7
Crucible frac- tion in waste, %	81.4	87.1	85.3	78.1	88.3
Spent caustic, l	17.5	12.5	7.5	7.5	7.5
Chlorine/argon dilution at 3 l/min for ~2 h	100%Cl ₂	3:2	3:2	3:2	3:2

* This value includes nondestructive analysis error, chemical analysis variability, and plutonium adhering to hardware (stirrers, thermocouple wells, etc.), factors that are normally not included in incremental accountability practices.

Throughout the demonstration period (more than 50 cycles), the same two salts were used for regeneration and recycle. Overall DOR process yields were similar to those experienced in production DOR where the salt is discarded after each use. The first campaign was a continuation of early development experiments using pure PuO_2 as feed for DOR (to reduce process variables), 50% excess calcium (similar to production DOR historic use), 100% chlorine as the regenerant (historic use), and with no concerted effort to conserve reagents and further reduce waste (high excess calcium, high chlorine use, large volumes of spent caustic generated). Subsequent campaigns, however, illustrate our attempts at improving the process in these areas. We have successfully reduced the excess calcium in DOR without affecting PuO_2 reduction yields; we switched from pure PuO_2 to foundry PuO_2 (this impure, refractory PuO_2 is historically the feed for DOR), and we began diluting the chlorine with argon and also began improving our utilization of the caustic scrubber solution.

One of the main advantages of the recycle technique is to reduce the overall spent salt waste from DOR. These five campaigns indicate that reductions in waste of around 50% are possible from the batch technique. In theory, the amount of calcium fed to DOR goes to regeneration as either CaO or excess calcium metal. This amount needs to be bled from the process as CaCl_2 to maintain a constant salt balance in the system (assuming 100% calcium metal conversion to CaCl_2). With 50% excess calcium in DOR, this bleed stream is close to 20%; with 20% excess calcium the value is approximately 16%. This means that the maximum reduction in process waste from DOR could be around 80-85%.

Actual operating experience with this batch technique, however, increases process waste for the following reasons:

- o When calculating the overall reduction in process waste for Table IV, regeneration is assumed to be a part of the DOR process. We currently discard a magnesia crucible after regeneration which is counted in the waste stream calculation and reduces its value.

- o The liquid spent caustic waste is not currently included in the process waste stream calculations. It would also reduce the value.
- o The ceramic vessels used in oxide reduction and regeneration occasionally fail during a run. This causes us to discard the entire salt because of the excessive contamination with stainless steel products and our inability to remove all of the MgO crucible fragments from the salt. This increases DOR process waste.
- o Other waste sources not included in the waste stream calculations consist mainly of scrubber glassware, furnace elements, and nonplutonium metal scrap (furnace tubes, pull cans, stirrers, thermocouple wells, transfer tubes, etc.). This also increases waste.
- o Excess calcium metal is not completely converted to CaCl_2 . Buoyant calcium floating on the surface of the CaCl_2 during regeneration is effectively pushed to the crucible walls when the gas stream breaks the molten salt surface, resulting in inefficient gas/liquid contacting (Fig. 9). This reduces the CaCl_2 bleed stream and ultimately complicates the system from a waste disposal standpoint. Free calcium metal in waste streams is unacceptable for long-term storage because of its hydrogen-generation potential if exposed to water.

In summary, we are very encouraged by the results of this short-term production demonstration using regenerated salts in DOR. To date, we have some data on the performance of the product plutonium metal in the downstream processes of ingot casting and electrorefining. Currently, performance in both processes appears to be very similar to historic performance of conventional DOR product metal.

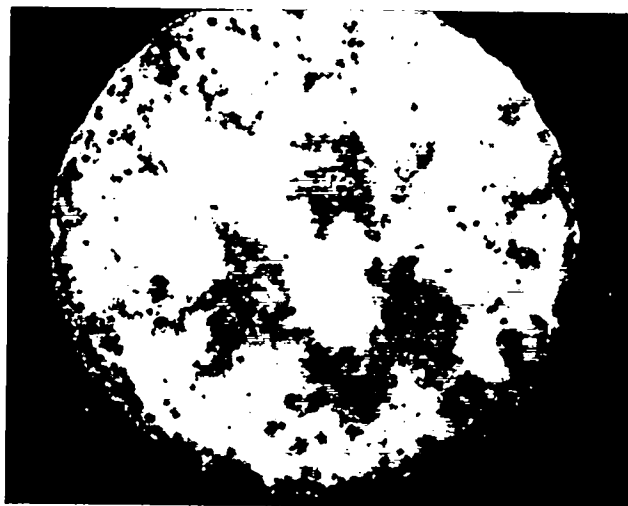
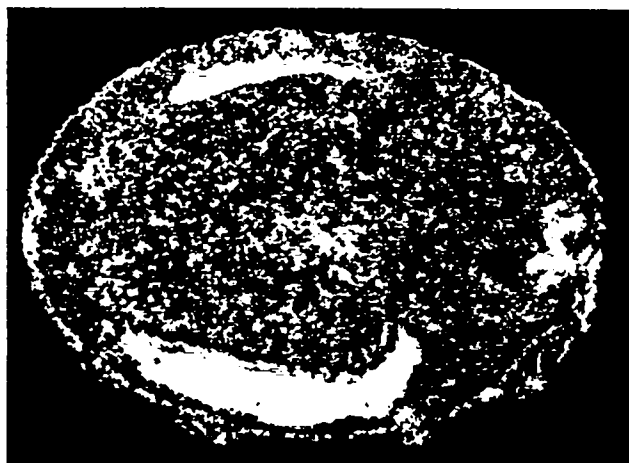

Fig. 9. CaCl_2 regenerated salt with unreacted Calcium.

DOR salt regeneration and recycle is being developed as a stand-alone batch process capable of producing a reusable solvent salt for DOR. Our ability to vacuum-transfer and cast molten salts not only allows us to control the geometry of the DOR feed salt, but will be relied on in our advanced DOR processing concept. We are optimizing DOR and plan to convert the process from a batch to a semicontinuous operation. We initially plan to use three furnaces and transfer molten salt between them. This eliminates lost processing time through furnace heating and cooling (Fig. 10).

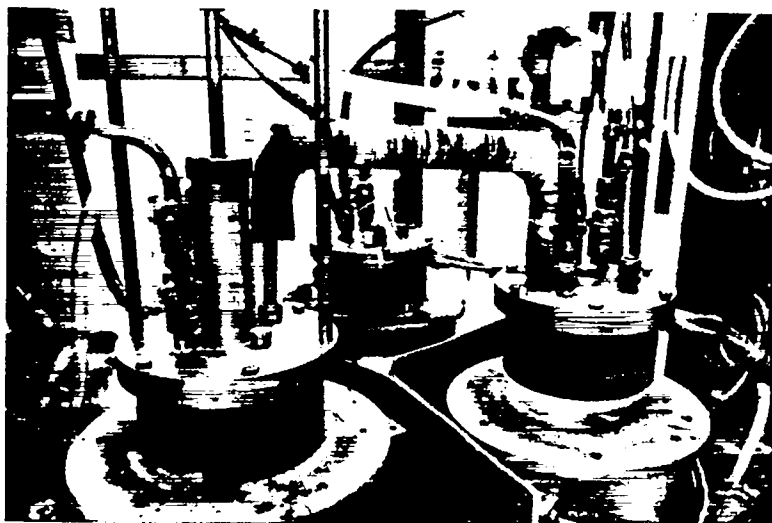

Fig. 10. Semicontinuous salt recycle and oxide reduction apparatus.

Oxide reduction will be performed in one vessel while the other two will be regeneration vessels. This is the preferred scheme because DOR is about a

20-min operation whereas regeneration takes ~2 h. Recently we have been successful in multiple cycles of oxide reduction using lead oxide as a substitute for PuO_2 (Table V). We accomplished salt transfer, regeneration, and salt transfer back for oxide reduction without the intermittent furnace cooling necessary in the batch process.

Table V illustrates our learning curve with this new process. The important aspect of these data lies in our ability to efficiently recover product lead metal after completing successive salt cycles. Product metal recovery was accomplished primarily through cooling and subsequent product breakout. On a few occasions, however, we were successful in recovering the product by vacuum transferring and casting the molten metal.

TABLE V. RESULTS FROM THE SEMICONTINUOUS REDUCTION OF Pb_3O_4 TO LEAD METAL USING SOLVENT SALT REGENERATION AND RECYCLE

Reduction: Approximately 1/2-scale DOR with Pb_3O_4 and CaCl_2 ; 40% excess Ca^0

Regeneration: Chlorine at 3 l/min for ~2 h

Run	Reduction Cycles	Regeneration Cycles	Metal Recovery %	Operating time, h
CR3	2	3	54*	6.0
CR4	2	2	57*	4.5
CR7	1	2	94*	3.5
CR10	3	4	98*	5.0
CR11	3	3	95**	5.0

* Broken ceramic reduction vessel.

** Comparable full-scale reduction of Pb_3O_4 . Reduction vessel not broken at end of series.

These initial experiments have also been useful in defining certain deficiencies in our process, which are current topics of investigation. These plans include

- o improving reliability in the vacuum-transfer device - we must develop the capability to unplug transfer tubes in the glovebox using no water;
- o investigating compatible metal reaction vessels for oxide reduction and regeneration. The breakage of ceramic vessels in the semicontinuous process interrupts continuity in salt transfer and/or plutonium metal recovery;
- o considering product metal handling alternatives. Can it be allowed to accumulate in the DOR vessel or must it be periodically removed?

FUTURE DIRECTION

We are transferring batch regeneration and recycle into our production area for long-term process demonstration and evaluation. In conjunction with production demonstration, we plan to continue investigations into the following areas:

- o evaluation of operating parameters; chlorine/argon dilution, regeneration time, and excess calcium in DOR.
- o upgrade of vacuum-transfer tubes for reliable glovebox use.
- o investigation of alternate materials of construction for reaction vessels. Both regeneration and oxide reduction vessels should be reusable and compatible with their respective environments.
- o design and testing of an external scrubber for treating regeneration off-gas. Material for this system must be compatible with radioactive alkaline, oxidizing chloride solutions.

- o investigation of semicontinuous metal production techniques. The successful development of a process will depend on answering questions involving materials compatibility, equipment development, and off-gas handling.

These items must be resolved in order for semicontinuous DOR to be seriously demonstrated in production. Even if our semicontinuous process cannot be developed because of these problems, the batch regeneration and recycle of spent DOR salt will remain an attractive alternative for reducing process waste.

ACKNOWLEDGMENTS

Without the help of dedicated technicians who routinely performed and commented on these experiments, the development of DOR salt recycle would have suffered. For these reasons and more, we would like to thank A. E. Buchholz, M. J. Chavez, W. K. Drennon, D. W. Anderson, J. Y. Coulter, J. J. Simpson, and B. J. Phillips for their contributions in early development activities.

We would also like to thank personnel at CLS-1, our analytical chemistry group, for their timely and revealing analytical support. Without results from the hundreds of salt samples we generated to support this project, process development could not have been accurately accomplished in any reasonable time.

REFERENCES

1. D. C. Christensen and L. J. Mullins, "Present Status of Plutonium Metal Production and Purification at Los Alamos-1982," Los Alamos National Laboratory report LA-9674-MS (June 1983).
2. L. J. Mullins, D. C. Christensen, and B. R. Babcock, "Fused Salt Processing of Impure Plutonium Dioxide to High-Purity Plutonium Metal," Los Alamos National Laboratory report LA-9154-MS (January 1982).
3. M. S. Coops and D. F. Bowersox, "Nonaqueous Processing Methods," Los Alamos National Laboratory report LA-10169-MS (September 1984).
4. R. E. Barletta et al., "Molten Salt Recycle, Electrolysis of CaO in Molten Salt," Argonne National Laboratory report ANL-79-99 (April 1979).
5. K. W. Fife, D. F. Bowersox, and E. D. McCormick, "Comparison of Phosgene, Chlorine, and Hydrogen Chloride as Reagents for Converting Molten $\text{CaO} \cdot \text{CaCl}_2$ to CaCl_2 ," Los Alamos National Laboratory report LA-10523-MS (September 1985).
6. F. H. Ellinger, W. H. Miner, D. R. O'Boyle, and F. W. Schonfeld, "Constitution of Plutonium Alloys," Los Alamos Scientific Laboratory report LA-3870 (December 1968).
7. K. W. Fife, D. F. Bowersox, D. C. Christensen, and J. D. Williams, "The Preparation of Fused Chloride Salts for Use in Pyrochemical Plutonium Recovery Operations at Los Alamos," Los Alamos National Laboratory report LA-10681 (July 1986).
8. C. E. C. Rense, K. W. Fife, D. F. Bowersox, and M. D. Ferran, "Materials Compatibility During the Chlorination of Molten $\text{CaCl}_2 \cdot \text{CaO}$ Salts," Los Alamos National Laboratory report LA-10700-MS (in preparation).

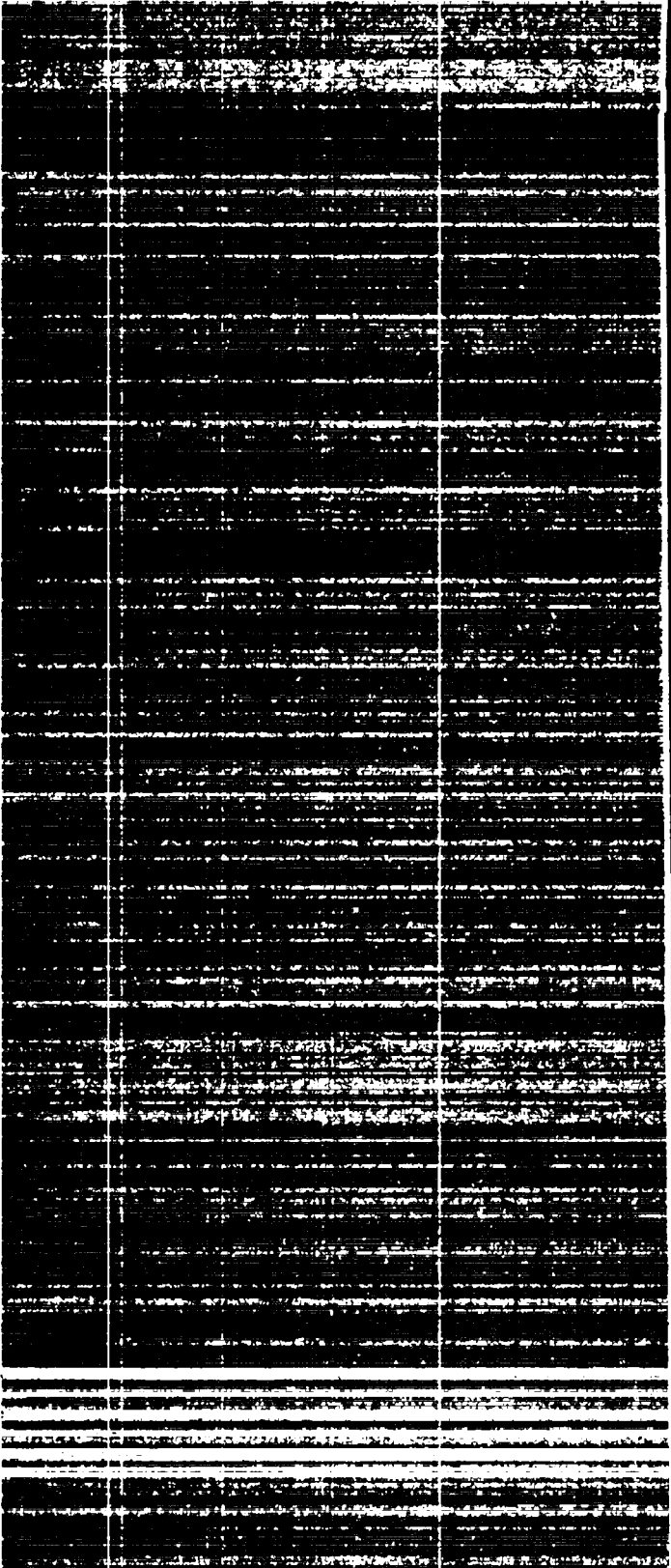
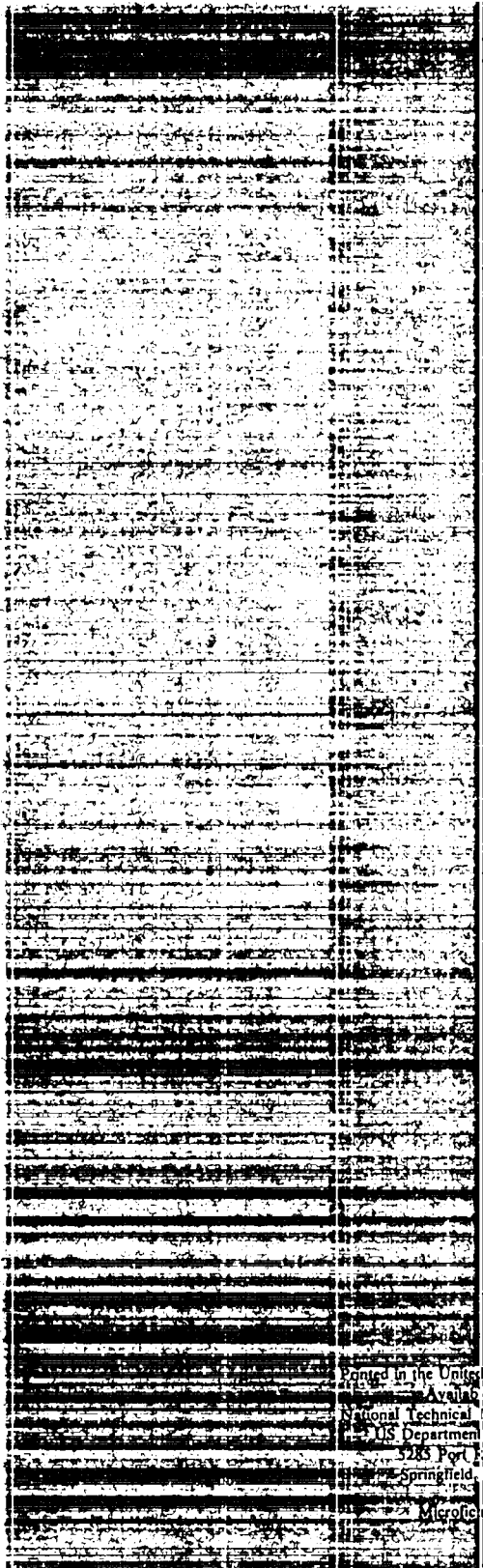

Printed in the United States of America
 Available from
 National Technical Information Service
 US Department of Commerce
 5285 Port Royal Road
 Springfield, VA 22161
 Microfilm (A01)

NTIS		NTIS	
Page Range	Price Code	Page Range	Price Code
001-025	A02	151-175	A08
026-050	A03	176-200	A09
051-075	A04	201-225	A10
076-100	A05	226-250	A11
101-125	A06	251-275	A12
126-150	A07	276-300	A13

NTIS		NTIS	
Page Range	Price Code	Page Range	Price Code
301-325	A14	331-375	A20
326-350	A15	376-500	A21
351-375	A16	501-525	A22
376-400	A17	526-550	A23
401-425	A18	551-575	A24
426-450	A19	576-600	A25
		601 up	A99

Contact NTIS for a price quote.