

*Evaluation of Ferrocyanide/Nitrate
Explosive Hazard*

Howard H. Cady

*Intercontractor Memorandum Purchase Order No. 095388-A-F1 Between
Battelle Pacific Northwest Laboratory and Los Alamos National Laboratory*



CONTENTS

| | |
|---|----|
| Abstract | 1 |
| Introduction | 1 |
| Executive Summary | 1 |
| Purpose of the Experiments | 2 |
| Test Results and Assessments | 3 |
| 1. Impact Sensitivity | 4 |
| 2. Friction Sensitivity | 9 |
| 3. Spark Sensitivity | 11 |
| 4. Preliminary Thermal Properties | 14 |
| a. Differential Thermal Analysis (DTA) .. | 15 |
| b. Vacuum Thermal Stability (VTS) | 27 |
| c. Henkin Critical Temperature | 33 |
| d. Accelerating Rate Calorimetry (ARC) .. | 38 |
| Appendix - Ferrocyanide DTA Curves | 46 |

FIGURES

| | | |
|----|---|----|
| 1 | Drop-weight impact machine | 5 |
| 2 | Type 12 tools | 6 |
| 3 | Configuration of the sample, porcelain peg, and plate in a BAM friction tester | 10 |
| 4 | Exploded view of spark-sensitivity sample holder | 12 |
| 5 | Schematic of DuPont DTA cell and thermocouples | 17 |
| 6 | DuPont macrocell DTA curves for INFARM1-REV-23... | 18 |
| 7 | DuPont macrocell DTA curves for INFARM2-REV-22 .. | 20 |
| 8 | DuPont macrocell DTA curves for UPLANT2-10 | 21 |
| 9 | DuPont micro-cell DTA curves for INFARM1-REV-23 as a function of heating rate | 22 |
| 10 | Dry ferrocyanides 20°C-480°C at 10°C/min | 23 |
| 11 | Dry ferrocyanides 260°C-380°C at 10°C/min | 24 |
| 12 | Dry ferrocyanides 20°C-480°C at 5°C/min | 25 |
| 13 | Dry ferrocyanides 260°C-380°C at 5°C/min | 26 |
| 14 | VTS manometer tube and cell | 28 |
| 15 | First run of VTS to show gas evolution from INFARM1-REV-23 at 160°C. | 30 |
| 16 | Second run of VTS to show gas evolution from INFARM1-REV-23 at 160°C. | 31 |
| 17 | Henkin critical-temperature metal-bath assembly . | 35 |
| 18 | Time-to-explosion data for RDX-based EXTEX | 36 |
| 19 | Time-to-explosion data for dried INFARM1-REV-23 . | 37 |
| 20 | ARC internal logic schematic | 40 |
| 21 | Typical ARC step run with exothermic reaction | 41 |

FIGURES (Continued)

22 ARC calorimeter package and sample cell 42

APPENDIX FIGURES

20°C to 480°C Temperature Range

A-1 INFARM1-REV-23, dry, macro, 5°C/min 47
A-2 INFARM1-REV-23, wet, macro, 5°C/min 48
A-3 INFARM1-REV-23, wet, macro, 5°C/min 49
A-4 INFARM2-REV-22, dry, macro, 5°C/min 50
A-5 INFARM2-REV-22, wet, macro, 5°C/min 51
A-6 INFARM2-REV-22, wet, macro, 5°C/min 52
A-7 UPLANT2-10, dry, macro, 5°C/min 53
A-8 UPLANT2-10, wet, macro, 5°C/min 54
A-9 UPLANT2-10, wet, macro, 5°C/min 55
A-10 VENDOR MIX#1, as received, macro, 5°C/min 56
A-11 INFARM1-REV-23, dry, micro, 20°C/min 57
A-12 INFARM1-REV-23, dry, micro, 10°C/min 58
A-13 INFARM1-REV-23, dry, micro, 5°C/min 59
A-14 INFARM1-REV-23, dry, micro, 2°C/min 60
A-15 INFARM2-REV-22, dry, micro, 10°C/min 61
A-16 INFARM2-REV-22, dry, micro, 5°C/min 62
A-17 UPLANT2-10, dry, micro, 10°C/min 63
A-18 UPLANT2-10, dry, micro, 5°C/min 64
A-19 VENDOR MIX#1, as received, micro, 10°C/min 65
A-20 VENDOR MIX#1, as received, micro, 5°C/min 66

APPENDIX FIGURES (Continued)

300°C to 415°C Temperature Range

| | | |
|------|---|----|
| A-21 | INFARM1-REV-23, dry, micro, 20°C/min | 67 |
| A-22 | INFARM1-REV-23, dry, micro, 10°C/min | 68 |
| A-23 | INFARM1-REV-23, dry, micro, 5°C/min | 69 |
| A-24 | INFARM1-REV-23, dry, micro, 2°C/min | 70 |
| A-25 | INFARM2-REV-22, dry, micro, 10°C/min | 71 |
| A-26 | INFARM2-REV-22, dry, micro, 5°C/min | 72 |
| A-27 | UPLANT2-10, dry, micro, 10°C/min | 73 |
| A-28 | UPLANT2-10, dry, micro, 5°C/min | 74 |
| A-29 | VENDOR MIX#1, as received, micro, 10°C/min | 75 |
| A-30 | VENDOR MIX#1, as received, micro, 5°C/min | 76 |

TABLES

| | | |
|---|--|----|
| 1 | Results of the Impact-Sensitivity Test | 8 |
| 2 | Results of the Friction-Sensitivity Test | 10 |
| 3 | Results of the Spark-Sensitivity (3-mil Foil) Test | 13 |
| 4 | Results of the Spark-Sensitivity (10-mil Foil) Test | 14 |
| 5 | Mass Spectral Analysis of VTS Gas for INFARM1- REV-23 Heated at 160°C for 120 h | 32 |
| 6 | Water-Corrected Mass Spectral Analysis of VTS Gas for INFARM1-REV-23 Heated at 160°C for 120 h | 32 |
| 7 | Henkin Critical Temperature | 36 |

**PROJECT REPORT:
EVALUATION OF FERROCYANIDE/NITRATE EXPLOSIVE HAZARD**

Intercontractor Memorandum Purchase Order No. 095388-A-F1
Between Pacific Northwest Laboratory
and
Los Alamos National Laboratory
Prepared by: Howard H. Cady

Abstract

Small-scale high-explosive safety tests were performed to assess the explosive hazard of several simulated waste-tank ferrocyanide sludges for Pacific Northwest Laboratory. These tests show that these materials are not initiated by mechanical insult, and they require an external heat source before any exothermic chemical reaction can be observed.

Introduction

Los Alamos National Laboratory (LANL) agreed to assist Pacific Northwest Laboratory (PNL) in the Ferrocyanide Safety Evaluation Program by helping to evaluate the explosive hazard of several mixtures of simulated ferrocyanide sludge containing sodium nitrate and sodium nitrite (INFARM1-REV-23, INFARM2-REV-22, UPLANT2-10, and VENDOR MIX#1). This report is an evaluation of the small-scale safety tests that LANL used to assess the safety of these materials from an explosive materials point of view. A series of laboratory tests is normally performed by LANL to evaluate handling hazards and determine ease of initiation of chemical reaction by impact, friction, electrical spark, and heat. The mixtures tested by many of these standard LANL tests were prepared by Westinghouse Hanford Corporation (WHC). The INFARM1-REV-23, INFARM2-REV-22, and UPLANT2-10 materials were sent to LANL as wet sludges, while the VENDOR MIX#1 was supplied as a dry powder. Aliquots of the wet samples were freeze dried at LANL to prepare dry mixes for testing.

Executive Summary

The INFARM1-REV-23, INFARM2-REV-22, UPLANT2-10, and VENDOR MIX#1 mixtures were tested at LANL. They proved safe to handle in either their wet, as received, or dried forms from an explosives point of view. The three wet mixes and four dried mixes showed no evidence for ignition under the most severe impact conditions available at either ambient temperatures or when heated to maintain a 60°C sample temperature. None of the mixtures showed any evidence of ignition in LANL's friction test under the most severe conditions available at LANL. The test could not be repeated at 60°C because the manufacturer of the testing machine would not certify it for operation at 60°C. Apparent reactions

were observed for all materials in the spark-sensitivity test at energies much higher than are required to ignite all but the most insensitive explosives. These reactions were the result of thermal decomposition caused by electric arc heating. Even the wet UPLANT2-10 sample indicated a "reaction" that must be caused by the steam generated by the rapid boiling of water in the sample. Differential thermal analysis (DTA) curves were obtained on all seven materials as a function of heating rate and sample diameter. These tests show that these materials, when dry (except for UPLANT2-10), are more reactive than the FECN-1 sample tested in FY90. The materials tested this year decompose autocatalytically in DTA tests at temperatures above 290°C. The temperature for rapid decomposition falls as the heating rate is decreased.

A break in thermal decomposition mechanism will occur at the eutectic melting point of the oxidizer salts. The DTA curves showed endotherms at temperatures of 220°C and 280°C, where substantial changes in rates of chemical reaction are likely. Prediction of a thermal hazard at temperatures below these endotherms that is based on higher temperature data is not technically sound and will indicate a hazard when one does not, in fact, exist. We were able to detect an exothermic reaction at all temperatures above 220°C in our accelerating rate calorimeter (ARCTM)¹ test. The 160°C vacuum-thermal-stability (VTS) test results are unusual and perhaps should be confirmed. The gaseous products imply a slow, non-exothermic chemical reaction at 160°C in the INFARM1-REV-23 sample.

The preliminary small-scale tests conducted at LANL indicated that purely mechanical insult to these ferrocyanide mixtures should not cause any chemical reaction that could grow to an explosion.

Purpose of the Experiments

The purpose of the experiments conducted for this report is to learn enough about the explosive sensitivity properties of wet and dry INFARM1-REV-23, INFARM2-REV-22, UPLANT2-10, and VENDOR MIX#1 (received dry) so that they could be placed in hazard classes relative to other known energetic materials.

The sensitivity of an explosive material is not a well-defined property of the material, expressible as a single number, but instead is a complex pattern of behavior. In the present context, the sensitivity of an explosive refers to the probability that it will undergo a sudden partial or complete decomposition when subjected to stimulus. Different sensitivity tests, even when intended to measure the same property, will frequently pro-

¹ARC is a Trade Mark of Columbia Scientific Industries.

duce different orders of relative sensitivity for a given series of explosive materials. In other words, there is not even a unique qualitative scale of sensitivity. The sensitivity of an explosive material depends on numerous chemical, physical, and mechanical factors, some controllable, some not. In sensitivity tests, the response of an explosive varies in seemingly random fashion over some range of severity of the applied stimulus. That is, there is no sharp threshold above which the explosive will always explode, or below which it will never explode.

The response of an explosive to a stimulus may be partial, even minute, or it may be a complete, high-order detonation. Three particular sensitivity characteristics are of special importance:

1. the ease with which a detectable reaction of any sort can be produced in the material,
2. the tendency of any small reaction, once started, to grow to destructive proportions, and
3. the ease with which a high-order detonation can be established in the material.

The second sensitivity characteristic cannot be completely separated from the first, but one can obtain a "feel" for this tendency from the variation in magnitude of response to identical stimuli. Our small-scale tests of wet and dry INFARM1-REV-23, INFARM2-REV-22, UPLANT2-10, and dry VENDOR MIX#1 did not indicate any unusual tendencies of small reactions to easily grow into large reactions. We did not directly address the third item in our tests of these materials. Only primary explosives detonate in the small-scale tests we used, and none of these materials is a primary explosive.

At LANL, we require a determination of impact, friction, spark, and thermal sensitivities before we feel confident to place a new energetic material in a handling-hazard classification. In effect, these tests rank the material by a combination of the first and second characteristics for several types of stimulus common in accidents.

Test Results and Assessments

Results from tests that measure the sensitivity of explosives vary significantly when samples contain liquids such as oil or water. Samples of INFARM1-REV-23, INFARM2-REV-22, and UPLANT2-10 were received as wet pastes on May 20, 1992. A portion of each sample was placed in a Lancer disposable liquid transfer pipette (product #8889-010818) and sealed from further evaporation by inserting the plunger, sealing the injection tip with a Tygon stopper, and placing the assembly in a zip-lock bag. These "wet" materials were dispensed as needed by removing the stopper and applying pressure to the plunger. The "dry" versions of these

materials were prepared by transferring other aliquots of the pastes as received to watch-glasses, freezing the aliquots with liquid nitrogen, and drying the materials in a vacuum chamber held at about 7 microns Hg for six days. Under these conditions, water in the form of ice sublimates without melting, and the "soluble" salts are separated as fine crystals when the paste is frozen. The dried materials are friable and easily reduced to powders suitable for our experiments. Crude measurement of the water content of the pastes based on weight loss in freeze drying was 46% for INFARM1-REV-23, 50% for INFARM2-REV-22, and 65% for UPLANT2-10. These estimates are crude because the samples were losing weight rapidly while they were being transferred to the watch-glasses, and they were gaining weight while equilibrating with ambient air (about 20% RH) after freeze drying. The VENDOR MIX#1 sample was received as a dry powder on June 1, 1992. It was tested in an "as received" condition. None of the dry materials are deliquescent at Los Alamos, and they remain as free flowing powders after equilibration with ambient air.

1. Impact Sensitivity

(J. J. Stimmel, W. J. Fernandez, T. Rivera)

In the broadest sense, the drop-weight impact test will indicate the likelihood of an explosive producing unwanted, accidental reactions when it is subjected to the miscellaneous impacts (scrapings, pinchings, drops, etc.) incidental to research, development, manufacture, loading, and use. Or, to restate, the test should tell us how careful we must be to avoid unwanted reactions while handling the material. Unfortunately, history has shown that although the impact test is our most useful test, its results are not adequate to provide predictions of all possible handling accidents.

The drop-weight impact machine used at LANL is based on a design that the Explosives Research Laboratory at Bruceton, Pennsylvania, developed during World War II. The bulk of the machine (Figure 1) consists of a device for hoisting, releasing, and guiding the 2.5-kg free-falling weight, and a massive steel and concrete base. The most critical parts, as far as results are concerned, are the tools illustrated in Figure 2. The hardened steel anvil is firmly seated on the steel base by the anvil holder. In the Type 12 test, a 40-mg sample of the explosive under test is placed in a shallow depression in a 2.5-cm square of 5/0 garnet sandpaper, which is then placed on the anvil. The hardened-steel striker is carefully lowered through the guide ring onto the sample, and the weight is then raised to the desired height and dropped onto the striker. The Type 12B test is similar except that the striker and anvil surfaces are roughened by sandblasting with No. 120 grit SiC, and the 40-mg sample is placed directly on the roughened anvil.

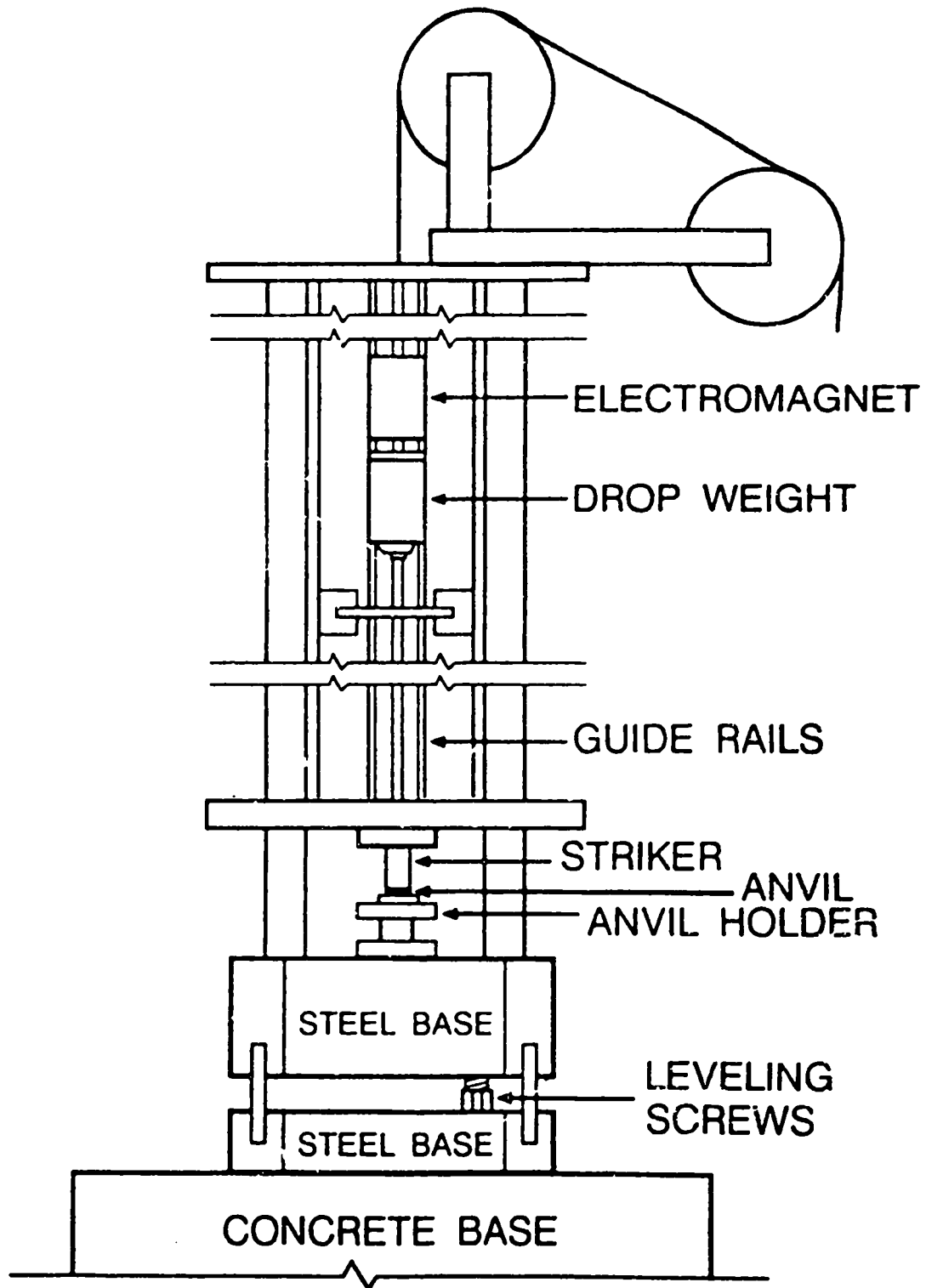

Figure 1. Drop-weight impact machine.

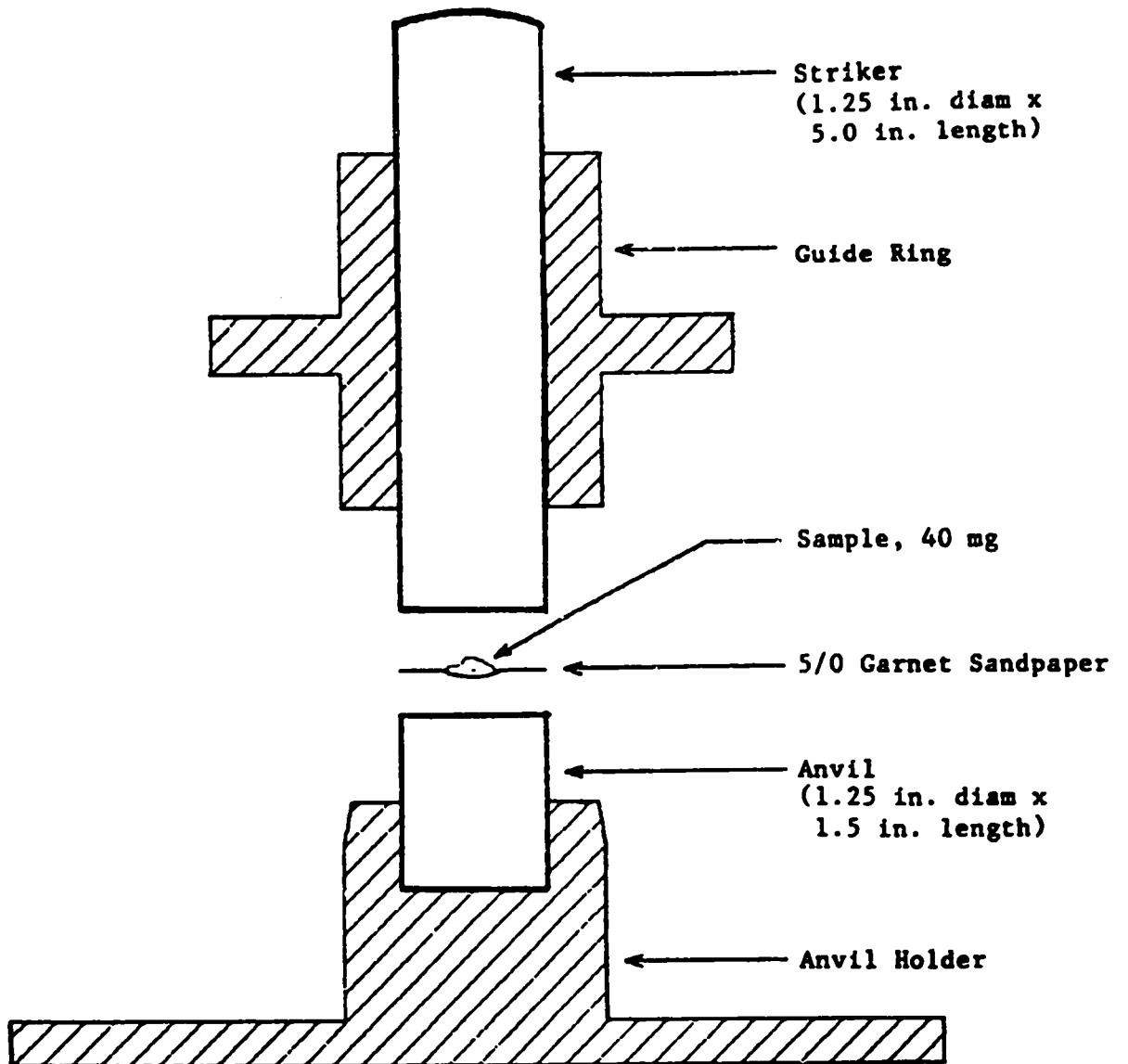

Figure 2. Type 12 tools.

The reaction of the sample may range anywhere from completely inert to a fairly violent explosion. Sensitive explosives, such as PETN (pentaerythritoltetranitrate), usually react violently or not at all, while less sensitive materials, such as TNT (2,4,6-trinitrotoluene), will produce a wide range of partial explosions. While there is a general, but variable, increase in the extent of the reaction with drop height, it is convenient to classify the results of each drop as either an E (event) or an N (no reaction).

Because small reactions are difficult to detect, and the human ear varies in sensitivity, a microphone is used to determine whether the result of a given drop is an E or an N. The sensitivity of the microphone is adjusted to produce a reading of 9 or higher on a digital meter when a standard high explosive, such as HMX (octahydro-1,3,5,7-tetranitro-1,3,5,7-tetrazocine) or RDX (hexahydro-1,3,5-trinitro-1,3,5-triazocine), receives an impact at a drop height known from experience to produce an E ("go"). Adjusted in this way, the meter at LANL reports an E when about 5% or more of the standard high-explosive sample reacts. A fresh sample is used for each drop.

A standard test consists of 25 shots performed by following the "up and down" Bruceton testing technique normally used in sensitivity testing. The results are reported in terms of the height at which an E is obtained 50% of the time (H_{50}). The interval used at LANL is to add or subtract, as appropriate, 0.05 to the logarithm (base 10) of the preceding drop height. The logarithmic scale is used on the assumption that the heights at which events occur follow a lognormal distribution. A short series of 13 drops is used when the first 13 drops are all Ns at a drop height of 320 cm. This height is the maximum drop used at LANL. In this case, H_{50} was reported as "No go at 320" or >320.

It is normal to intermix drops on a known standard material with drops on the unknown materials to ensure that the impact machine is working properly. The standard material for this study was HMX Lot HOL 41-57, the current HMX Impact Standard at LANL.

LANL has the capability to do impact testing at temperatures as high as 260°C. It was requested that the dried materials be tested at 60°C to see if there is any noticeable shift in sensitivity with temperature. The results are summarized in Table 1. Accepted values for other common explosives and TATB (1,3,5-triamino-2,4,6-trinitrobenzene), an extremely insensitive explosive, are also included.

The values measured for the HMX Standard are within normal range and indicate proper functioning of the impact machine. All of the ferrocyanide materials tested are so insensitive that they are beyond the range at which explosive materials can be ranked

by our impact sensitivity test. Materials in this range are considered quite safe to impact stimulus.

Table 1. Results of the Impact-Sensitivity Test

| <u>Test</u> | <u>Sample</u> | <u>H₅₀ (cm)</u> |
|-------------|----------------------|----------------------------|
| Type 12 | HMX HOL 41-57 | 32.3 |
| (ambient) | HMX Standard (Avg.) | 34.4±1.8 |
| " | INFARM1-REV-23 (wet) | >320 |
| " | INFARM1-REV-23 (dry) | >320 |
| " | INFARM2-REV-22 (wet) | >320 |
| " | INFARM2-REV-22 (dry) | >320 |
| " | UPLANT2-10 (wet) | >320 |
| " | UPLANT2-10 (dry) | >320 |
| " | VENDOR MIX#1 | >320 |
| " | PETN | 12-16 |
| " | RDX | 23-28 |
| " | TNT (Handbook) | 157 |
| " | TATB (Handbook) | >320 |
| (60°C) | HMX HOL 41-57 | 34.6 |
| " | INFARM1-REV-23 (wet) | >320 |
| " | INFARM1-REV-23 (dry) | >320 |
| " | INFARM2-REV-22 (wet) | >320 |
| " | INFARM2-REV-22 (dry) | >320 |
| " | UPLANT2-10 (wet) | >320 |
| " | UPLANT2-10 (dry) | >320 |
| " | VENDOR MIX#1 | >320 |
| Type 12B | HMX HOL 41-57 | 32.6 |
| (ambient) | HMX (Handbook) | 37 |
| " | INFARM1-REV-23 (wet) | >320 |
| " | INFARM1-REV-23 (dry) | >320 |
| " | INFARM2-REV-22 (wet) | >320 |
| " | INFARM2-REV-22 (dry) | >320 |
| " | UPLANT2-10 (wet) | >320 |
| " | UPLANT2-10 (dry) | >320 |
| " | VENDOR MIX#1 | >320 |
| " | PETN | 13-20 |
| " | RDX | 23-28 |
| " | TNT (Handbook) | >320 |
| " | TATB (Handbook) | >320 |
| (60°C) | HMX HOL 41-57 | 33.9 |
| " | INFARM1-REV-23 (wet) | >320 |
| " | INFARM1-REV-23 (dry) | >320 |
| " | INFARM2-REV-22 (wet) | >320 |
| " | INFARM2-REV-22 (dry) | >320 |
| " | UPLANT2-10 (wet) | >320 |
| " | UPLANT2-10 (dry) | >320 |
| " | VENDOR MIX#1 | >320 |

2. Friction Sensitivity

(G. Jio, T. Rivera)

Friction is commonly considered an important source of accidental ignition. This is especially true of high explosives such as primary explosives, the more sensitive secondary explosives, certain pyrotechnics, and large charges. Numerous attempts have been made to design small-scale friction tests for use on high explosives. Los Alamos National Laboratory has replaced its sliding-torpedo friction test with the large Bundesanstalt für Materialprüfungen (BAM) friction-testing machine manufactured by Julius Peters GmbH, Berlin, Germany, because the BAM machine obtains responses from a wider range of explosives than the older LANL design. However, it still remains the case that only the more sensitive secondary explosives yield responses during testing.

The BAM friction-testing machine consists of a friction device mounted on a cast-steel base plate. The friction device is made of a fixed porcelain peg and a moveable porcelain plate. The plate is held in a cradle that slides between two rails. The cradle is driven by a rod, an eccentric pulley, and a transmission gear with a grab clutch powered by an electric motor. The plate is moved under the peg with a backward and forward motion of 10 mm. The porcelain peg is loaded by means of a lever arm and fixed weights. The load on the peg can be varied from 0.5 to 36 kg.

The unglazed porcelain plates are composed of white technical porcelain. Both friction surfaces of the plates are coarsened before firing by rubbing with a sponge. These sponge marks are clearly visible. The cylindrical unglazed porcelain pegs are also made from white technical porcelain. They are 15 mm long, 10 mm in diameter, and have rough spherical end surfaces with a 10-mm radius of curvature. This coarseness of the plates and peg is an essential prerequisite for the reaction of the explosive material; therefore, any given section of these surfaces can be used only once.

Test substances should be dry powders with particle sizes <0.5 mm. Test results are both visual and audio. Results are categorized as "no reaction," "decomposition," (discoloration, smell), "flash or flame," "snap," or "explosion." The first two are considered Ns while the last three are Es.

To begin the test procedure, the porcelain plate is fastened to the sliding cradle so that the sponge marks are perpendicular to the direction of travel. A test sample of about 10 mm³ is then measured onto the plate. The peg is directed into contact with the sample, which lies in the peg's path of travel (Figure 3).

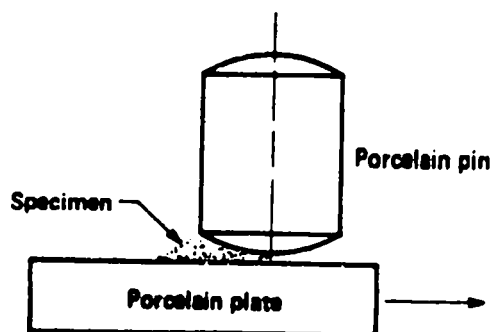

Figure 3. Configuration of the sample, porcelain peg, and plate in a BAM friction tester.

The appropriate weight is hung on the lever arm, and the clutch is activated.

The load on the rod is varied in steps of 2.4 kg in the Bruceton up-and-down test sequence, and the statistical value of Wt_{50} is reported as the sensitivity.

Table 2 summarizes the results of the friction sensitivity test for the seven ferrocyanide samples and the PETN sample that was run concurrently to ensure the machine was functioning properly. The normal values obtained for several explosives also appear in Table 2. The result for the PETN sample is well within the normal range for this material.

Table 2. Results of the Friction-Sensitivity Test

| <u>Sample</u> | <u>Wt₅₀ (kg)</u> |
|-------------------------|-----------------------------|
| INFARM1-REV-23 (wet) | >36 |
| INFARM1-REV-23 (dry) | >36 |
| INFARM2-REV-22 (wet) | >36 |
| INFARM2-REV-22 (dry) | >36 |
| UPLANT2-10 (wet) | >36 |
| UPLANT2-10 (dry) | >36 |
| VENDOR MIX#1 | >36 |
| PETN (0601-02 RPS-3518) | 8.8 |
| PETN (average value) | 9.6±1.2 |
| HMX (average value) | 13.6 |
| RDX (average value) | 17.3 |
| Comp B | >36 |
| TNT | >36 |

All of the ferrocyanide samples were insensitive enough to test outside the friction sensitivity range established to rank materials. However, it should be noted that the same can be said for many common military explosives because only the more sensitive secondary explosives react in this test. These ferrocyanide materials are all considered safe to handle according to the friction sensitivity test.

3. Spark Sensitivity

(J. J. Stimmel, W. J. Fernandez, T. Rivera)

Another small-scale safety test used at LANL is the Spark Sensitivity Test. In this test, a static electric discharge is passed through the sample. The energy level at which confining foil is ruptured is the minimum level at which an E will occur. There are two principal reasons for performing this test. First, Los Alamos has a dry climate; therefore, it is relatively easy for a human body to develop and retain a significant static charge in normal laboratory operations. Second, we have encountered several explosives that were relatively insensitive to both impact and friction, but were quite sensitive to electric discharge. If unrecognized, this could lead to extremely hazardous operations in blending or handling processes.

The spark sensitivity of a material is determined by subjecting it to a high-voltage (5000 V) discharge from a variable capacitance bank. The discharge energy is increased and decreased until the energy level is found that produces an event in 50% of the samples.

To conduct the test, material is placed in a holder like that shown in Figure 4. A polystyrene sleeve is cemented around a steel dowel leaving a 3/16-in.-diam by 1/4-in.-high space to hold the sample. The sample is placed in the sleeve space and covered with either 3-mil or 10-mil lead foil. A polystyrene clamping ring is then clamped over the sleeve to hold the foil and sample in place. The assembly is then positioned in an enclosed steel box equipped with various interlocks. A capacitor bank, which is charged to 5000 V and the desired energy level, is connected to a pin held in a spring-loaded device resembling a single-stroke sewing machine. The steel dowel provides the ground plane for the electrical circuit. When the needle is released, it is driven rapidly through the lead foil into the sample and then retracted (in about 0.04 s). At closest approach, the separation between the needle and the dowel is about 2 mm.

At some point, a discharge occurs in the sample. Four levels of reaction are typically observed: no reaction sufficient to modify the lead foil (an N), deformation of the foil without a

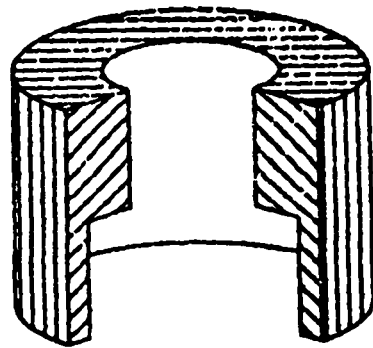

Polystyrene Clamping Ring



Confining Foil

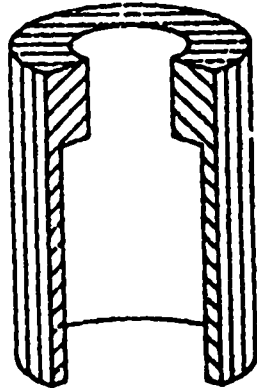

Polystyrene Sleeve

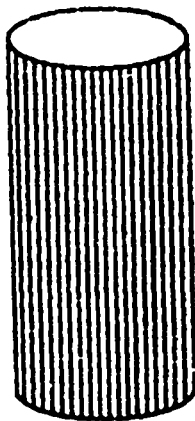

Steel Dowel

Figure 4. Exploded view of spark-sensitivity sample holder.

rupture (an N), rupture of the foil (a Go), or destruction of the polystyrene holder (an explosion). Energies are calculated using the equation $E = 1/2CV^2$, where E = spark energy in joules, C = capacitance in farads, and V = potential in volts. The 50 percentage points required to categorize test results as a Go/Explosion (in energy) are determined by using the Bruceton up-and-down method.

The normal up-and-down method was used for the 3-mil foil test for the seven ferrocyanide materials. The 50% level determined for these materials was usually lower than that for the insensitive explosive TATB, but substantially higher than that of other common explosives. The 50% point in the 10-mil foil test was at a very high energy level and some samples lie in the range between 20 and 26 J, where we do not have the capability to properly determine a statistical 50% Go value.

An HMX standard was run concurrently with the ferrocyanide samples to ensure that the spark testing machine was working properly. The results for the Spark Sensitivity Tests are summarized in Tables 3 and 4. (Note: the maximum static charge likely to be accumulated on a human body is 0.015 J.)

Table 3. Results of the Spark-Sensitivity (3-mil Foil) Test

| <u>Sample</u> | <u>Mean Energy (J)</u> |
|----------------------|------------------------|
| INFARM1-REV-23 (dry) | 1.85 |
| INFARM2-REV-22 (dry) | 1.76 |
| UPLANT2-10 (dry) | 4.8 |
| VENDOR MIX#1 | 7.5 |
| INFARM1-REV-23 (wet) | 3.8 |
| INFARM2-REV-22 (wet) | 3.8 |
| UPLANT2-10 (wet) | 4.75 |
| HMX Standard | 0.24 |
| Handbook Value PETN | 0.19 |
| Handbook Value RDX | 0.21 |
| Handbook Value HMX | 0.23 |
| Handbook Value TNT | 0.46 |
| Handbook Value TATB | 4.25 |

Table 4. Results of the Spark-Sensitivity (10-mil Foil) Test

| <u>Sample</u> | <u>Mean Energy (J)</u> |
|----------------------|------------------------|
| INFARM1-REV-23 (dry) | 19<test<26 |
| INFARM2-REV-22 (dry) | 19<test<26 |
| UPLANT2-10 (dry) | 40.4 |
| VENDOR MIX#1 | 17.6 |
| INFARM1-REV-23 (wet) | 10.0 |
| INFARM2-REV-22 (wet) | 9.6 |
| UPLANT2-10 (wet) | 11.5 |
| HMX Standard | 1.7 |
| Handbook Value PETN | 0.75 |
| Handbook Value RDX | 0.96 |
| Handbook Value HMX | 1.42 |
| Handbook Value TNT | 3.75 |
| Handbook Value TATB | 18.1 |

Steam explosions sufficient to rupture foils are apparently generated in the wet ferrocyanide samples at about 4 J in the 3-mil test and 10 J in the 10-mil test. The UPLANT2-10 (dry) material appears more stable than the UPLANT2-10 (wet), but this only means it does not generate gaseous products when heated dry.

4. Preliminary Thermal Properties

The thermal properties of explosives are important considerations in normal processing evaluations and accident investigations. Los Alamos routinely uses Vacuum Stability Tests to evaluate compatibility and heating safety for drying, hot pressing, and desert storage operations. DTA is used to look for exothermic and endothermic changes that determine the temperatures of phase changes and chemical reactions. Pyrolysis tests are run to ascertain the temperatures of the reactions that release gaseous products. Samples are small and lightly confined to limit the size of explosions and avoid significant damage. Explosions in any of these tests are considered indications of higher than desirable hazard in thermal environments. The test results indicate chemical reactions that rapidly accelerate with increasing pressure, and further indicate the types of behaviors that are necessary for deflagration-to-detonation transitions. For this project, Los Alamos was requested to determine the behavior of all seven ferrocyanide materials in the DTA test, but restrict investigations of the vacuum stability to the INFARM1-REV-23 (dry) material at the special elevated temperature of 160°C.

The Henkin critical-temperature test is a semi-routine test used to confirm the decomposition kinetic rate parameters determined from differential scanning calorimetry (DSC) measurements. The

Henkin test is useful for a preliminary estimate of scale-up effects even when kinetic parameters are not available. The Henkin sample is larger than the DTA sample, and differences in cook-off temperature are an indication of the direction and magnitude of changes that might occur with even larger samples. The Henkin test is sometimes called the time-to-explosion test because events often do not occur until several minutes after the sample is placed in a hot bath. The reason for the delay is that there are often induction processes that must occur before the start of the exothermic reactions that cause the event. Rapid gas evolution that moves a gas check or that bursts an aluminum tube is required for an event. Los Alamos was requested to measure the Henkin critical temperature of the INFARM1-REV-23 (dry) material for this project.

Los Alamos also has an ARC that is used for nonroutine research on explosives. It is the most sensitive instrument available at Los Alamos for detecting initial exothermic reactions, and it provides information of special utility for predicting temperatures at which thermal runaway will occur in large samples. Los Alamos was requested to study the behavior of the INFARM1-REV-23 (dry) material and try to determine the temperature of initial exothermic reaction.

a. Differential Thermal Analysis (DTA)
(H. H. Cady)

In DTA, a sample and an inert reference are heated at a known rate in a controlled environment. The increases in sample and reference temperatures will be about the same (depending somewhat on specific heat and thermal conductivity differences), unless a heat-related change takes place in the sample. If such change takes place, the sample temperature either leads (evolves heat) or lags (absorbs heat) the reference temperature. A DTA curve is a plot of the lead or lag as a function of sample temperature.

Two types of DTA machines are used to study explosives at LANL. One is a DuPont 1090 Thermal Analyzer. It is primarily used for research and is equipped with a 910 cell base and a standard-temperature DTA cell. The other DTA was designed at LANL and has been used for about 30 years for routine DTA work. The DuPont 1090 was used for this project. Ammonium nitrate and deionized water samples were tested to ensure that the instrument was running properly.

The DuPont standard-temperature DTA cell was used with both macro- and micro-tube silver heating blocks because this apparatus survives explosions much better than the other available DSC and DTA cells. The apparatus was operated in the programmed heating-rate mode with sample configuration and equipment settings as recommended by DuPont for their Model 910 cell base and

standard-temperature DTA cell. The DTA cell is basically a silver block with a central rod heater. A control thermocouple, used to maintain the programmed heating rate, is located near the heater. Slightly farther from the heater at identical radii are two sample-tube wells. The first well holds a glass capillary (macro-3.8-mm OD, 3.0-mm ID, flat bottomed; or micro-<2-mm OD, 1.5-mm ID) that contains an inert glass-bead sample with its embedded chromel-alumel thermocouple. The other well holds a similar capillary containing the test sample and its thermocouple. The reference and sample thermocouples are both made from a common lot of thermocouple wire. In operation, the temperature at the center of the test sample is recorded as the x-axis, and the temperature difference between the test sample and the glass bead sample is recorded as the y-axis. So many factors influence the magnitude of the difference signal that we rarely use it for any quantitative estimates of heat-of-reaction. On the other hand, the temperatures of deviation from the base line and peak shapes as a function of heating rate do provide useful information. A schematic of the DuPont DTA cell is shown in Figure 5.

The DuPont 1090 Thermal Analyzer is equipped with a microprocessor, analog-to-digital converters, magnetic disk drive, and plotter. Data from a heating experiment are recorded and plotted as the DTA is run. The plot made in real time is seldom optimal, so the recorded data are usually replotted. Many of these replotted DTA curves are included in the Appendix to this report. Several DTA runs can be combined onto a single plot to aid in the visualization of differences between runs.

Figure 6 is a combined plot showing the macrocell DTA curves for INFARM1-REV-23. The upper curve shows the behavior of the dried material through the initial stage of the major exotherm. The dashed curve shows a corresponding curve for the material in its "as received" (wet) condition, and the lower curve shows the behavior of deionized water under the same running conditions. Points to note are: (1) the dried material contains no detectable solution phase (no 100°C endotherm), (2) there is a boiling point elevation of water in the as-received material caused by solution of water-soluble salts, the boiling temperature range is extended relative to pure water, there is an extended endothermic region from about 120°C to 200°C, and (3) the final exotherm begins at about the same temperature in both the wet and dried materials. INFARM1-REV-23 is more reactive than VENDOR MIX#1 or the FECN-1 run in FY90 as evidenced by the ejection of the thermocouple during the run-up of the first exotherm. The thermocouple was ejected without evidence of an explosion, but this does not imply that there could not be an explosion, if a larger quantity of material was heated.

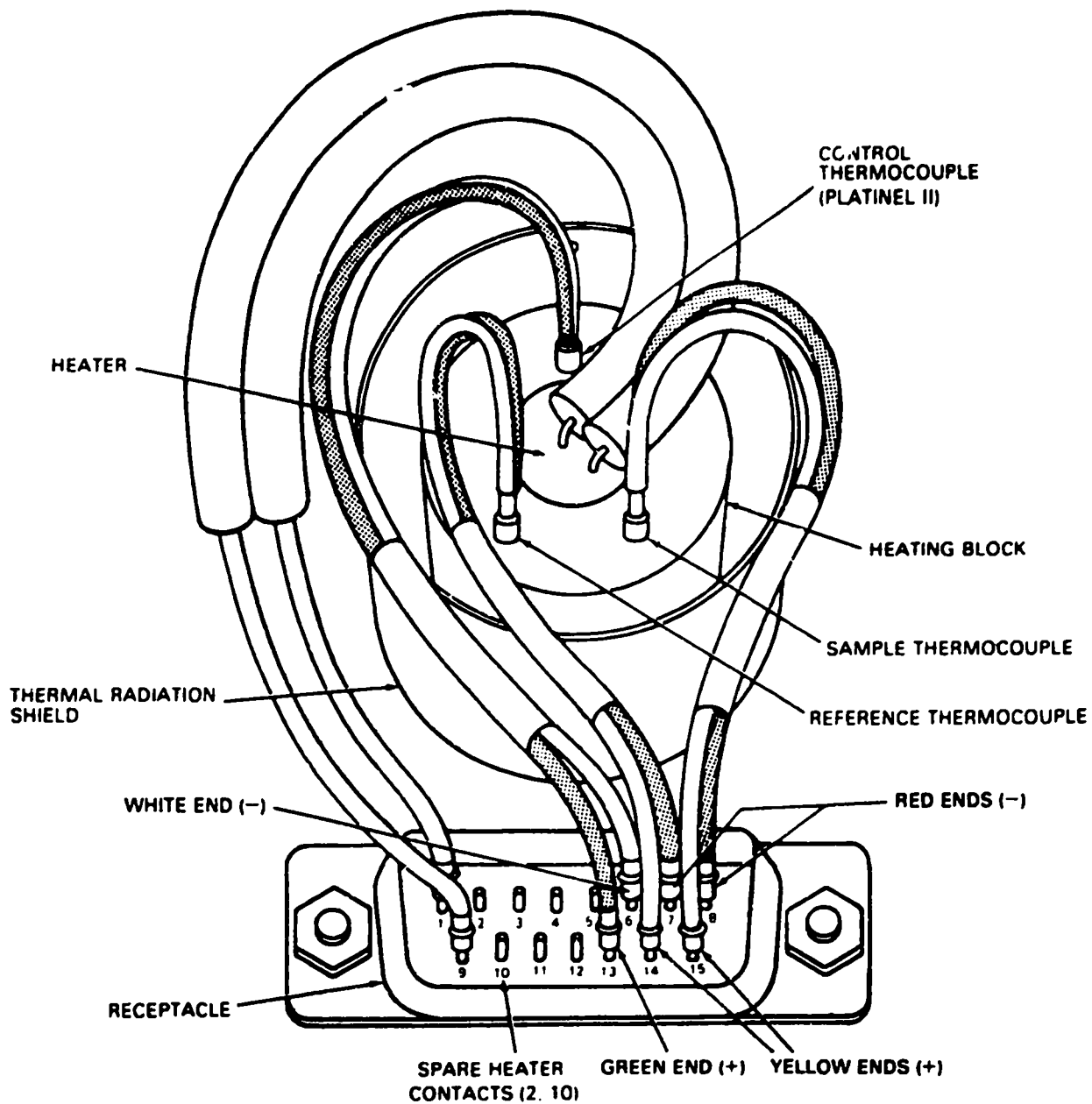

Figure 5. Schematic of DuPont DTA cell and thermocouples.

Sample: INFARM1-REV-23
Size: MACRO
Rate: 5 DEG C/MIN
Program: Extended Playback V2.0

DTA

Date: 4-Jun-92 Time: 15:07:08
File: DTA.36 DTA22
Operator: H. H. CADY
Plotted: 11-Sep-92 14:59:27

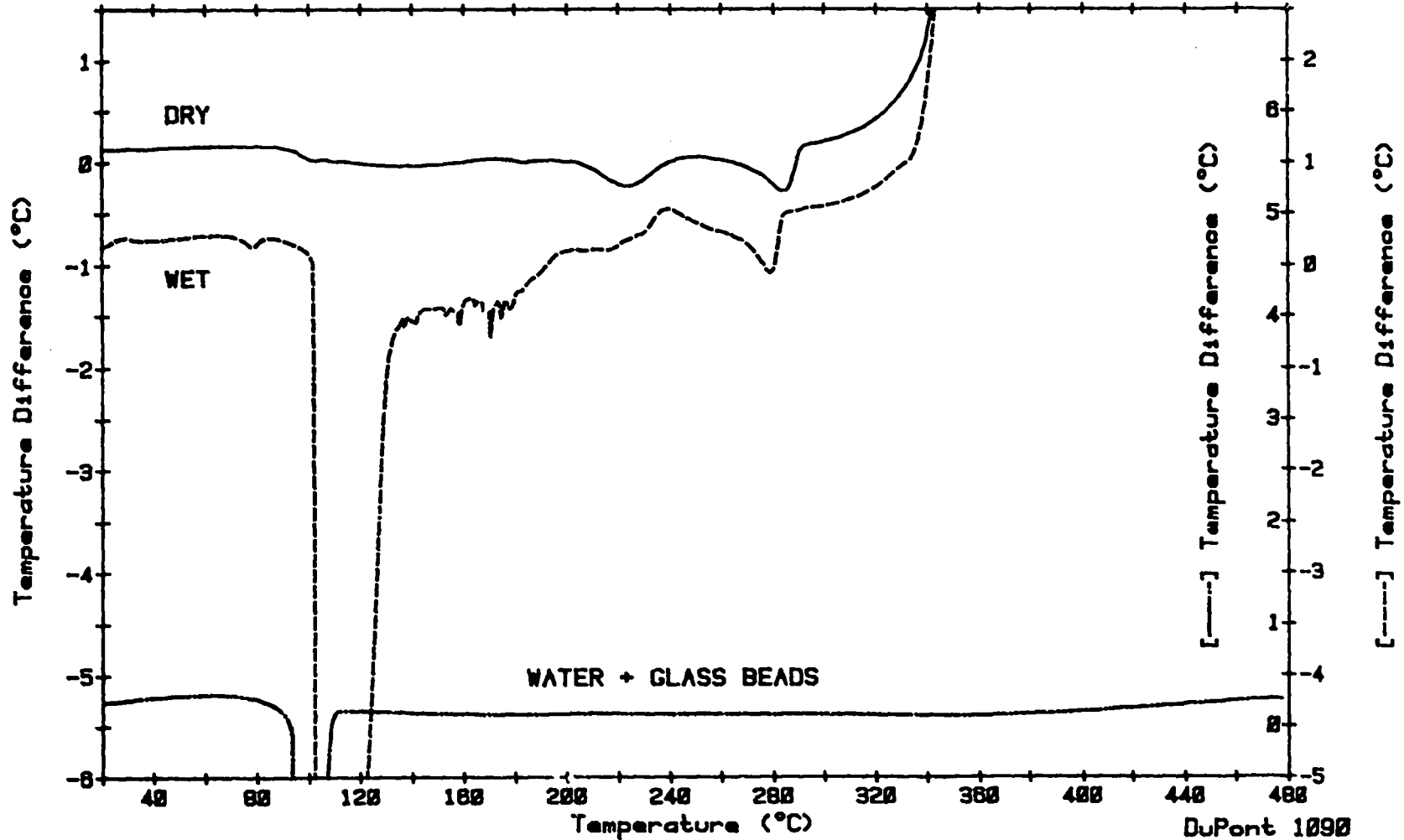

Figure 6. DuPont macrocell DTA curves for INFARM1-REV-23.

Figure 7 is a similar plot for the INFARM2-REV-22 samples. The upper "dried" curve is from a sample that had equilibrated with ambient humidity air (about 25%RH) for several days. The endotherm at about 100°C is slightly more pronounced, but there is still no indication for an aqueous solution phase. In both the wet and dry samples the sequence of endotherms before the onset of a final exotherm is similar, but not identical to that for INFARM1-REV-23. The final exotherm shows a shorter induction time than that for INFARM1-REV-23. The INFARM2-REV-22 material is somewhat more vigorously reactive than INFARM1-REV-23. Again, there were no explosions during our DTA testing even though thermocouples were ejected from their glass tubes.

Figure 8 shows the curves for UPLANT2-10. The reactions in the first exotherm are not vigorous enough to move the thermocouple. The absence of an endotherm between 120°C and 200°C may imply that this broad endotherm in wet INFARM materials is associated with the exothermic reaction above 300°C.

Figure 9 shows the high temperature microcell behavior of dried INFARM1-REV-23 as a function of heating rate. These curves very clearly illustrate the autocatalytic clock-reaction behavior of the onset of the final exotherm. Comparison of the curves of Figure 6 with the 5°C/minute curve of Figure 9 shows that the onset temperature of the exotherm is not sample size dependent in these geometries because it starts at the same temperature in both runs. Note, the position of the lower temperature endotherm (<240°C) is heating rate dependent, while the endotherm at about 280°C is unchanged in position.

Figures 10, 11, 12, and 13 show the DTA curves for all four of the dried ferrocyanide samples studied for this report at two different heating rates. Exotherm positions for all four materials are similar in position, if not vigor, and all four materials show the same autocatalytic clock-reaction and heating rate dependence. If the endotherm at about 280°C is caused by the eutectic melting of the oxidizer salts, then the reaction mechanism for the reaction with ferrocyanide should change at that temperature. The shapes of the DTA curves are quite complex and imply that it will be difficult to determine the reaction mechanism for the reaction above 280°C. The existence of a eutectic melting of the oxidizer phase also implies that any reaction mechanism determined at temperatures above the eutectic temperature cannot apply to reactions at temperatures below the eutectic temperature.

Sample: INFARM2-22

Size: MACRO

Rate: 5 DEG C/MIN

Program: Extended Playback V2.0

DTA

Date: 2-Jun-92 Time: 13:44:21

File: DTA.34 DTA22

Operator: H. H. CADY

Plotted: 11-Sep-92 15:43:12

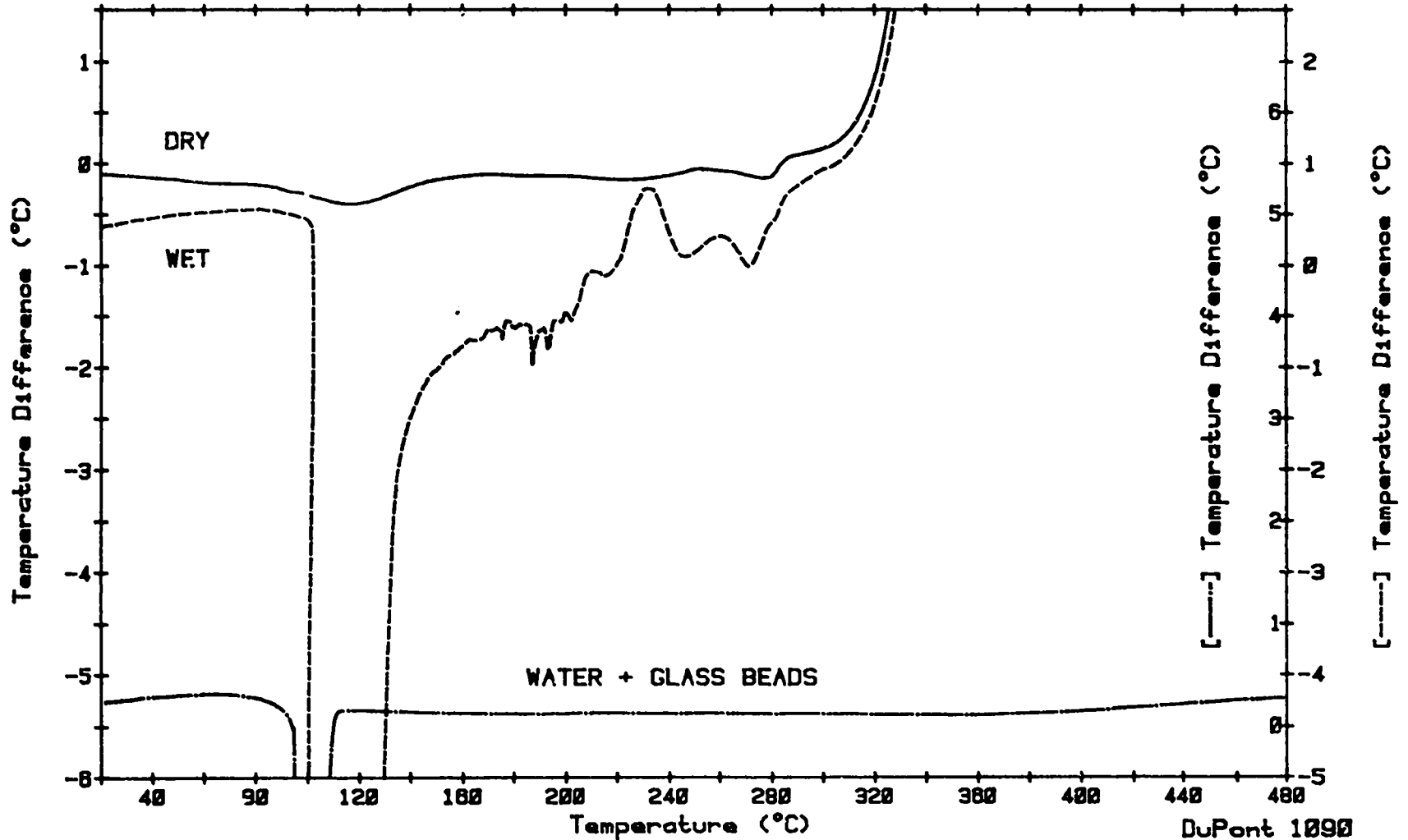
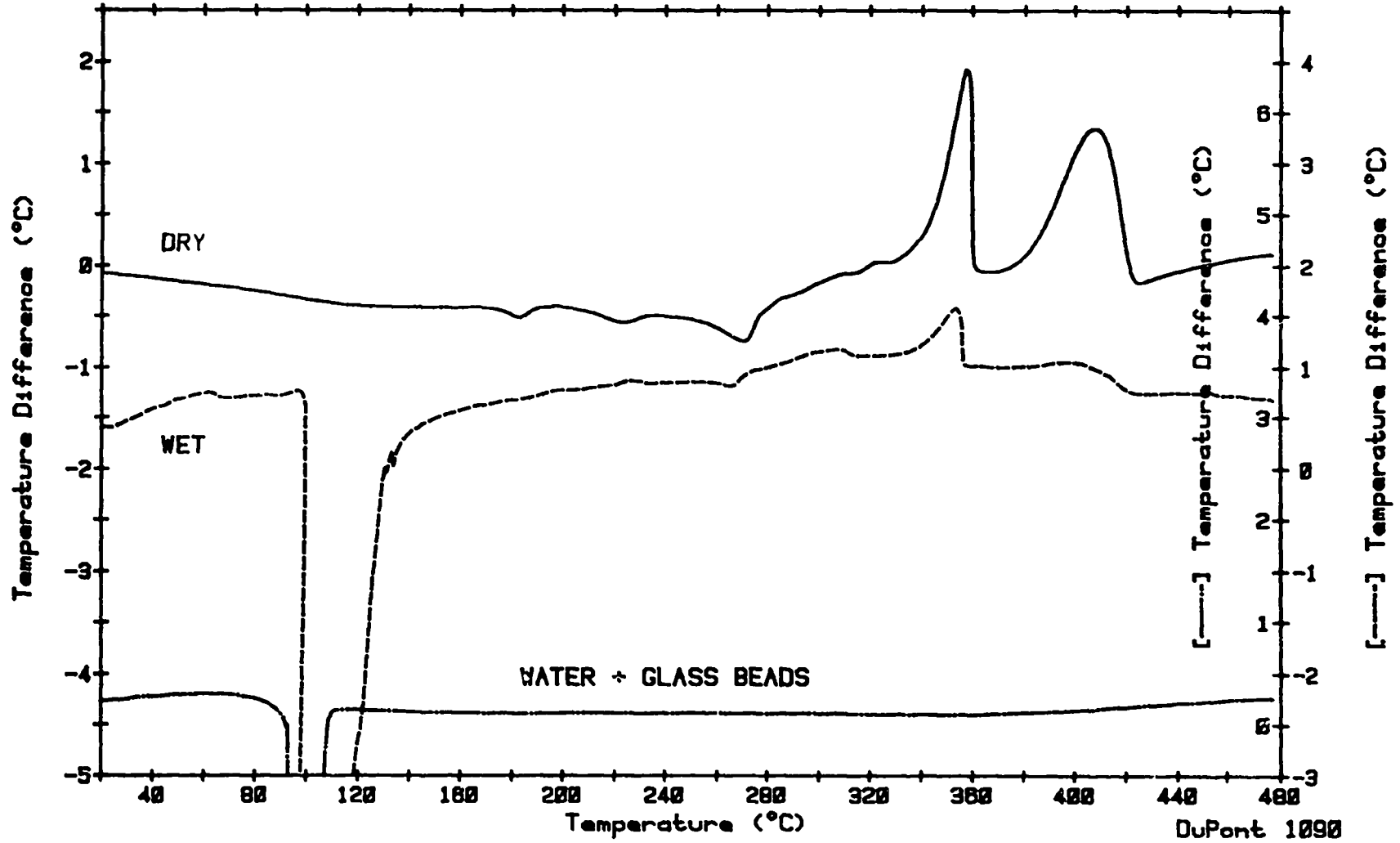

Figure 7. DuPont macrocell DTA curves for INFARM2-REV-22.

Sample: UPLANT2-10
Size: MACRO
Rate: 5 DEG C/MIN
Program: Extended Playback V2.0

DTA

Date: 8-Jun-92 Time: 12:16:36
File: DTA.37 DTA23
Operator: H.H.CADY
Plotted: 11-Sep-92 16:21:40



21

Figure 8. DuPont macrocell DTA curves for UPLANT2-10

Sampler: INFARM1-REV-23 DRY
Size: MICRO
Rate: 2/5/10/20 DEG C/MIN
Program: Extended Playback V2.0

DTA

Date: 16-Jun-92 Time: 14:40:19
File: DTA.09 DTA26
Operator: H.H.CADY
Plotted: 23-Jun-92 13:19:01

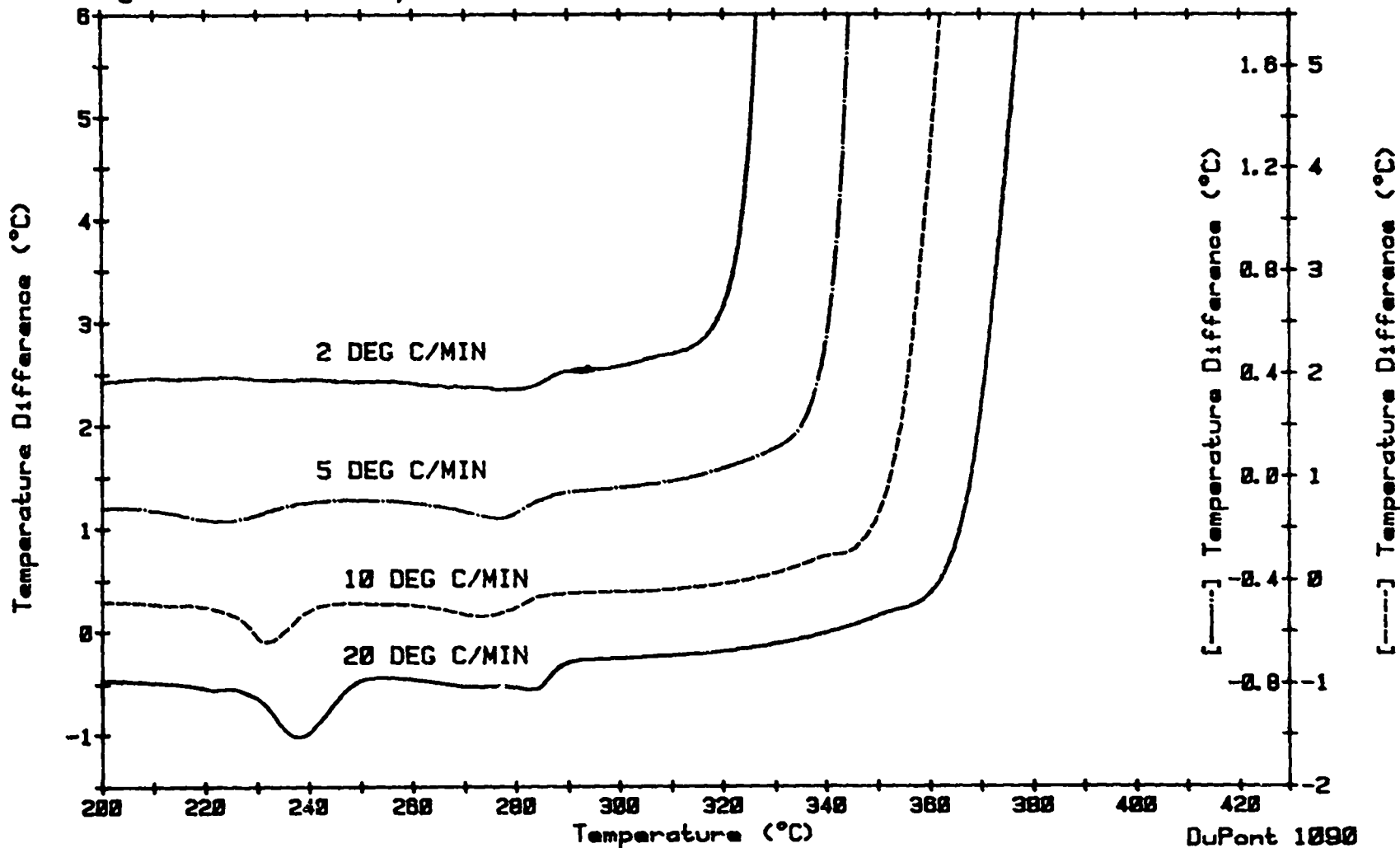

Figure 9. DuPont micro-cell DTA curves for INFARM1-REV-23 as a function of heating rate.

Sample: FERROCYANIDES DRY
Size: MICRO
Rate: 10 DEG C/MIN
Program: Extended Playback V2.0

DTA

Date: 12-Jun-92 Time: 13:33:48
File:
Operator: H. H. CADY
Plotted: 27-Sep-92 15:18:54

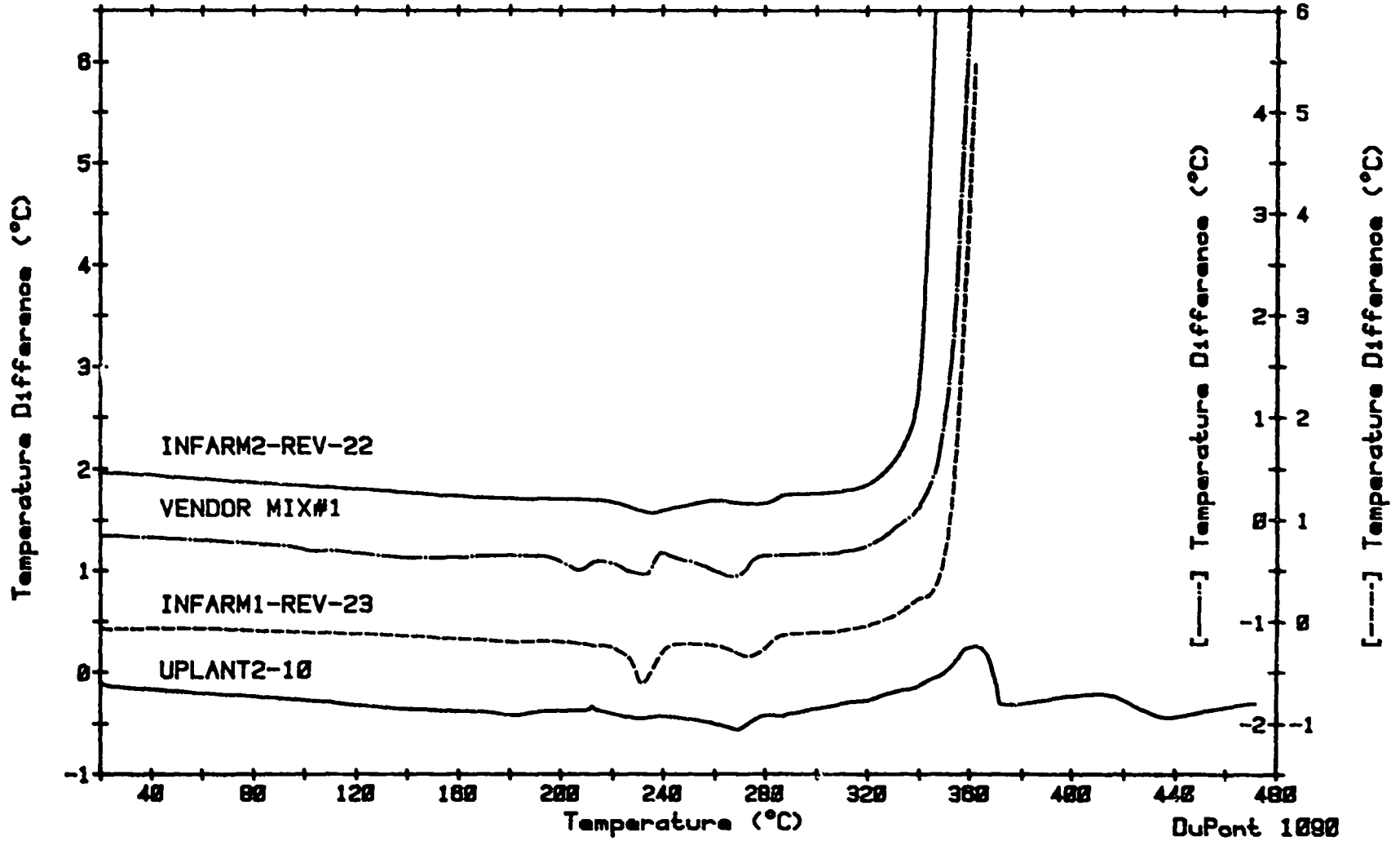

Figure 10. Dry ferrocyanides 20°C-480°C at 10°C/min.

Sample: FERROCYANIDES DRY
Size: MICRO
Rate: 5 DEG C/MIN
Program: Extended Playback V2.0

DTA

Date: 9-Jun-92 Time: 15:12:26
File:
Operator: H. H. CADY
Plotted: 27-Sep-92 16:19:44

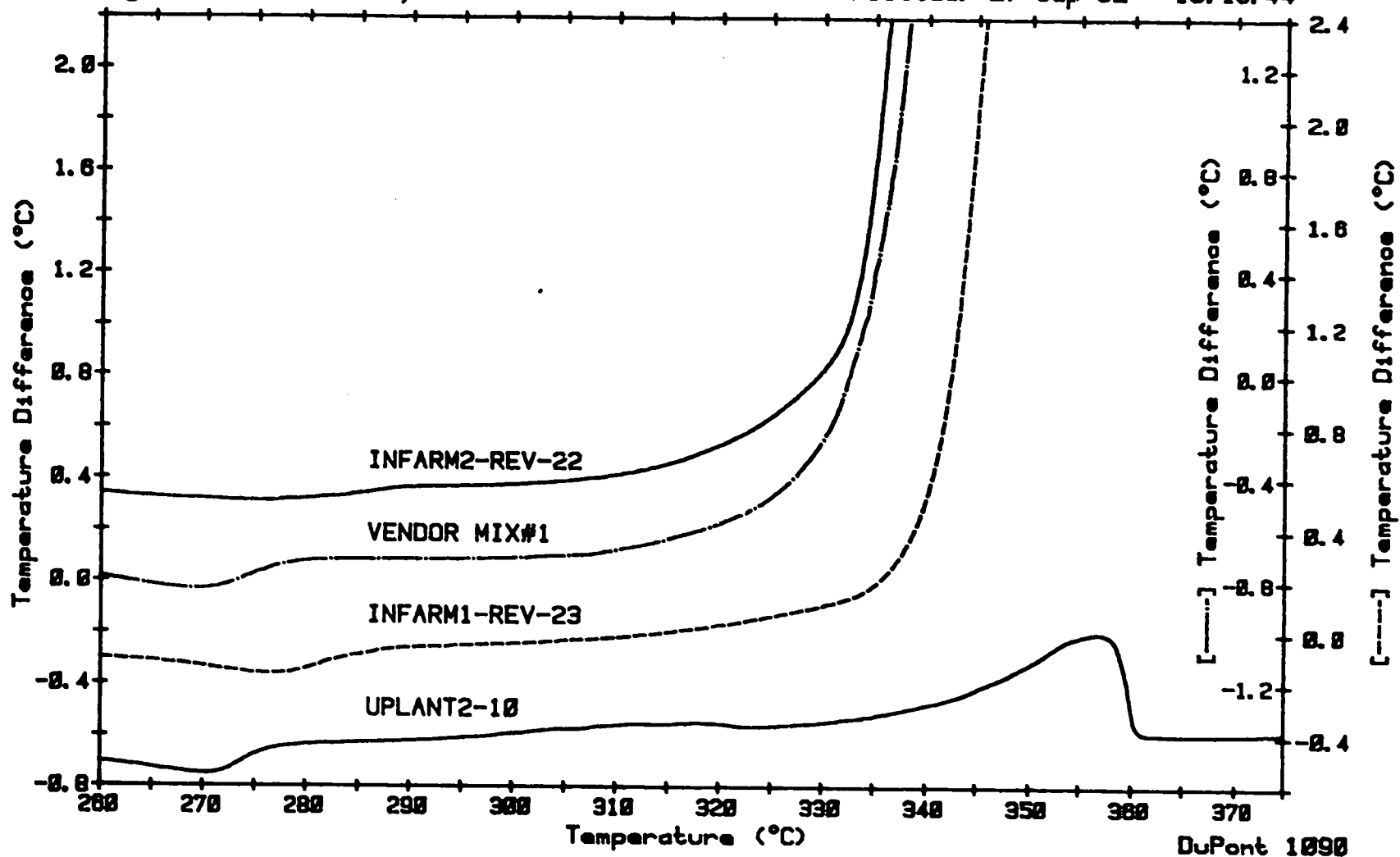

Figure 11. Dry ferrocyanides 260°C-380°C at 10°C/min.

Sample: FERROCYANIDES DRY
Size: MICRO
Rate: 5 DEG C/MIN
Program: Extended Playback V2.0

DTA

Date: 9-Jun-92 Time: 15:12:26
File:
Operator: H.H. CADY
Plotted: 27-Sep-92 16:54:27

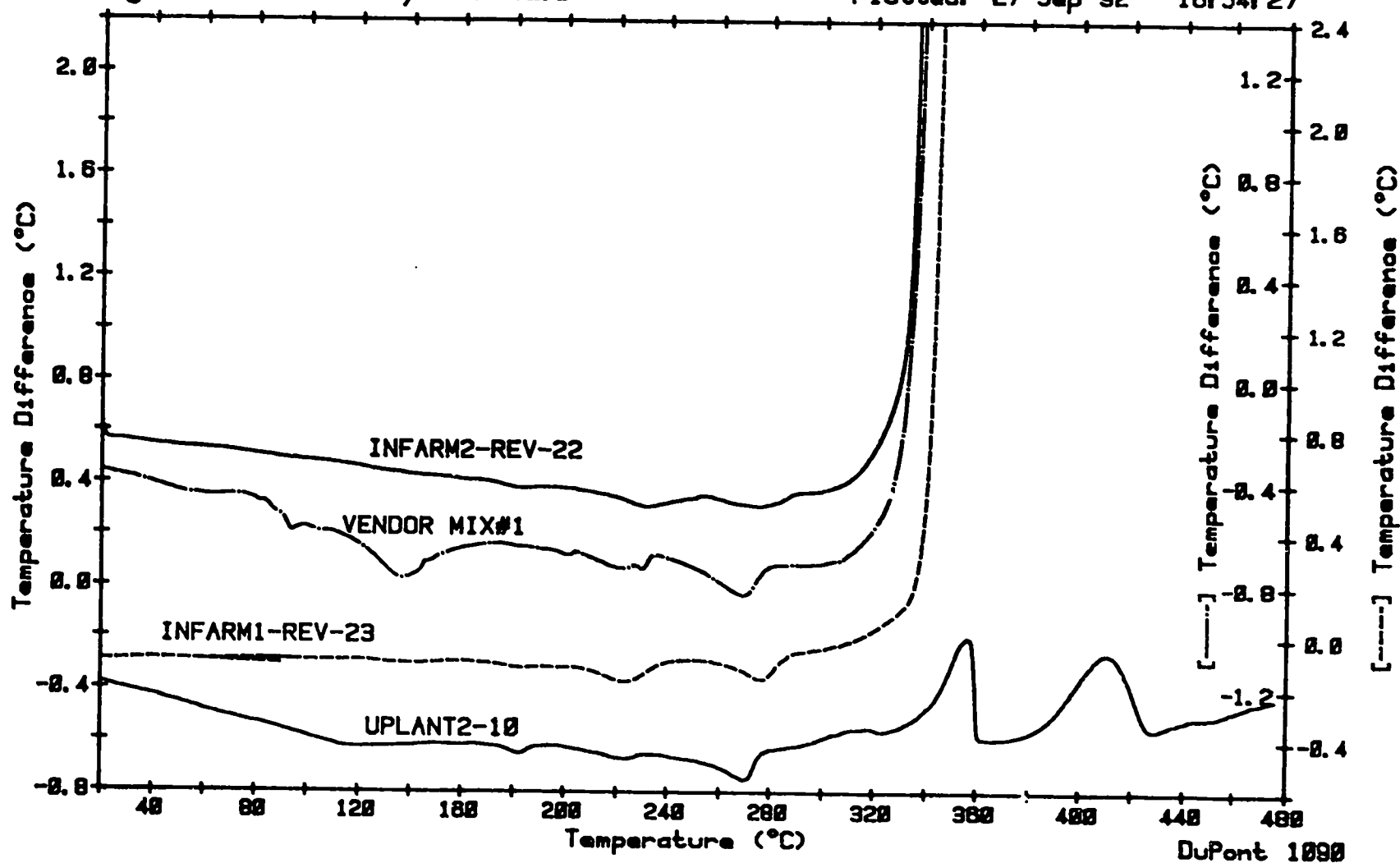

Figure 12. Dry ferrocyanides 20°C-480°C at 5°C/min.

Sample: FERROCYANIDES DRY
Size: MICRO
Rate: 10 DEG C/MIN
Program: Extended Playback V2.0

DTA

Date: 12-Jun-92 Time: 13:33:48
File:
Operator: H. H. CADY
Plotted: 27-Sep-92 14:42:06

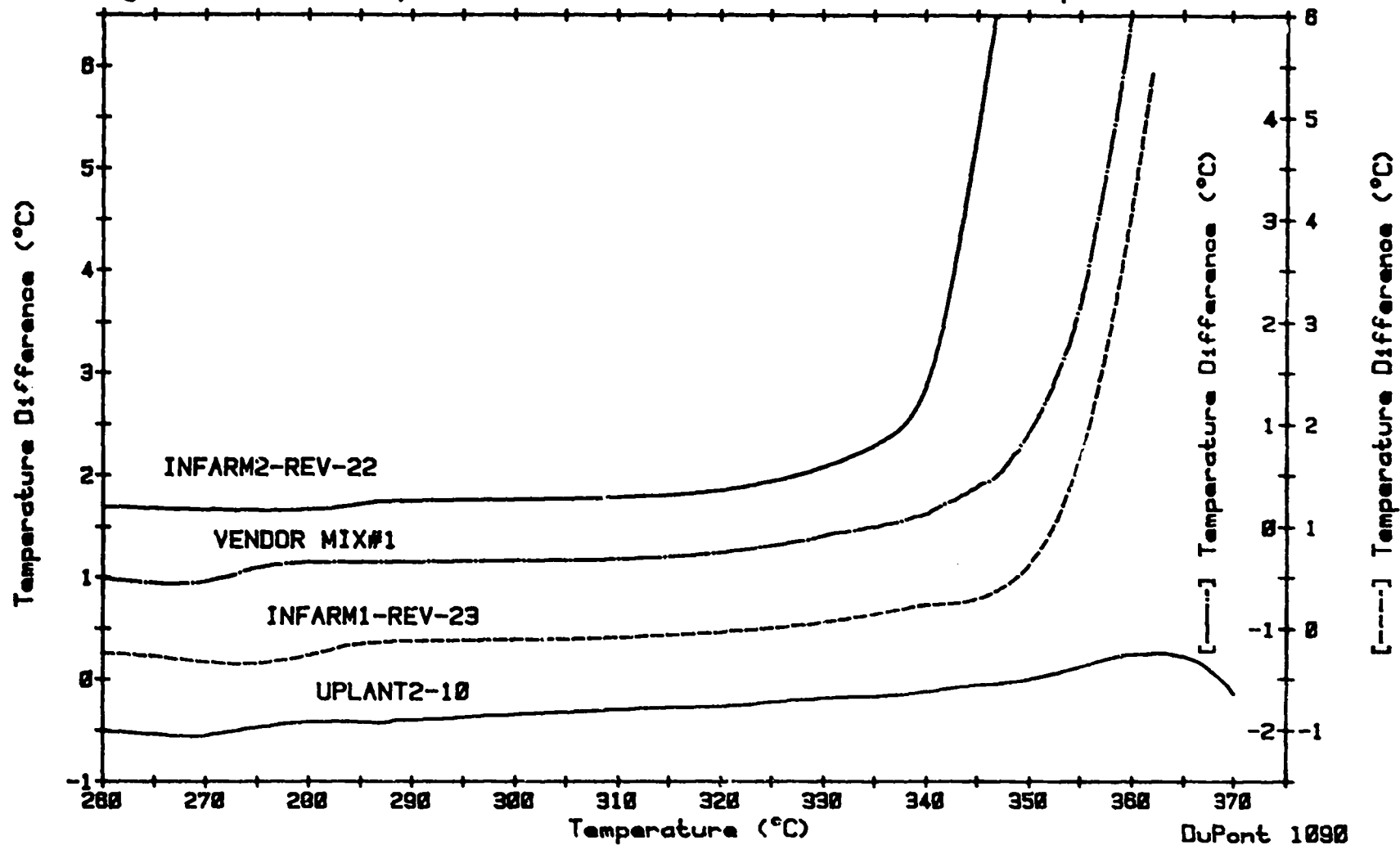

Figure 13. Dry ferrocyanides 260°C-380°C at 5°C/min.

b. Vacuum Thermal Stability (VTS)

(R. Gallegos, J. F. Baytos, E. D. Loughran, T. Rivera)

The VTS or gas evolution on thermal aging test has long been used in the explosives industry. Of the many tests used to characterize the safety of explosives, VTS is a primary indicator of processing safety and compatibility between mixture components. The function of the test is to look for evidence that the gases are liberated at the upper limit of temperatures used to process explosives. Steam is the heat source most common in processing explosives, and 120°C is the normal maximum temperature used to process explosives at LANL. The normal VTS test at LANL measures gas evolved at 120°C over a 48-h period. LANL has developed a special VTS testing apparatus that operates at temperatures up to 300°C. It was decided to use this apparatus for the requested testing of INFARM1-REV-23 at 160°C for 300 hours. This apparatus differs from the normal apparatus in that it can only run one sample at a time, and the sample oven starts at room temperature and reaches its control temperature in about 5 minutes. The normal apparatus uses a hot oil bath, and the sample is heated very quickly. In both cases, the initial pressure reading is taken 5 minutes after the start of the experiment.

Figure 14 is a photograph of the VTS manometer tube and sample tube. Historically, a sample of material was sealed in a test bulb and attached to a manometer tube, which was then evacuated; a small amount of mercury was added to seal the sample from the ambient atmosphere. The test bulb with sample was inserted into an oil bath of known temperature. After equilibration, mercury column height, room and bath temperature, and barometric measurements were taken for starting conditions and converted to give gas volume at standard temperature and pressure (STP). The test bulb with sample remained in the hot oil bath for a period of time during which the material could partially decompose. Any evolved gas would change the height of the mercury in the manometer. After the test was completed, the final height, temperatures, and barometric pressure were again measured, and another STP volume was determined. The amount of gas evolved was calculated as the difference between the starting and final volumes. The apparatus now used at LANL continuously and automatically monitors the parameters needed to calculate STP volume. Gas evolution is reported hourly throughout the test.

Two innovations make the VTS amenable to electronic monitoring. First, the manometer tube is incorporated as a variable capacitance transducer into a circuit that generates a voltage as a function of the height of the mercury column. The second innovation is an air back-pressure system by which the mercury column can be raised precisely by an adjustable pressure

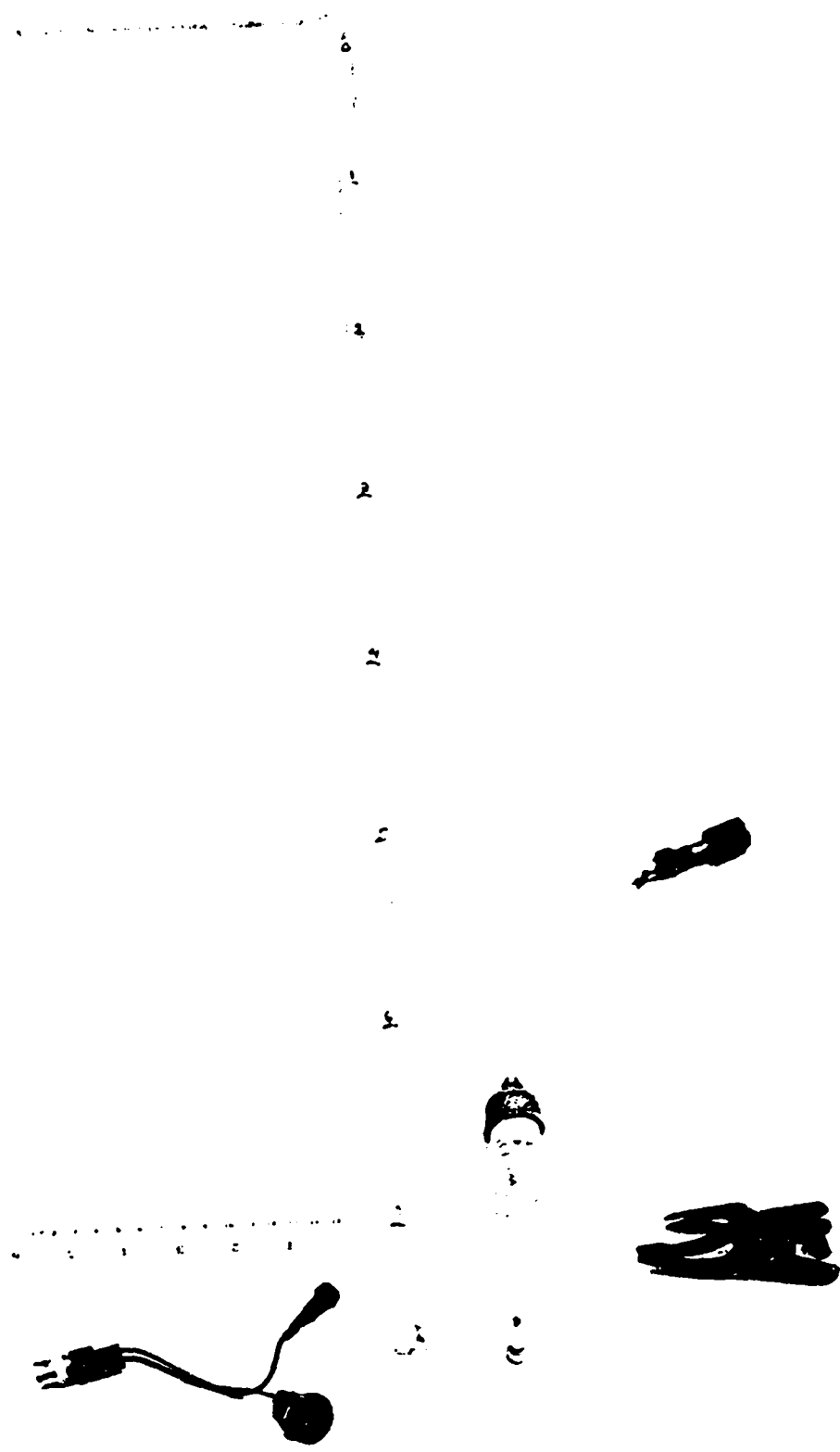

Figure 14. VTS manometer tube and cell.

reduction valve so that the calibration of the voltage as a function of the height of the mercury column can be accomplished *in situ*. This same device provides a constant 760 mm Hg pressure to the manometer Hg pool during a test run.

Other quantities are needed to make the gas volume calculation. The volumes of the sample tube and the manometer tube as functions of mercury level are required. These are obtained by weight of the tubes when empty and filled appropriately with mercury. The manometer is constructed of true-bore glass tubing so that volume is a constant function of mercury height in the region of measurement. Gas evolutions are corrected to STP and normalized to cm^3/g for elapsed time by dividing the measured gas volume by the sample weight.

The high-temperature VTS test apparatus has only one sample port. The same sample tube and manometer were used for all gas evolution measurements. Proper operation of the VTS apparatus was ensured by running standards of 900-10 inert at 120°C and calcium carbonate at 160°C prior to running the dried INFARM1-REV-23 samples. The apparatus functioned normally with the standards. The test results for 900-10 were normal, and the results for calcium carbonate showed no gas evolution with time at 160°C .

The first run with INFARM1-REV-23 gave the results shown in Figure 15. Much more gas was found than was expected from the 0.200-g sample used, and the pressure in the manometer tube reached the maximum for the apparatus of 760 mm Hg in 131 hours. The first run was then terminated. There is an initial burst of gas that is released in the first few minutes as the sample is heated to 160°C . This gave an initial pressure reading of about 50 mm Hg. The pressure then increased at a constant rate for about 30 hours, after which time the rate of pressure rise decreased. We were concerned that the sample had leaked, but convinced ourselves that it could not have happened because the final pressure exceeded local atmospheric pressure (580 mm Hg) and because a substantial portion of the gas in the tube reacted with air turning brown and giving nitrogen dioxide as a product when the tube was opened. Water condensation was not observed in the cooler parts of the manometer tube after one hour, but was clearly evident at the end of the experiment.

The second run with 0.150 g of INFARM1-REV-23 was started. The initial gas burst gave a pressure of about 37 mm Hg. The gas evolution as a function of time is shown in Figure 16. This run lasted 300 h, and ended before the capacity of the apparatus was exceeded. The two normalized gas evolution curves essentially superimpose. Again there was evidence for water condensation and the formation of NO as a product.

Vacuum Stability at 160°C
INFARM1-REV-23
200 mg Sample

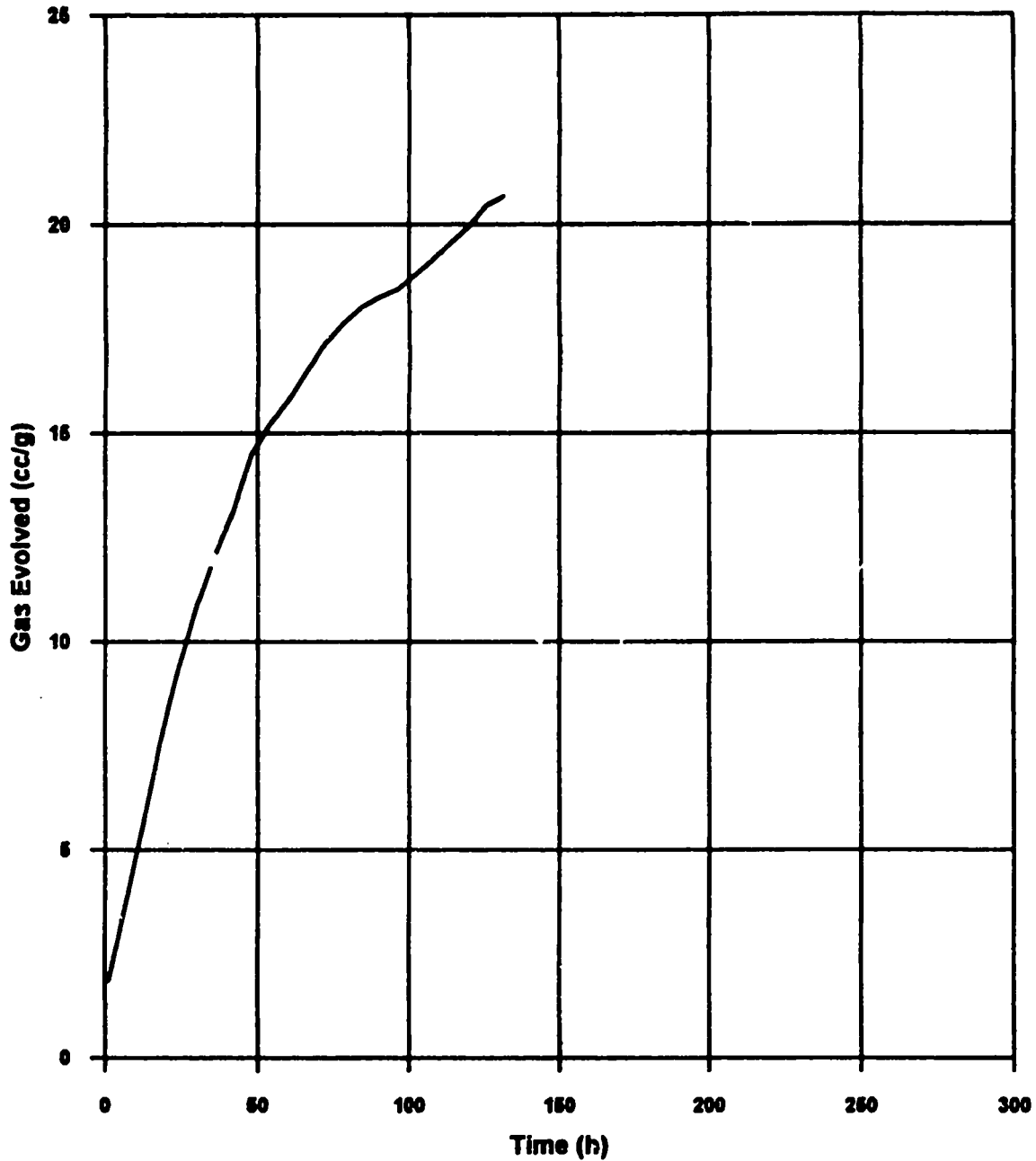

Figure 15. First run of VTS to show gas evolution from INFARM1-REV-23 at 160°C.

Vacuum Stability at 160°C
INFARM1-REV-23
150 mg Sample

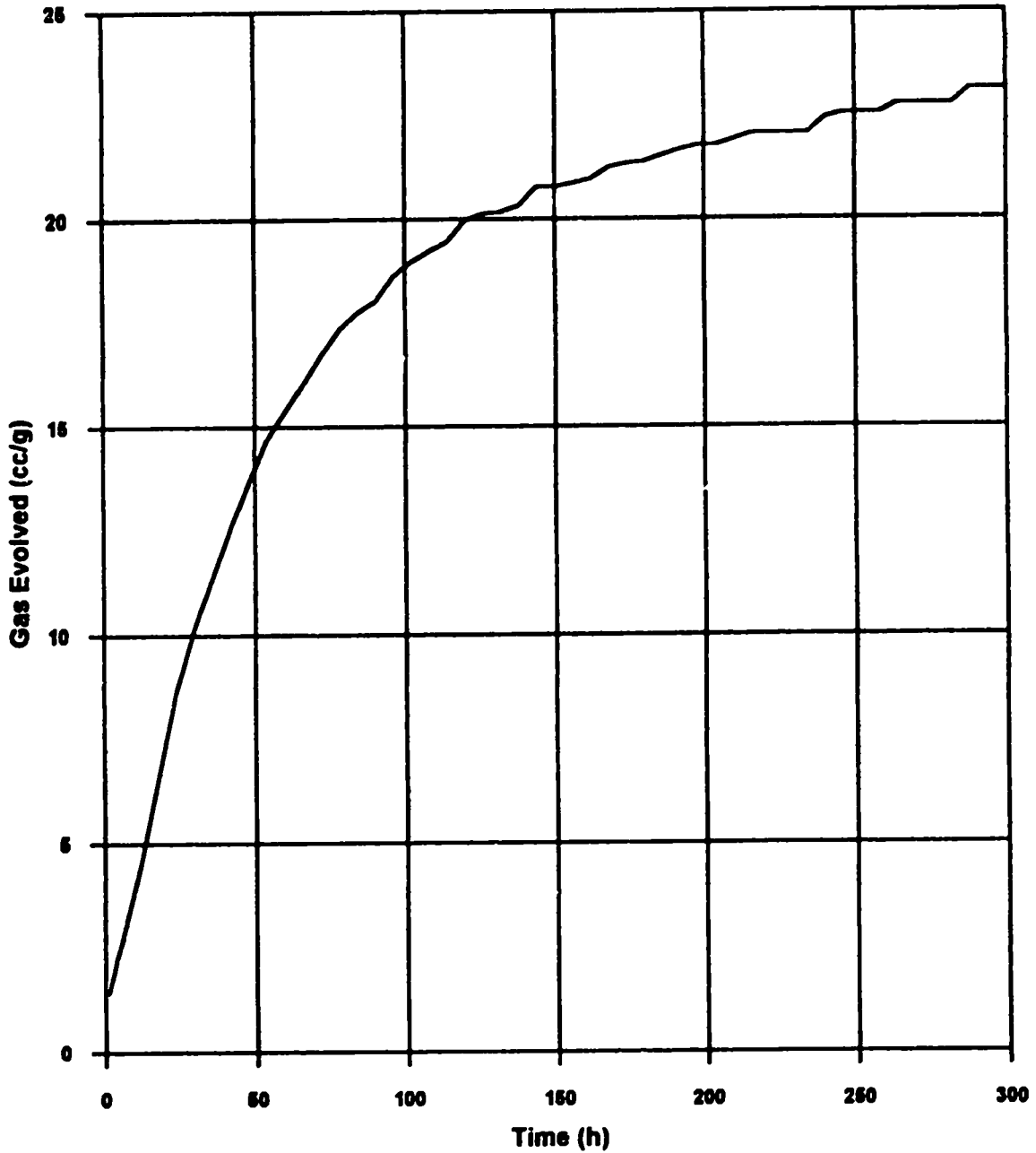

Figure 16. Second run of VTS to show gas evolution from INFARM1-REV-23 at 160°C.

We have an uncalibrated manometer tube that is equipped for mass spectrometer sampling, and it was felt useful to try to identify the product gases produced in the VTS testing. This identification of gases is not included in the Statement of Work for this project. A third run was made where a 0.100-g sample of INFARM1-REV-23 was heated at 160°C for 120 h. The gases in the manometer tube were then analyzed in two mass spectrometer samplings. The raw species analysis data are given in Table 5.

Table 5. Mass Spectral Analysis of VTS Gas for INFARM1-REV-23 Heated at 160°C for 120 h

| <u>Species</u> | <u>1st Analysis</u> <u>(Percent)</u> | | <u>2nd Analysis</u> <u>(Percent)</u> | |
|------------------|---|-----------------|---|-----------------|
| | <u>Found</u> | <u>Std.Dev.</u> | <u>Found</u> | <u>Std.Dev.</u> |
| N ₂ | 67.88 | 0.64 | 48.09 | 0.72 |
| NO | 16.09 | 0.15 | 12.53 | 0.14 |
| CO ₂ | 5.31 | 0.49 | 2.33 | 0.48 |
| N ₂ O | 3.66 | 0.63 | 5.30 | 0.62 |
| CO | 3.15 | 0.58 | 4.35 | 0.56 |
| H ₂ O | 2.92 | 0.03 | 26.56 | 0.12 |
| Argon | 0.67 | 0.01 | 0.51 | 0.01 |
| O ₂ | 0.34 | 0.01 | 0.27 | 0.01 |
| H ₂ | 0.12 | 0.02 | | |
| NH ₃ | 0.06 | 0.02 | 0.02 | 0.03 |
| HCN | 0.01 | 0.01 | 0.02 | 0.01 |
| Cyanogen | 0.00 | 0.01 | 0.01 | 0.01 |

The water analysis is wrong because condensed water is present in the tube when the first sample is removed, and it adds to the second analysis. Eliminating the water contribution and adjusting the other gases to total 100% give a corrected starting analysis shown in Table 6.

Table 6. Water-Corrected Mass Spectral Analysis of VTS Gas for INFARM1-REV-23 Heated at 160°C for 120 h

| <u>Species</u> | <u>1st Analysis</u> <u>(Percent)</u> | <u>2nd Analysis</u> <u>(Percent)</u> | <u>Average</u> <u>Percent</u> |
|------------------|---|---|----------------------------------|
| N ₂ | 69.7 | 65.5 | 67.6 |
| NO | 16.6 | 17.1 | 16.9 |
| CO ₂ | 5.8 | 3.2 | 4.3 |
| N ₂ O | 3.8 | 7.2 | 5.5 |
| CO | 3.2 | 5.9 | 4.6 |
| Argon | 0.69 | 0.69 | 0.69 |
| O ₂ | 0.35 | 0.37 | 0.36 |
| NH ₃ | 0.06 | 0.02 | 0.04 |
| HCN | 0.01 | 0.02 | 0.015 |
| Cyanogen | 0.00 | 0.01 | 0.005 |

It is difficult to think of a source for argon other than air. If the argon came from air in its natural abundance, then there should have been a corresponding 58% N₂ and 15% O₂ in the analysis. The O₂ would have reacted with NO to make NO₂, the NO₂ would in turn react with the mercury in the manometer to regenerate NO. All of this implies that about 60% of the pressure in the sample may be from air and about 40% of the pressure would be decomposition products (water at a pressure of 20 mm is neglected). If there are no leaks in the VTS apparatus, then this requires an air absorption of about 13 cc/g of dried INFARM1-REV-23 that is not removed by pumping for several minutes and is not desorbed in several hours at 160°C. All of this seems quite improbable, and we would suggest further mass spectrometry sealed-bulb (without mercury) experiments to clarify the low-temperature decomposition of the INFARM materials. We have been unable to find any significant source of error in the VTS gas evolution experimental measurements shown in Figures 15 and 16. This experiment does imply that there is a significant weakly energetic, or perhaps even endothermic, decomposition reaction for ferrocyanide/- nitrate/nitrite/water mixtures at 160°C. (If we assume a 160°C hotspot created by radioactive Cs, would the decomposition of hotspot ferrocyanide release the Cs for migration and provide a means for dissipating the hotspot over a long period of time?)

c. Henkin Critical Temperature
(M. M. Stinecipher)

All explosives and many other materials decompose exothermically at temperatures above absolute zero. When chemical decomposition produces gases and heat faster than it can be dissipated to the surroundings, the explosive mass self-heats to explosion. In steady-state conditions, the lowest temperature at which a thermal explosion is produced is called the critical temperature, T_m. A relatively simple expression has been derived in terms of the kinetic and physical parameters.

$$T_m = \frac{E}{R \cdot \ln \left[\frac{A^2 \cdot \rho \cdot Q \cdot Z \cdot E}{T_m^2 \cdot \lambda \cdot \delta \cdot R} \right]}$$

where

R = Gas constant, 1.987 cal / mol / K
 A = radius of sphere, cylinder, or half thickness
of a slab
 ρ = density
 Q = heat - of - decomposition reaction
 Z = pre - exponential factor
 E = activation energy
 λ = thermal conductivity
 δ = shape factor (3.32 for spheres, 2.0 for
infinite cylinders, or 0.58 for infinite
slabs).

The LANL method for determining critical temperatures is based on a time-to-explosion test developed by Henkin. The explosive, usually 40 mg, is pressed into a DuPont E-83 aluminum blasting cap shell and covered with a hollow, aluminum, skirted plug. A conical punch is used to expand the plug and apply a reproducible 400-lb force. This plug expansion forms a positive seal and confines the sample in a known geometry. The density, which can be calculated from the sample weight and a sample thickness measurement, is usually about 90% of the crystal density.

This assembly is placed into a preheated liquid metal bath, and the time-to-explosion is measured as the time to the sound (or rapid movement of the plug) created by the rupture of the blasting cap or the unseating of the plug. The lowest temperature at which a runaway reaction can be obtained is the T_m . Many tests are required to confidently determine T_m because it is necessary to raise and lower the bath temperature across the apparent T_m , perform many separate tests, and allow enough time for a reaction. A "safe" criterion for 40-mg samples is no explosion in 1000 seconds. We have never obtained an explosion after 10,000 seconds.

Because the reactions can be violent, we use the metal-bath enclosure shown in Figure 17. The baffles contain most of the hot metal in the chamber, and the test can be conducted behind a shield in a fume hood.

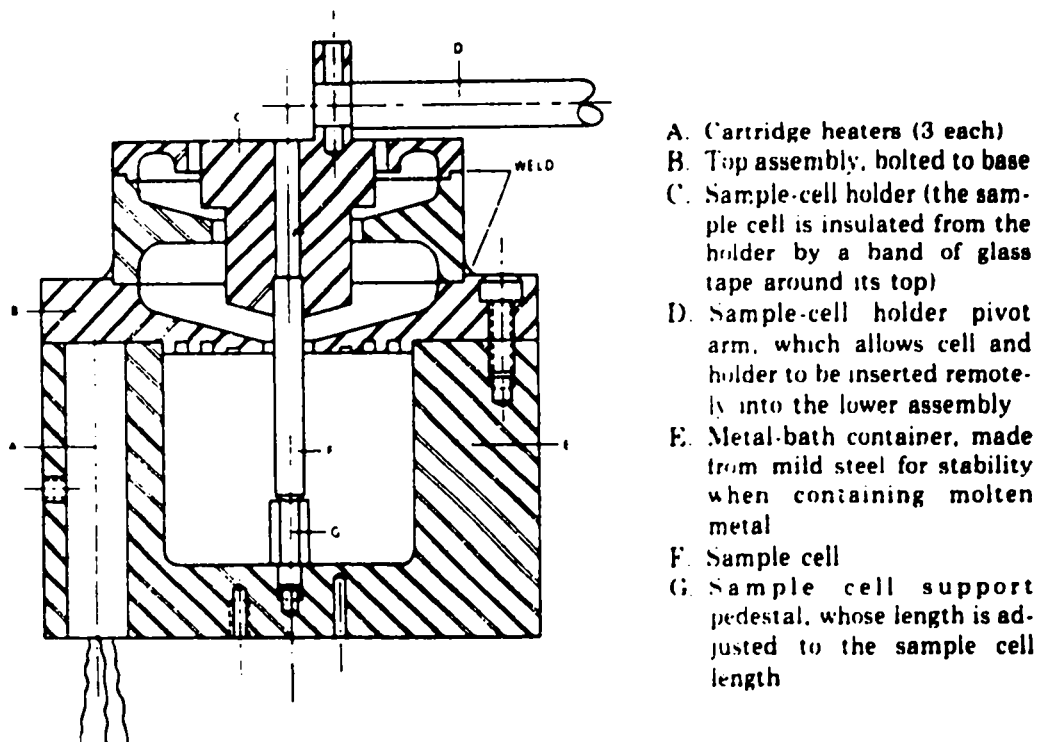

- A. Cartridge heaters (3 each)
- B. Top assembly, bolted to base
- C. Sample-cell holder (the sample cell is insulated from the holder by a band of glass tape around its top)
- D. Sample-cell holder pivot arm, which allows cell and holder to be inserted remotely into the lower assembly
- E. Metal-bath container, made from mild steel for stability when containing molten metal
- F. Sample cell
- G. Sample cell support pedestal, whose length is adjusted to the sample cell length

Figure 17. Henkin critical-temperature metal-bath assembly.

Proper operation of the Henkin critical-temperature apparatus was ensured by running a sample of RDX-based extrudable plastic-bonded explosive (EXTEX) and determining its critical temperature. The uncorrected-temperature, time-to-explosion data are shown in Figure 18. The four "no go" points are plotted at 300 seconds, but the actual experimental times ran to 1800 seconds. The corrected measured value of 220°C is normal for RDX containing silicon rubber binder; it is slightly higher than the value 216°C for normal production grades of RDX.

The uncorrected-temperature, time-to-explosion data for dried INFARM1-REV-23 are shown in Figure 19. The "no go" points are plotted at 2000 seconds even though the actual experimental times ran as long as 11280 seconds. After temperature correction, the critical temperature is 311°C. The Henkin critical temperatures for the EXTEX standard, FECN-1, INFARM1-REV-23, and several standard explosives are reported in Table 7.

It must be remembered that these data reflect only one point on a critical temperature versus sample-thickness curve, and represent a very thin sample from which heat is easily removed by thermal conduction. Explosion temperatures for all these materials will be substantially lower for large masses of material.

Table 7. Henkin Critical Temperature

| <u>Material</u> | <u>T_m</u> <u>(°C)</u> | <u>a</u> <u>(mm)</u> |
|-----------------|-------------------------------------|-------------------------|
| RDX (EXTEX) | 220 | 0.24 |
| INFARM1-REV-23 | 311 | 0.35 |
| FECN-1 | 367 | 0.29 |
| PETN | 192 | 0.34 |
| RDX | 216 | 0.35 |
| HMX (Rex UK) | 257 | 0.33 |
| TNT | 286 | 0.38 |
| TATB (purified) | 353 | 0.33 |

**Henkin Test
EXTEX 8004 (RDX Based)
Batch 7026**

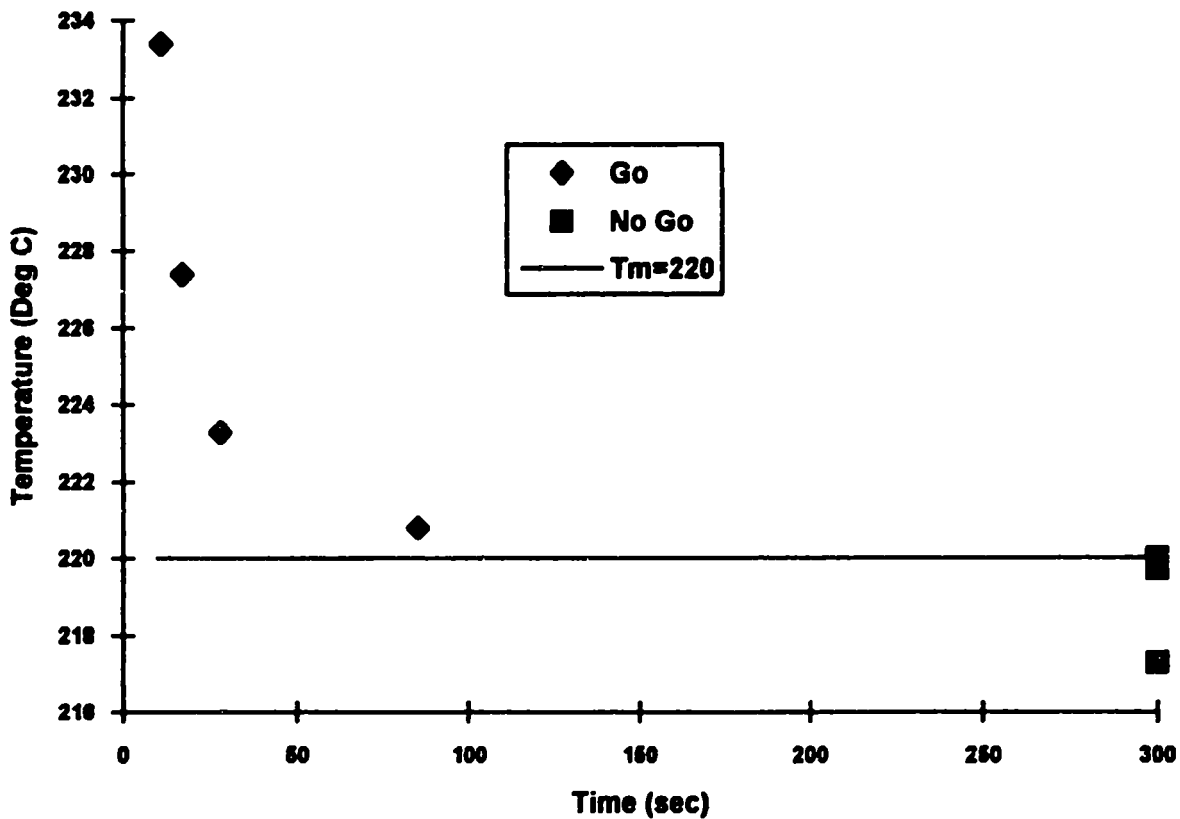

Figure 18. Time-to-explosion data for RDX-based EXTEX.

Henkin Test
INFARM1-REV-23

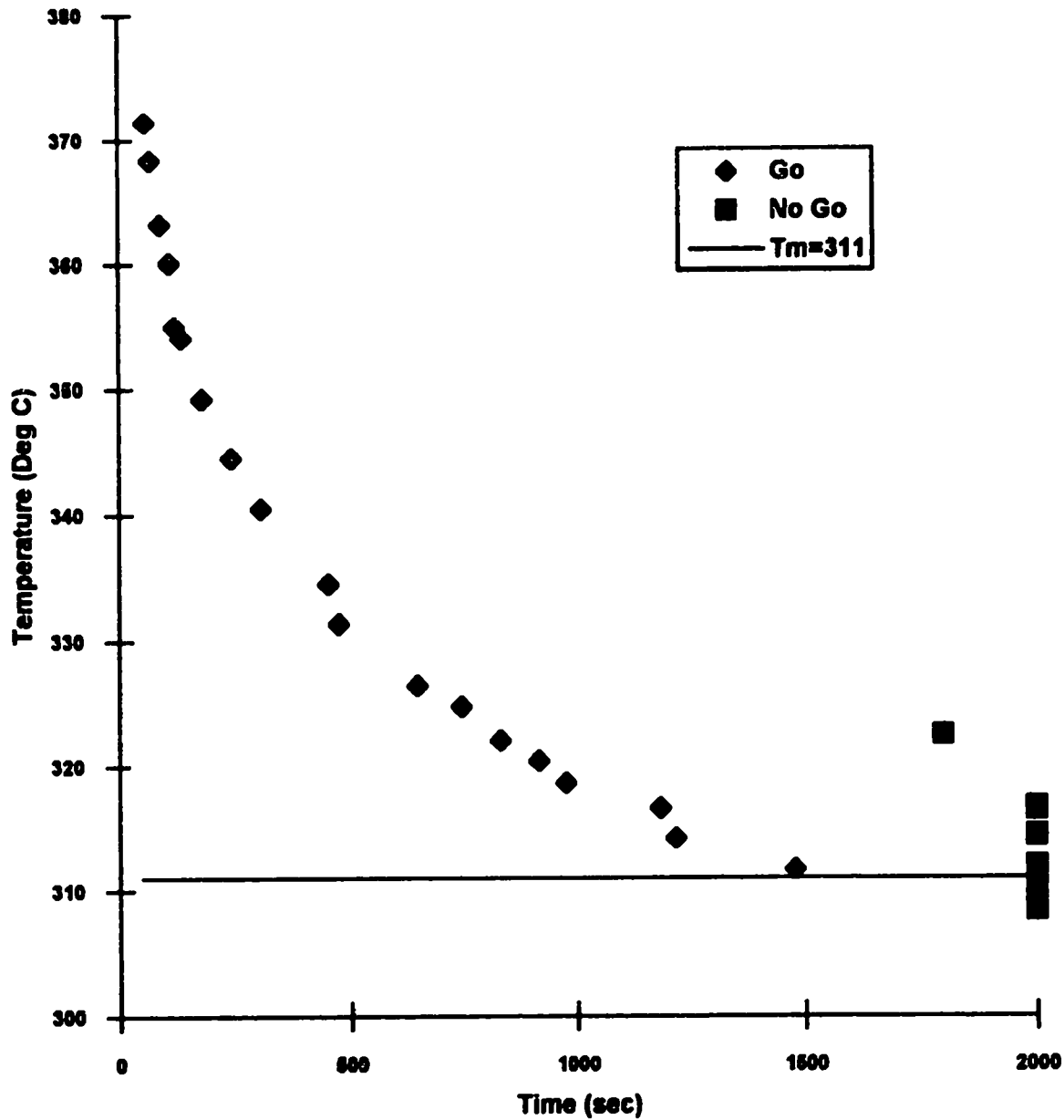

Figure 19. Time-to-explosion data for dried INFARM1-REV-23.

d. Accelerating Rate Calorimetry (ARC)
(M. M. Stinecipher)

The Columbia Scientific Industries ARC used at LANL is our most sensitive apparatus for studying heat evolved from reacting materials.

The ARC is an analyzer for hazard evaluation of exothermic reactive chemicals. Its primary function is to maintain a sample and its cell in an adiabatic state and permit the sample to undergo thermal decomposition caused by self-heating while recording the time-temperature relationship for a runaway process.

The key objective in ARC design and construction is the maintenance of near perfect adiabatic conditions. To accomplish this, the sample cell is placed inside a nickel-plated, copper jacket equipped with strategically located thermocouples and heating elements to produce a uniform jacket temperature and a sample cell to jacket temperature difference of zero.

Although the sample, cell, and jacket are all that is theoretically necessary to carry out a measurement, the length of the run may be months, years, or more if begun under ambient conditions. Therefore, the ARC is equipped with a radiant heater that is used to step the sample temperature up to a level where the self-heat rate is such that the run duration is acceptable.

Once a self-heat rate is detected, as evidenced by a slow, steady temperature increase, the sample is left adiabatic to complete its thermal spiral. From recorded data for the experimental system of sample plus cell, one can measure:

- time/temperature runaway curve,
- adiabatic temperature rise,
- temperature of maximum rate,
- time-to-maximum rate,
- self-heat rate at any temperature.

From these data, it is possible to predict the behavior of the isolated chemical as well as the behavior of the chemical in other systems (e.g., drums, tank cars, and process equipment). These results assist in making an accurate hazard prediction of the reactive chemical. In addition, the various kinetic parameters that describe the decomposition reaction may be studied.

The ARC is fully automated and requires minimal operator attention during a run. The system consists of the adiabatic calorimeter, containment vessel, jacket heater power supply and interface, central control microprocessor unit, and recorder for

data plots. Figure 20* illustrates the internal logic and control schematic of the ARC microprocessor system.

The logic used to search for and follow an exotherm is programmed to permit user selection of run parameters and to provide display of critical variables such as time and temperature. The search for a reaction exotherm is accomplished by elevating the sample temperature by a fixed increment (step heat), then checking to see if the self-heat rate exceeds a user-selectable threshold (0.009°C/min for INFARM1-REV-23). Once an exotherm is detected, automatic collections of time and temperature data are carried out until the self-heat rate has dropped back below the threshold value. This will occur when the reaction is finished, or it can occur when an endothermic reaction, such as a phase change, is encountered. Figure 21* illustrates a typical run sequence used to detect and follow an exothermic runaway reaction.

The microprocessor provides continuous control of the temperature difference between the sample and three separate zones of the calorimeter jacket (top, side, and bottom) for adiabatic conditions. Sample and jacket thermocouple inputs, span, and zero reference voltages are multiplexed through a voltage-to-frequency converter circuit to provide stable, low-noise operation. At low self-heat rates, further filtering of thermocouple inputs is achieved by time averaging of signals.

A Kaye ice point references the thermocouples to 0.0°C for accurate and stable temperature measurement. The ice point is stable to within 0.01°C. Electronic cold junction compensation is not suitable for use with the ARC.

Figure 22* illustrates the calorimeter and sample cell. The calorimeter package consists of an insulated aluminum canister that houses the calorimeter jacket, and sample cell assembly, and provides connections for thermocouples, heating elements, pressure transducer, and jacket cooling air. This calorimeter package is mounted inside a rugged vessel for containment of pressure in the event of a ruptured sample cell and for venting of toxic gases that may be produced during a run. Experience has shown that the calorimeter package and rugged vessel can easily sustain the rupture of a sample cell. However, the calorimeter package can essentially be destroyed by the explosion of 5 g of HMX; therefore, we operate with 0.5-g samples to prevent excessive damage to the calorimeter.

The calorimeter jacket is constructed of nickel-plated copper.

* Figs. 20, 21, and 22 are taken, with permission, from *Accelerating Rate Calorimetry "ARC" General Description of Operations and Theory*, (Columbia Scientific Industries, Austin, Texas, circa 1979), pp 5,6, and 10.

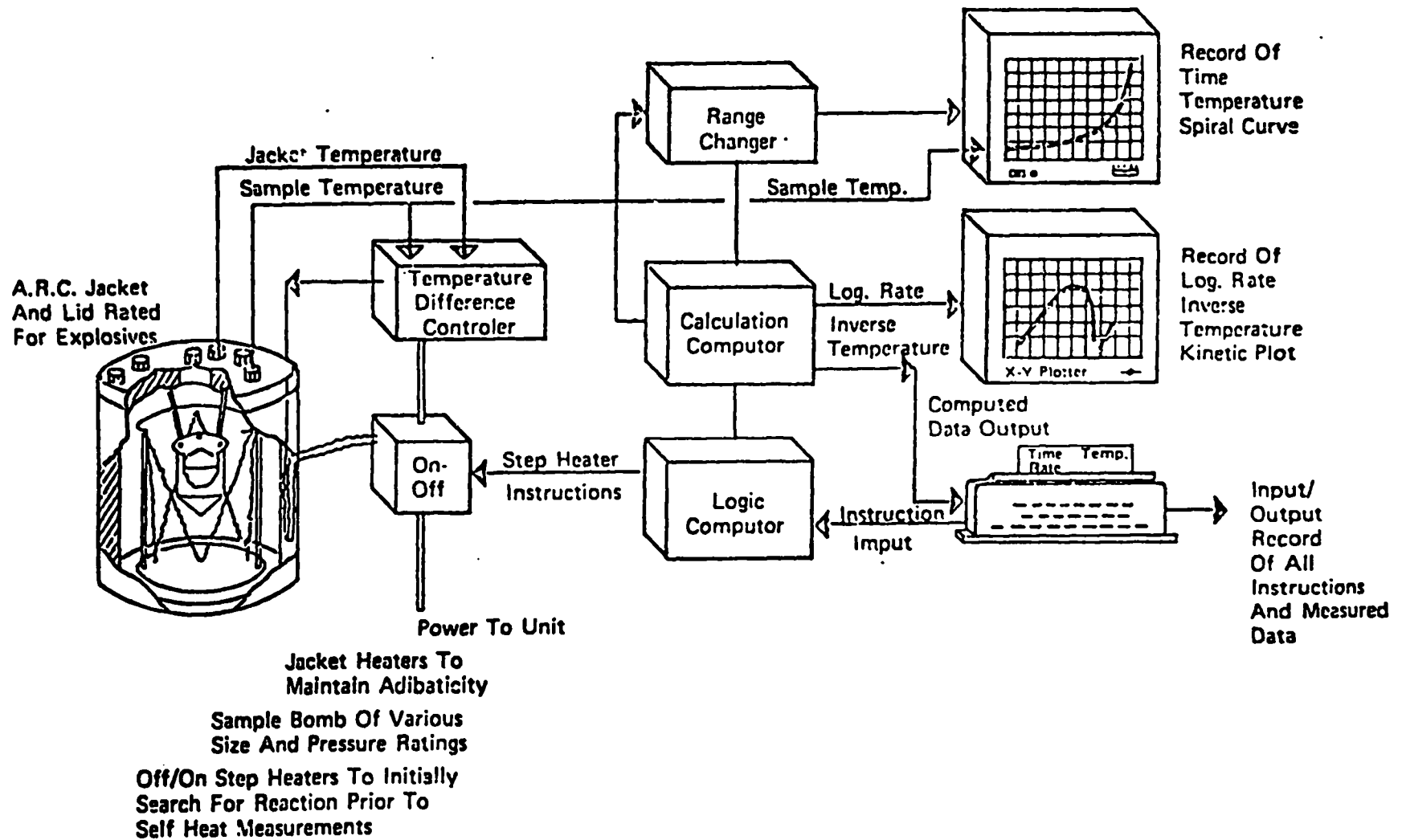

Figure 20 . ARC internal logic schematic.

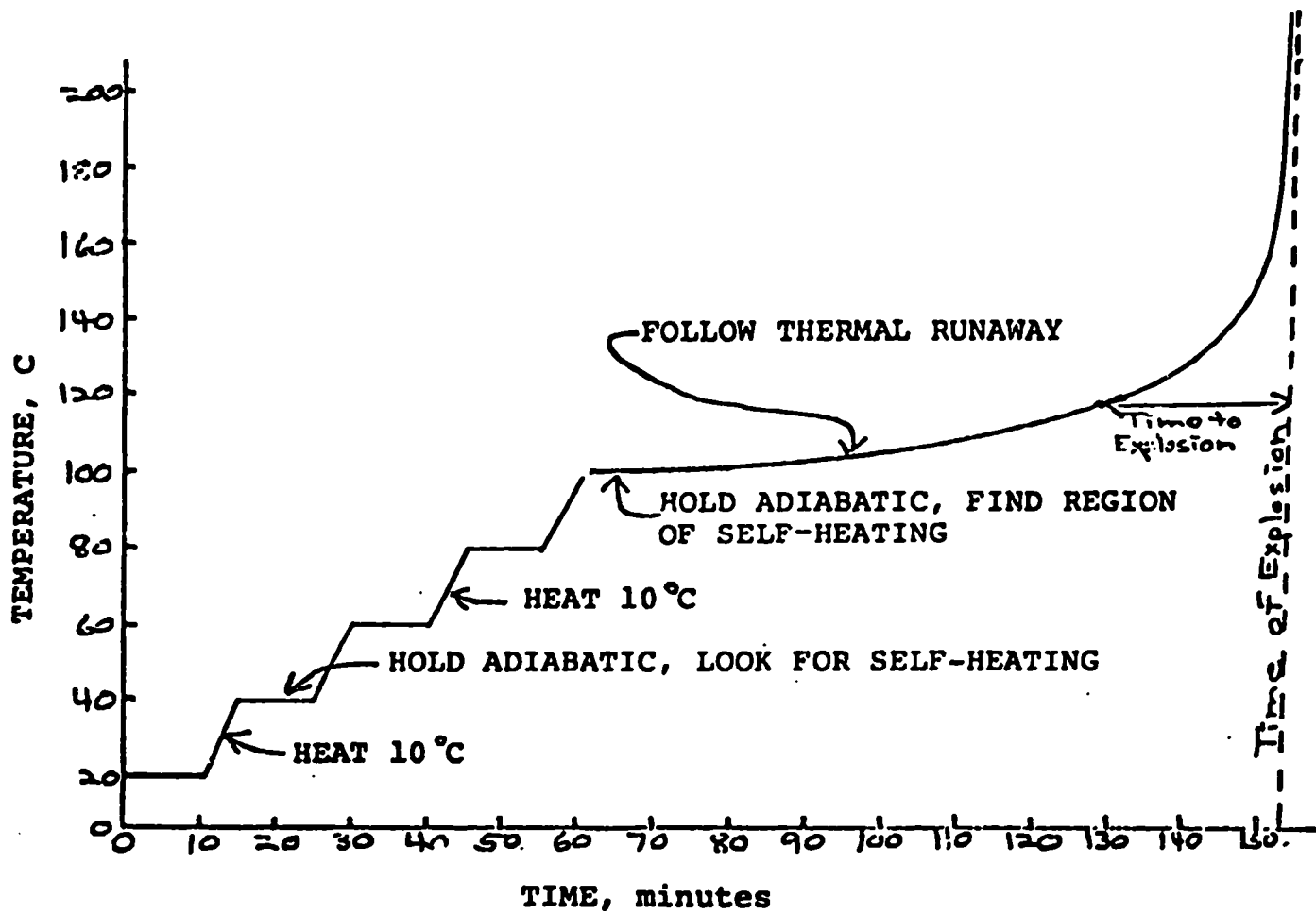

Figure 21. Typical ARC step run with exothermic reaction.

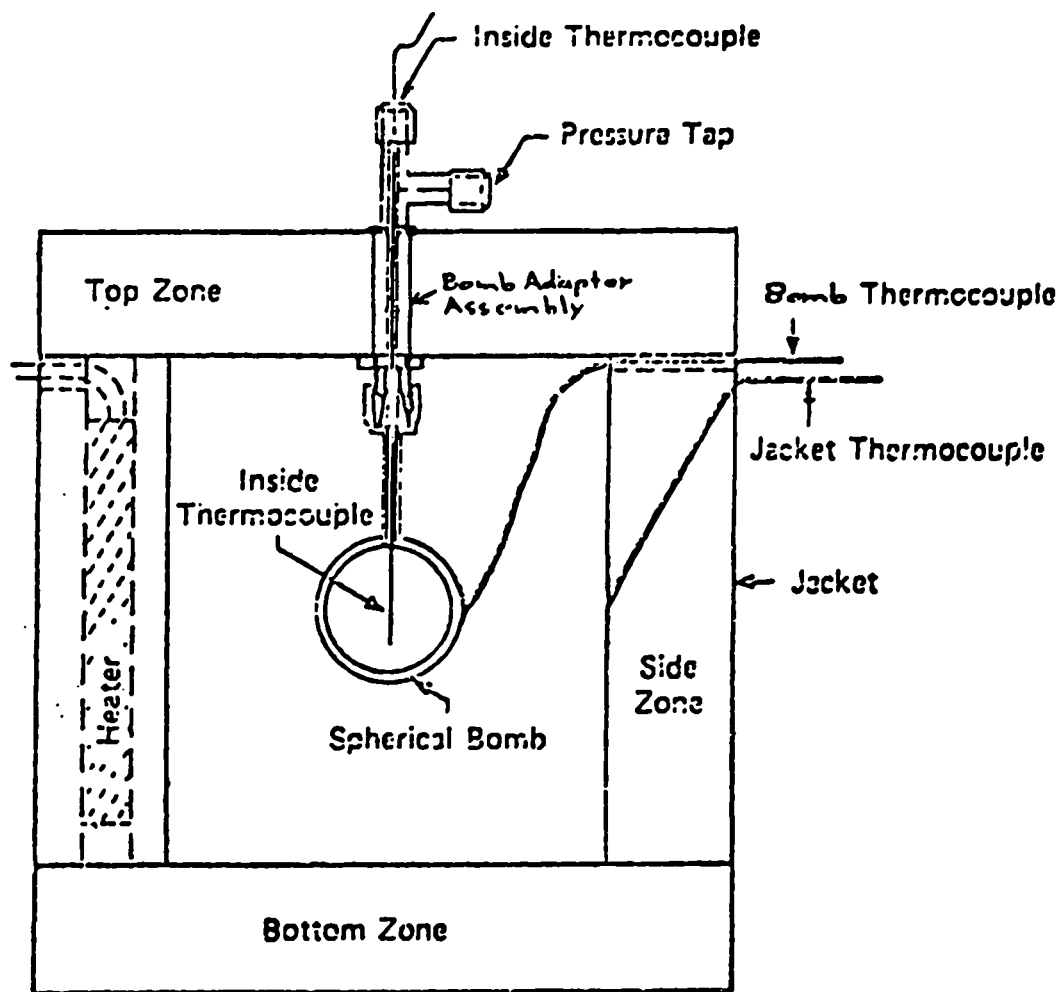

Figure 22. ARC calorimeter package and sample cell.

This composition limits operation of the calorimeter to about 400°C to prevent degradation by high-temperature oxidation. The jacket is divided into three zones: top, side, and bottom. The temperature of each zone is independently controlled by a thermocouple that detects average temperature. The calorimeter heaters have sufficient capacity to raise the calorimeter-jacket temperature at a rate of 15°C/min. The inside thermocouple indicated in Figure 22 is not used.

The sample cell is constructed of corrosion-resistant Hastelloy C. At the tops of the cells, we replace the Swagelok fittings with Cajun fittings for a better seal. Stainless steel gas seals are used to confine reaction products to the sample cell while the measurements of interest are taken.

The sample-cell temperature is measured by a thermocouple clamped directly on the outside surface of the cell. At high self-heat rates of a reacting sample, the sample temperature may be substantially higher than the surface of the cell. This condition only occurs shortly before an actual explosion and is not particularly important for hazard assessment. Hazard prediction depends almost exclusively on the lower or initiation part of the reaction. Also, at high self-heat rates the calorimeter-jacket temperature cannot be raised fast enough to maintain adiabatic conditions. IT IS IMPORTANT TO RECOGNIZE THAT, EVEN THOUGH THE CALORIMETER IS ADIABATIC, THE TEMPERATURE-TIME BEHAVIOR OF THE CELL WITH SAMPLE DOES NOT MIMIC THE EXPECTED TEMPERATURE-TIME BEHAVIOR OF AN ISOLATED SAMPLE OF INFARM1-REV-23 BECAUSE THE HEAT CAPACITY OF THE CELL IS MUCH LARGER THAN THE HEAT CAPACITY OF THE SAMPLE INSIDE THE CELL.

We use a two-pen, multiple-span, strip-chart recorder to monitor ARC experiments. Full-scale range is 10°C. One pen records actual sample temperature, and the other pen records the difference in temperature between the cell and the calorimeter jacket.

Two ARC runs were made for this project. The results of the first run were reported in draft#1 of the Predecisional Project Report. Careful examination of the raw data indicated that the results of the first run could have been in error. The ARC was then disassembled, and the sample-cell thermocouple broke during disassembly indicating incipient failure of the thermocouple in the previous run. We believe the results of the first run should be ignored, and they are not reported in this final report. The results of the second ARC run after replacement of the thermocouple follow.

Proper operation of the ARC was ensured by performing a calibration run on an empty sample cell to check that the actual temperature drift of the sample cell was zero or slightly negative (but no more than -0.005°C/min) for all temperatures between 50

and 450°C. A sample of HMX (BGW Q528) was then run in the step mode starting at about 50°C with 10°C steps. After each step, 10 min were allowed for the calorimeter to equilibrate, and then 20 min were used to test the self-heat rate for an exothermic reaction. If an exothermic reaction was not detected within 20 min, the step was repeated.

The data showed an endothermic reaction while the ARC was testing for reaction at 182°C (corrected temperature). This was caused by the HMX-I-to-HMX-II phase transition. Steps to 163°, 203°, and 213°C, showed no evidence of an exothermic reaction. A rapid exotherm started after the step to 223°C, and the cell temperature rose 25°C over the next 70 min. At that point, the calorimeter lost control, and the temperature rose to 366°C within 10 min. The experiment was then terminated. The sample cell did not rupture; this was desirable because the calorimeter was not subject to damage. The ARC was operating as expected with this energetic material.

ARC experiment of INFARM1-REV-23

The cell was loaded with a 0.5312-g sample of dried INFARM1-REV-23, and step heated in 10°C increments starting at about 52°C. Initial self-heat rates after each step were normal until the temperature step to 163°C. The temperature drifts after steps to 163, 173, 183, ... 213°C were negative enough to indicate an endothermic process. Melting of a eutectic is a probable process. After the step to 223°C, the endotherm changed within 6 min to an exotherm of sufficient intensity to switch the calorimeter to its adiabatic, temperature following mode. This initial exotherm required about 6 hours for the temperature to rise 7.3°C. If one assumes a heat capacity of .25 cal/g-°C for INFARM1-REV-23, then the heat of this first reaction is estimated to be 33 cal/g. The rate of heat evolution then dropped sufficiently for the calorimeter to resume its 10°C-step heating mode. Evidence for weak exothermic activity was observed after steps to 241 and 252°C. The major exotherm started after the step to 264°C. The calorimeter followed this exotherm for 480 min while the temperature increased by 55.9°C. This temperature rise gives an estimate of 253 cal/g for the heat of this reaction. There was no evidence for any further exothermic reaction as the sample was heated from 320°C to 410°C.

The implication of this experiment is that already dried INFARM1-REV-23 would start to react exothermically at about 223°C, and it would self-heat to a final temperature of about 1363°C. However, INFARM1-REV-23 contained at least 46% water when received. This means that its heat of reaction is only sufficient to vaporize about 2/3 of its water, and complete reaction of the sample could not raise the temperature of wet INFARM1-REV-23 above the boiling

point of water: a temperature that is 123°C below the temperature where exothermic reaction could start. It is no wonder that INFARM1-REV-23 in its wet form appears completely inert in all of our explosives hazard tests.

**APPENDIX
FERROCYANIDE DTA CURVES**

Sample: INFARM1-REV-23 DRY
Size: MACRO 0.0233 G
Rate: 5 DEG C/MIN
Program: Extended Playback V2.0

DTA

Date: 4-Jun-92 Time: 15:07:08
File: DTA.36 DTA22
Operator: H. H. CADY
Plotted: 11-Sep-92 14:50:31

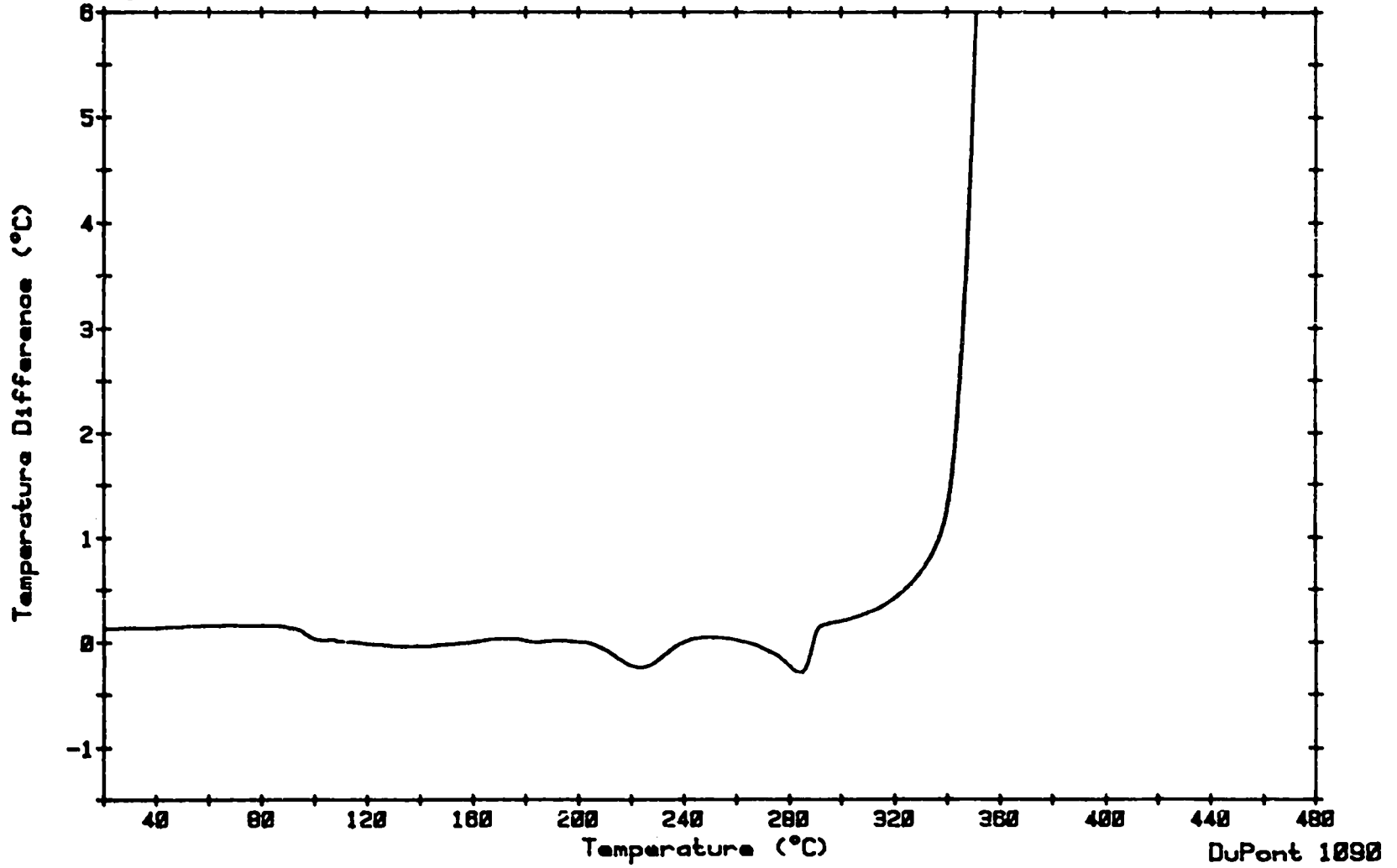

47

Figure A-1. INFARM1-REV-23, dry, macro, 5°C/min.

Sample: INFARM1-23 WET
Size: MACRO 0.039 G
Rate: 5 DEG C/MIN
Program: Extended Playback V2.0

DTA

Date: 2-Jun-92 Time: 11:40/82
File: DTA.33 DTA22
Operator: H.H. CADY
Plotted: 11-Sep-92 14:38:25

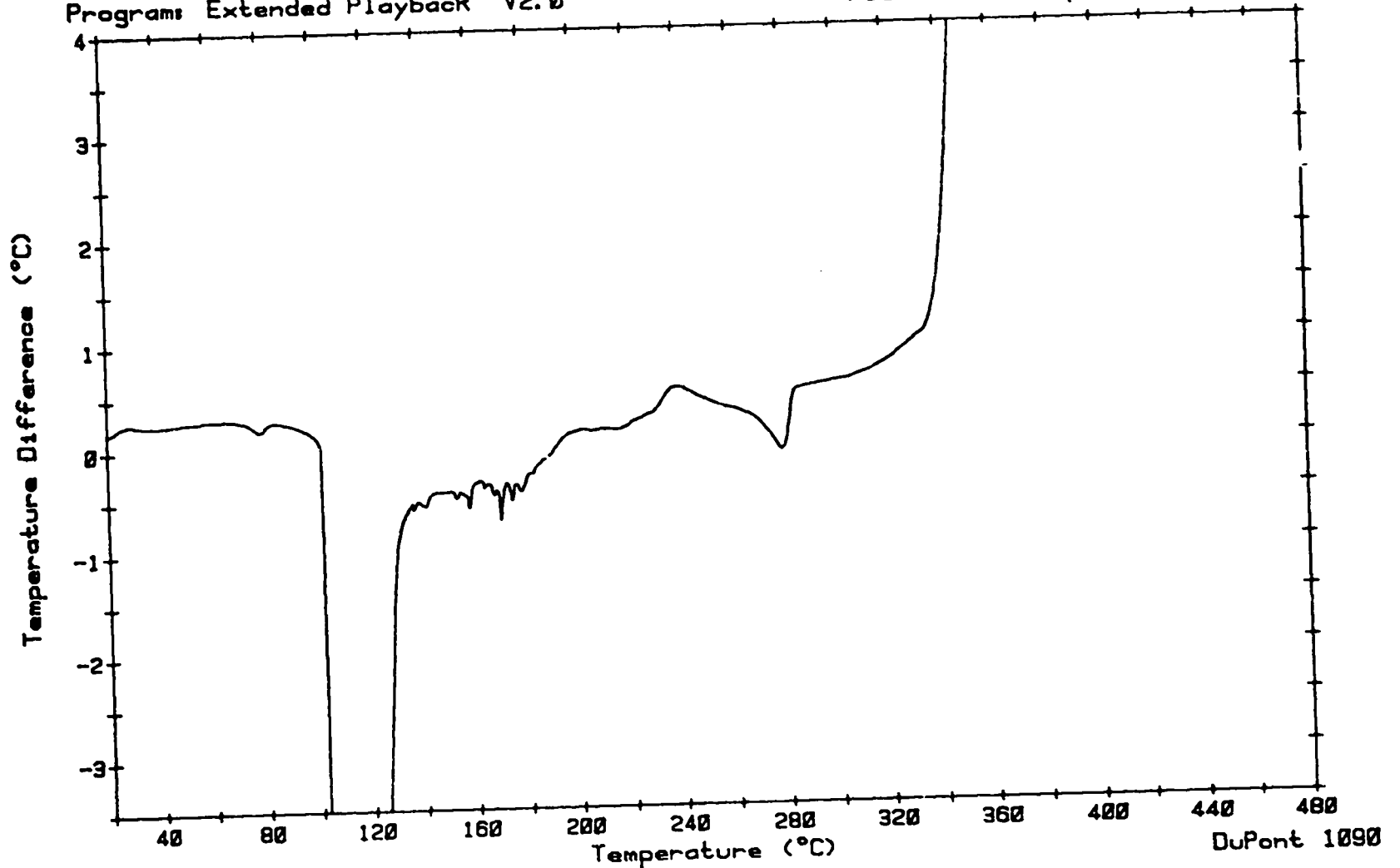

Figure A-2. INFARM1-REV-23, wet, macro, 5°C/min.

Sample: INFARM1-23 WET
Size: MACRO 0.039 G
Rate: 5 DEG C/MIN
Program: Extended Playback V2.0

DTA

Date: 2-Jun-92 Time: 11:40:32
File: DTA.33 DTA22
Operator: H.H. CADY
Plotted: 11-Sep-92 14:18:56

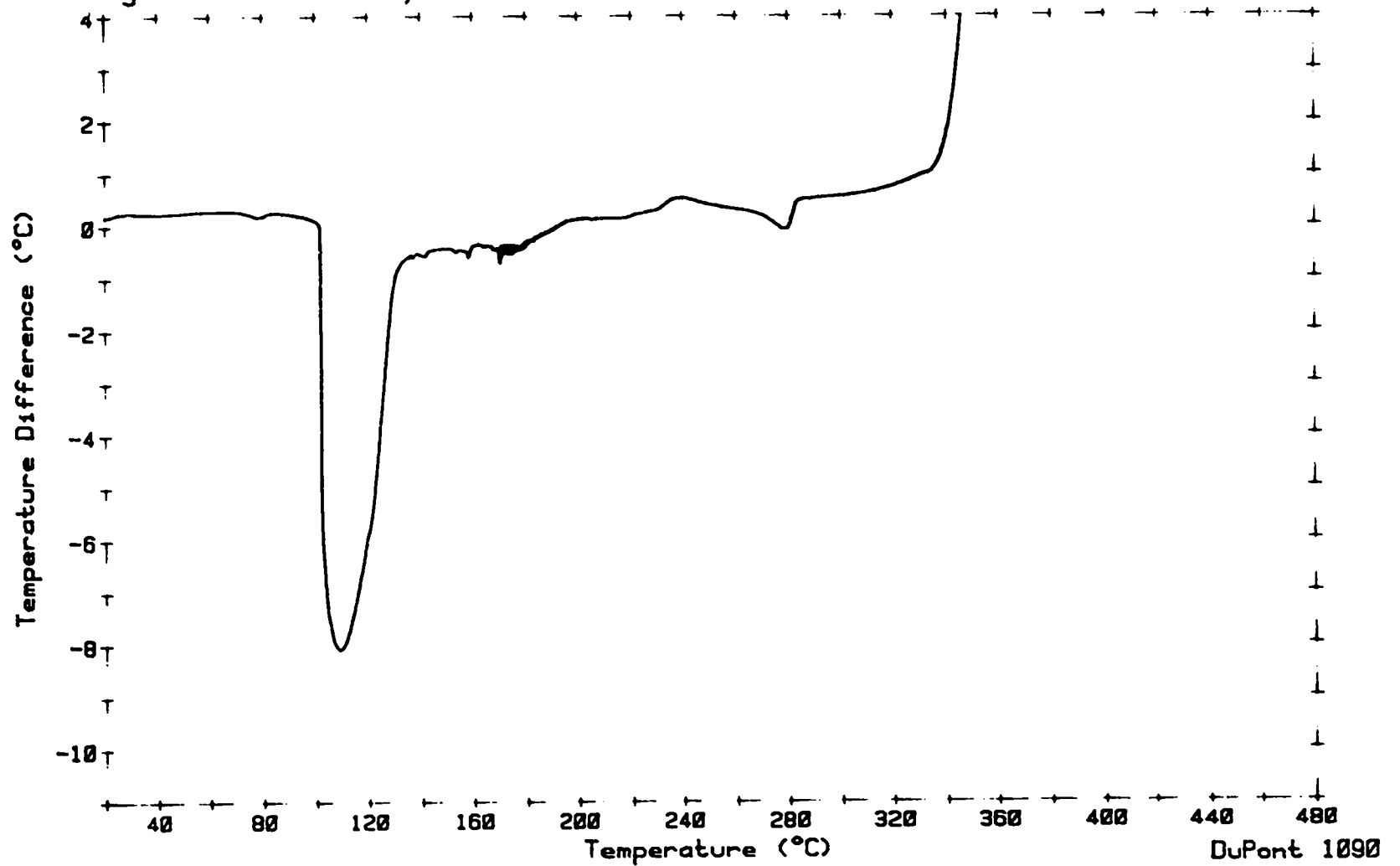
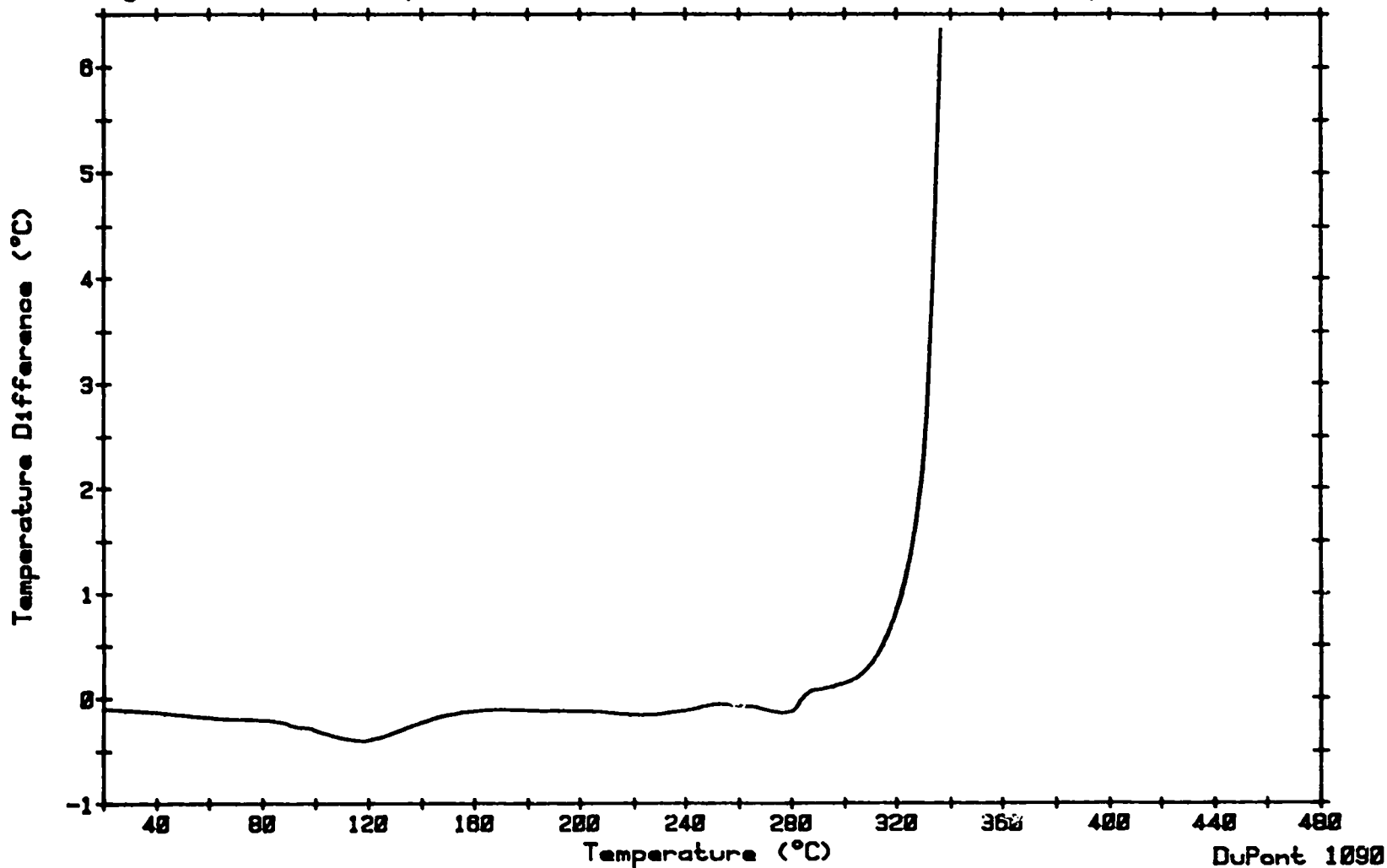

Figure A-3. INFARM1-REV-23, wet, macro, 5°C/min.

Sample: INFARM2-22 DRYED/EQUIL
Size: MACRO 0.013 G
Rate: 5 DEG C/MIN
Program: Extended Playback V2.0

DTA

Date: 2-Jun-92 Time: 13:44:21
File: DTA.34 DTA22
Operator: H. H. CADY
Plotted: 11-Sep-92 15:16:38



50

Figure A-4. INFARM2-REV-22, dry, macro, 5°C/min.

Sample: INFARM2-22 WET
Size: MACRO 0.0420 G
Rate: 5 DEG C/MIN
Program: Extended Playback V2.0

DTA

Date: 1-Jun-92 Time: 16:02:22
File: DTA.31 DTA21
Operator: H. H. CADY
Plotted: 11-Sep-92 15:34:14

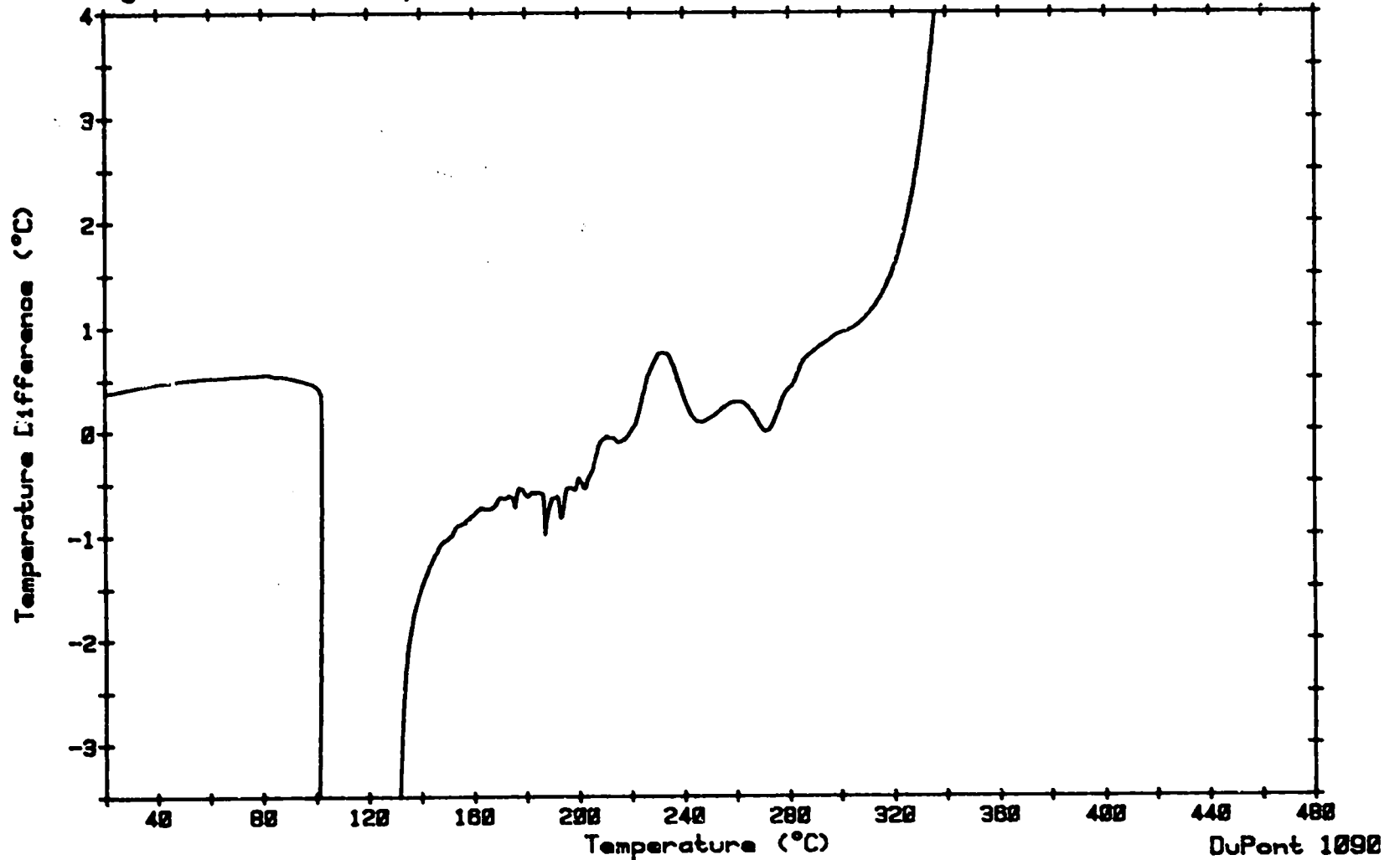

51

Figure A-5. INFARM2-REV-22, wet, macro, 5°C/min.

Sample: INFARM2-22 WET
Size: MACRO 0.0420 G
Rate: 5 DEG C/MIN
Program: Extended Playback V2.0

DTA

Date: 1-Jun-92 Time: 16:02:22
File: DTA.31 DTA21
Operator: H. H. CADY
Plotted: 11-Sep-92 15:26:03

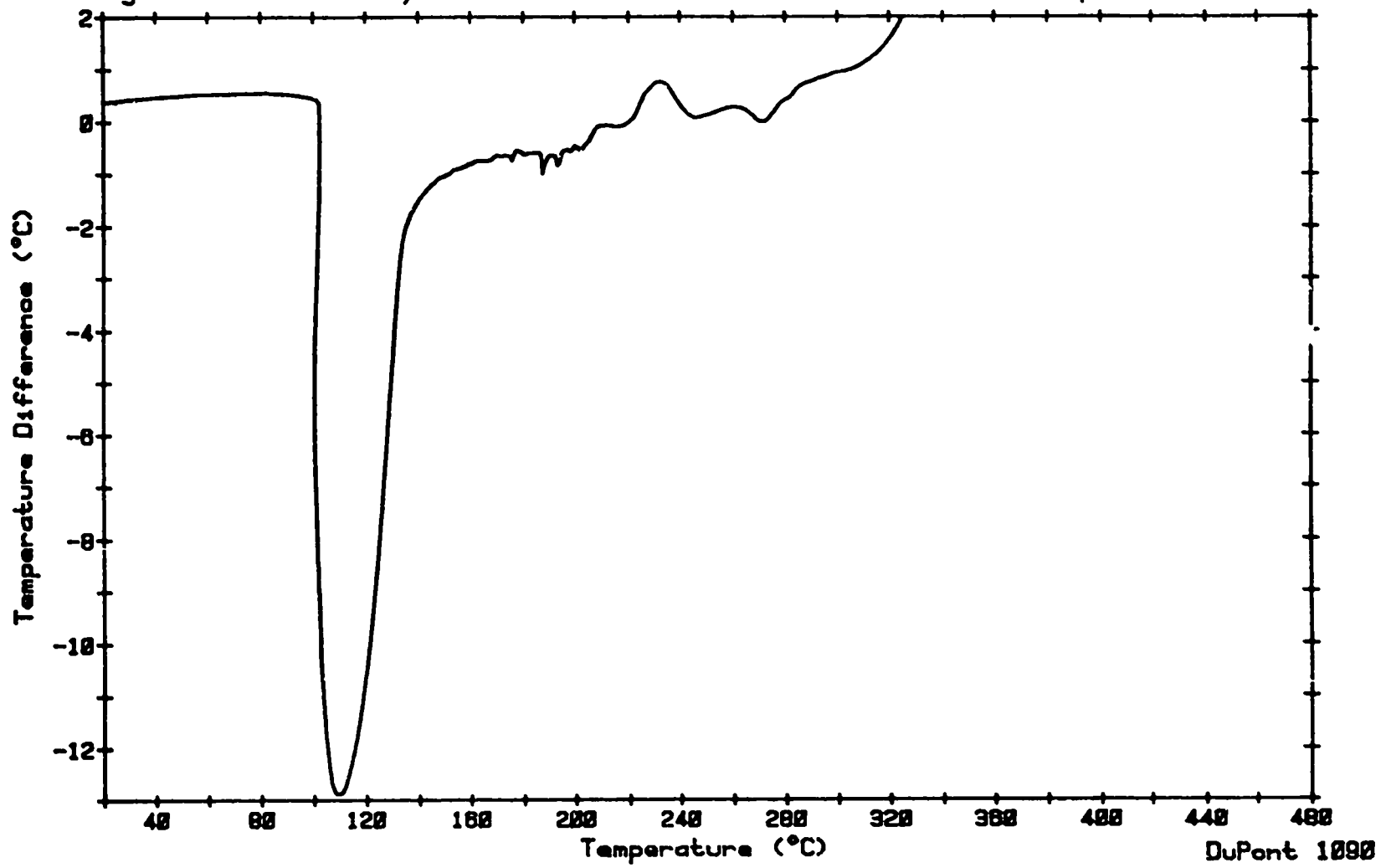

52

Figure A-6. INFARM2-REV-22, wet, macro, 5°C/min.

Sample: UPLANT2-10 DRYED
Size: MACRO 0.0180 G
Rate: 5 DEG C/MIN
Program: Extended Playback V2.0

DTA

Date: 8-Jun-92 Time: 12:16:36
File: DTA.37 DTA23
Operator: H. H. CADY
Plotted: 11-Sep-92 16:12:32

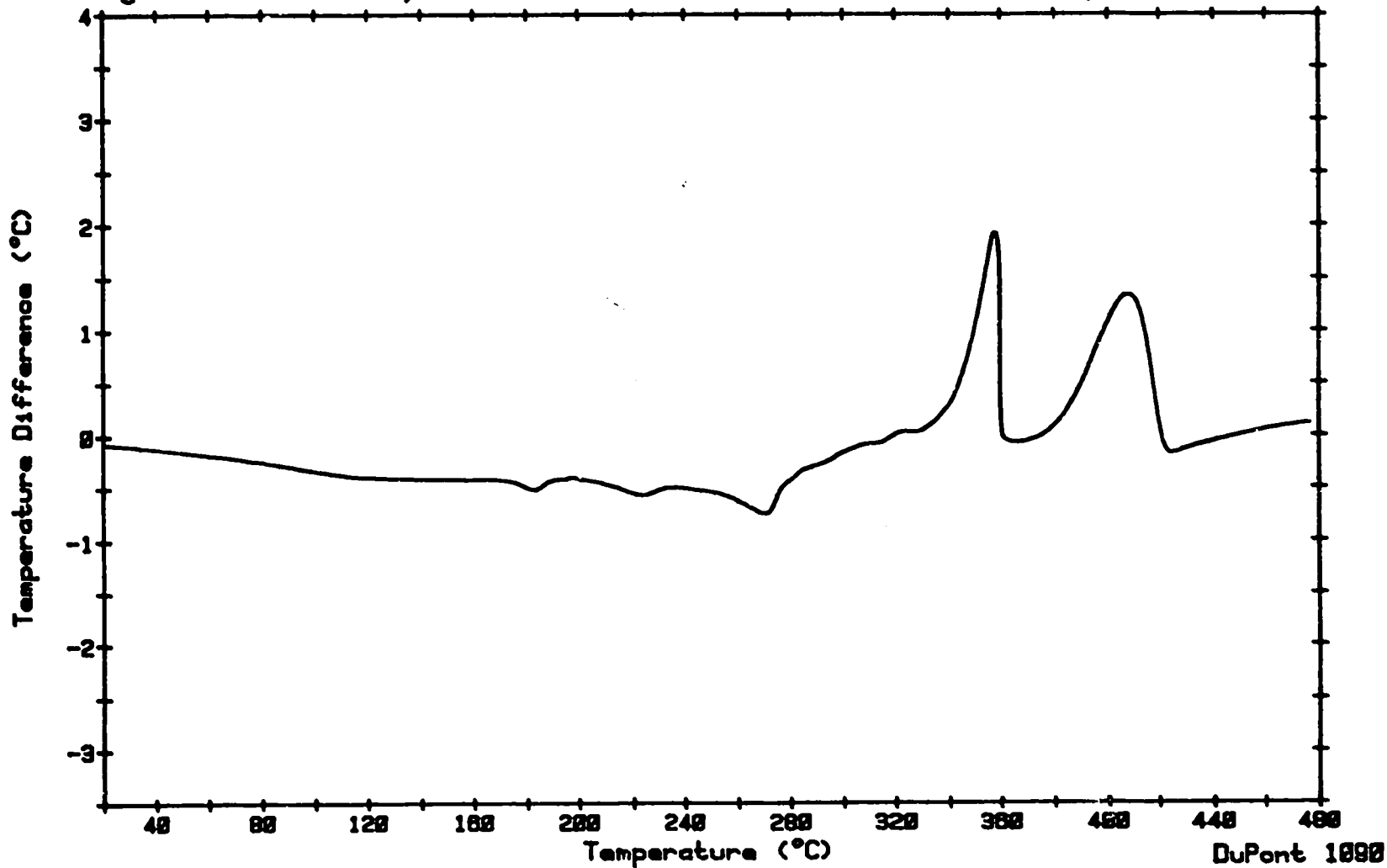

Figure A-7. UPLANT2-10, dry, macro, 5°C/min.

Sample: UPLANT2-10 WET
Size: MACRO 0.0535 G
Rate: 5
Program: Extended Playback V2.0

DTA

Date: 29-May-92 Times: 15:48:24
File: DTA.29 DTA21
Operator: H.H.CADY
Plotted: 29-May-92 17:54:24

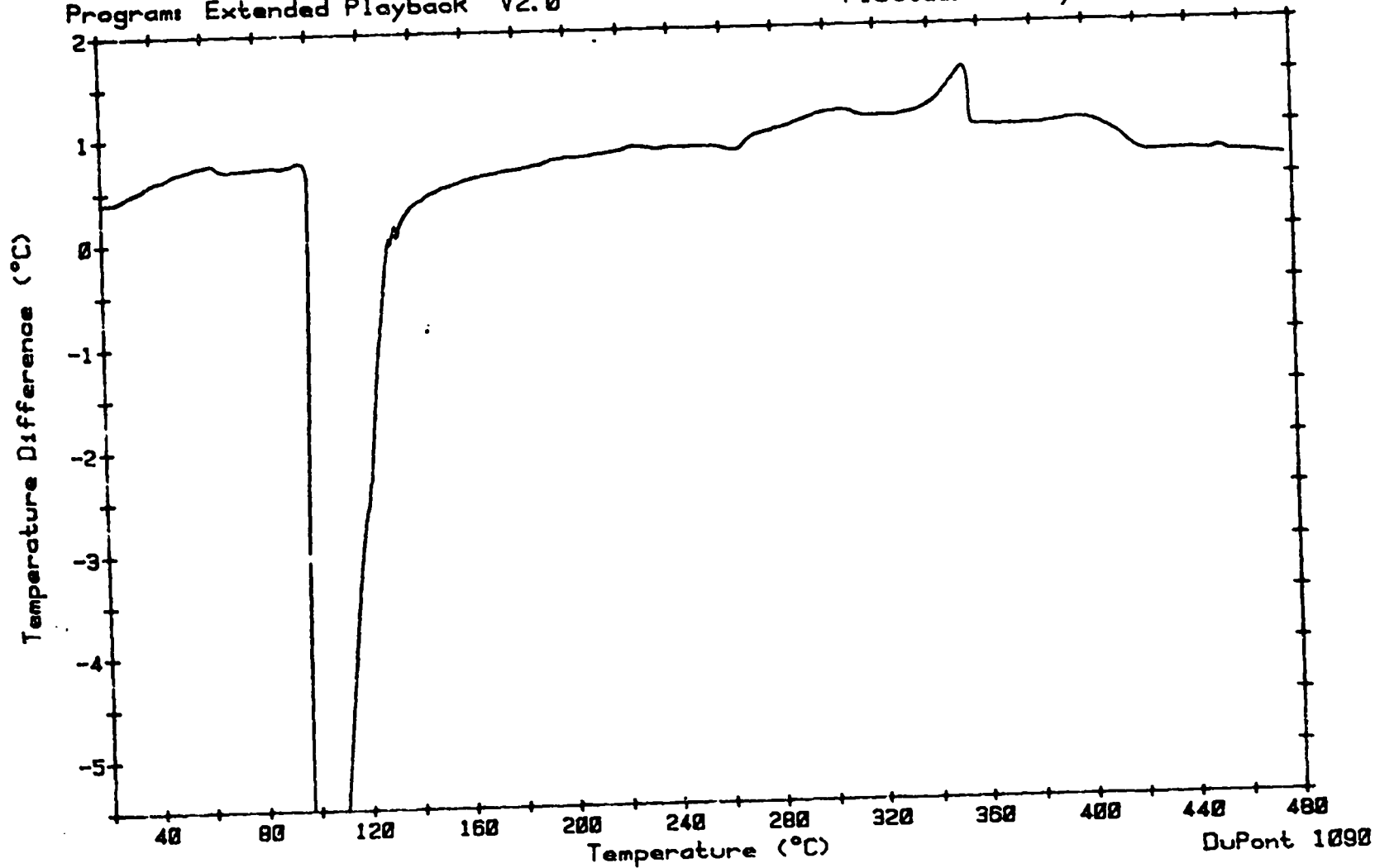
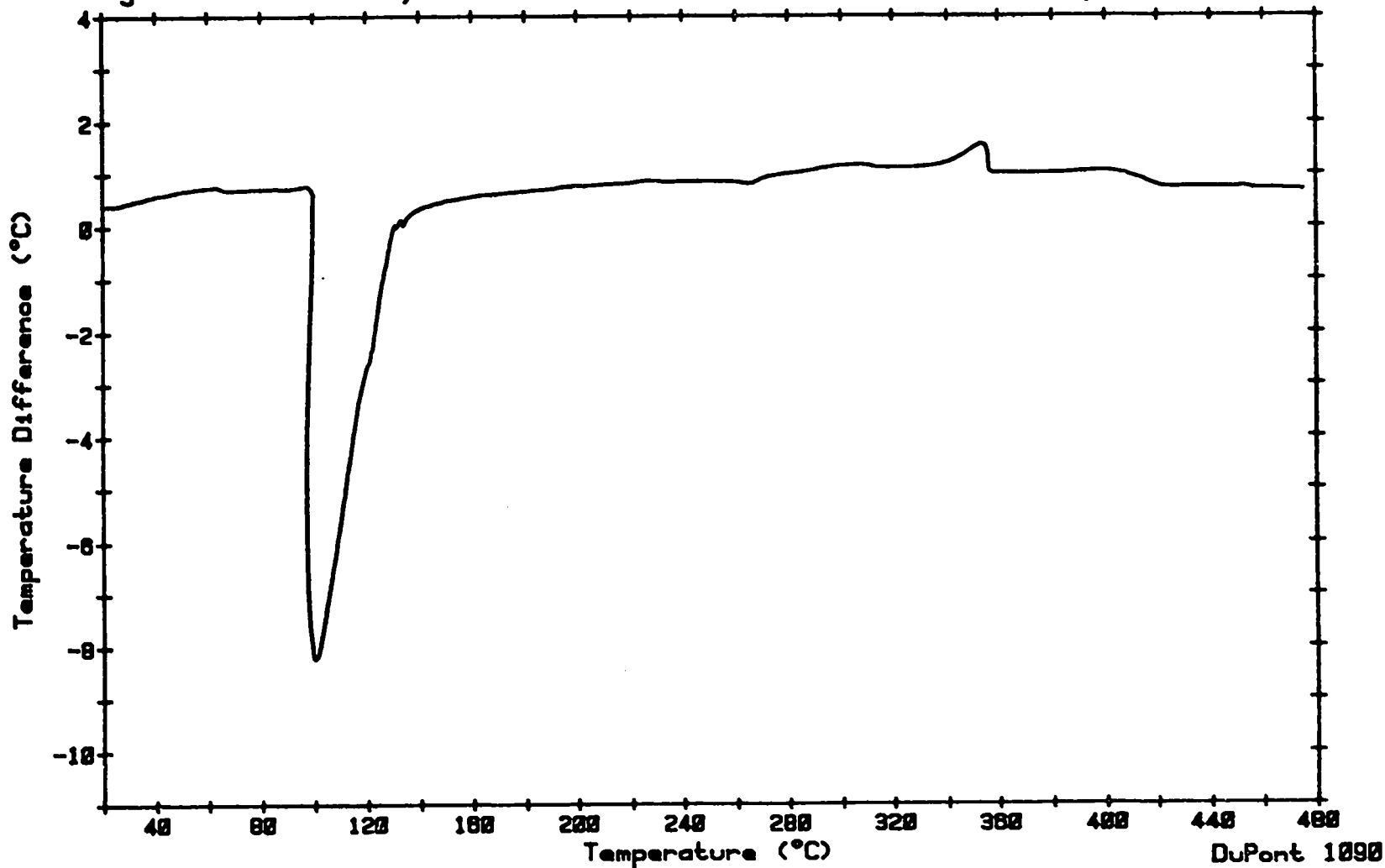

Figure A-8. UPLANT2-10, wet, macro, 5°C/min.

Sample: UPLANT2-10 WET
Size: MACRO 0.0535 G
Rate: 5
Program: Extended Playback V2.0

DTA

Date: 29-May-92 Time: 15:48:24
File: DTA.29 DTA21
Operator: H. H. CADY
Plotted: 27-Sep-92 11:49:17



SS

Figure A-9. UPLANT2-10, wet, macro, 5°C/min.

Sample: VENDOR MIX#1 AS REC
 Size: MACRO 0.0213 G
 Rate: 5 DEG C/MIN
 Program: Extended Playback V2.0

DTA

Date: 3-Jun-92 Time: 11:48:32
 File: DTA.35 DTA22
 Operator: H.H. CADY
 Plotted: 27-Sep-92 12:00:50

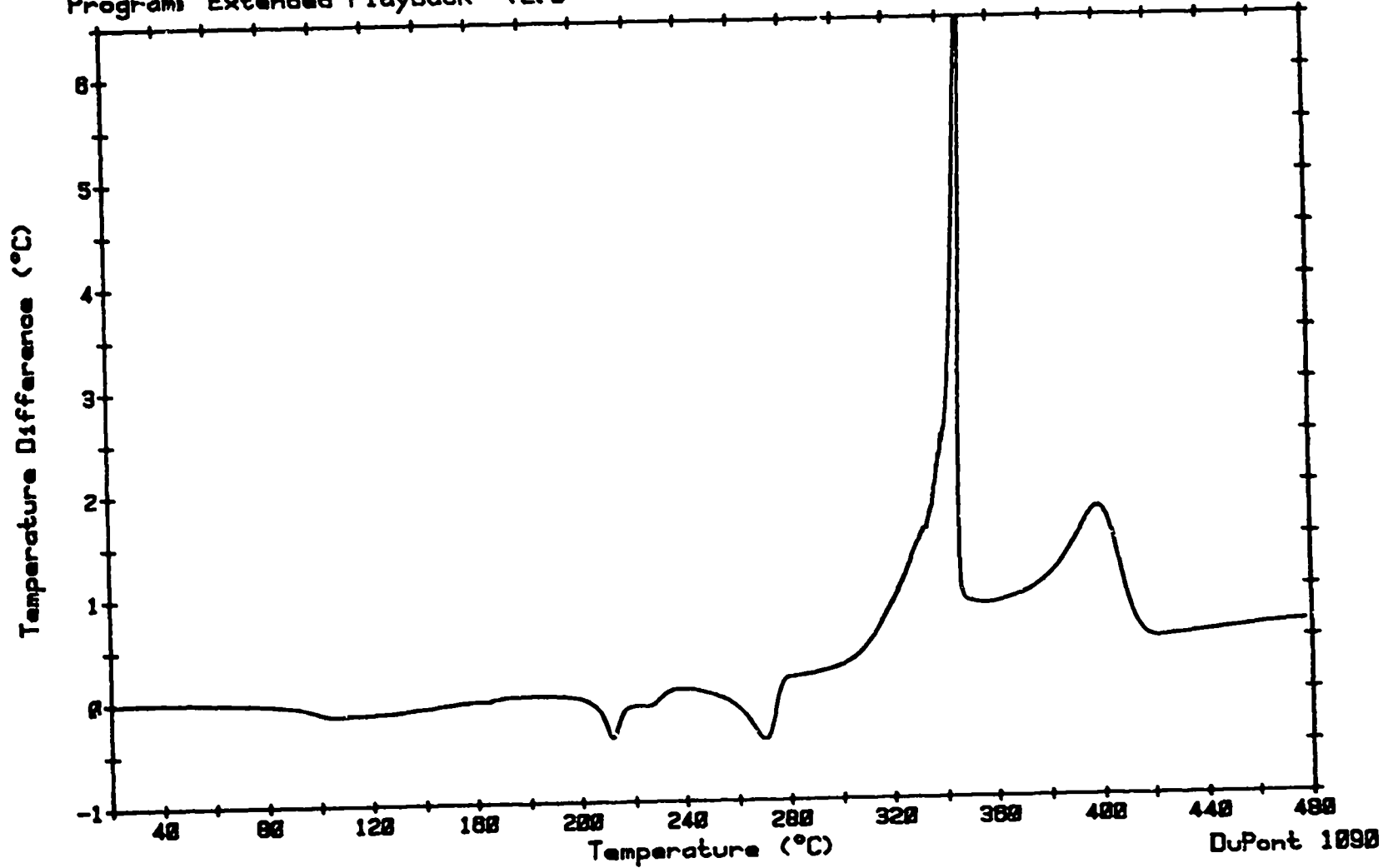

56

Figure A-10. VENDOR MIX#1, as received, macro, 5°C/min.

Sample: INFARM1-REV-23 DRY
Size: MICRO 0.0040 G
Rate: 20 DEG C/MIN
Program: Extended Playback V2.0

DTA

Date: 16-Jun-92 Times: 14:40:19
File: DTA.09 DTA24
Operator: H. H. CADY
Plotted: 23-Jun-92 9:59:15

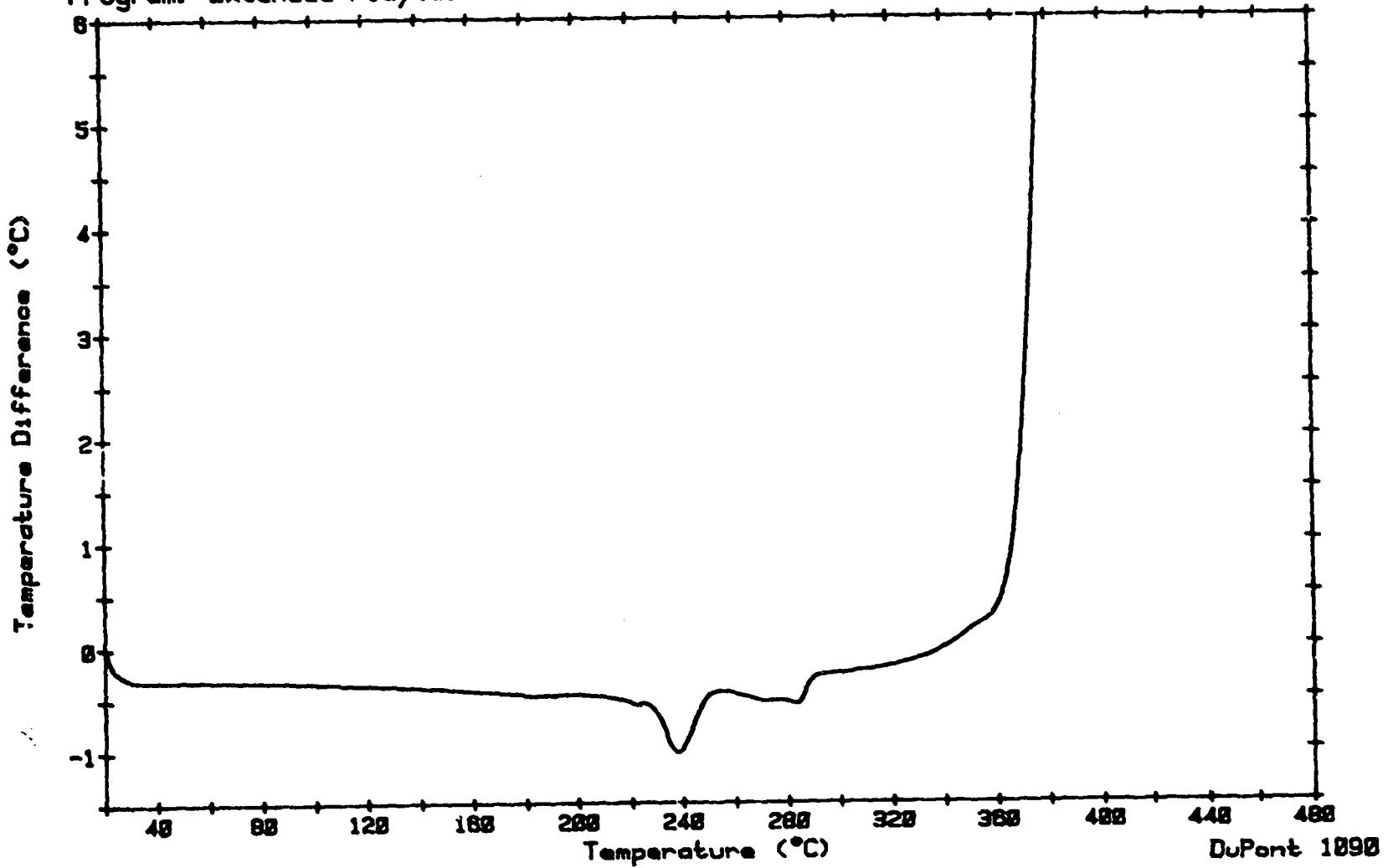

Figure A-11. INFARM1-REV-23, dry, micro, 20°C/min.

Sample: INFARM1-REV-23 DRY
Size: MICRO 0.0055 G
Rate: 10 DEG C/MIN
Program: Extended Playback V2.0

DTA

Date: 15-Jun-92 Time: 15:31:01
File: DTA.08 DTA24
Operator: H. H. CADY
Plotted: 23-Jun-92 10:38:27

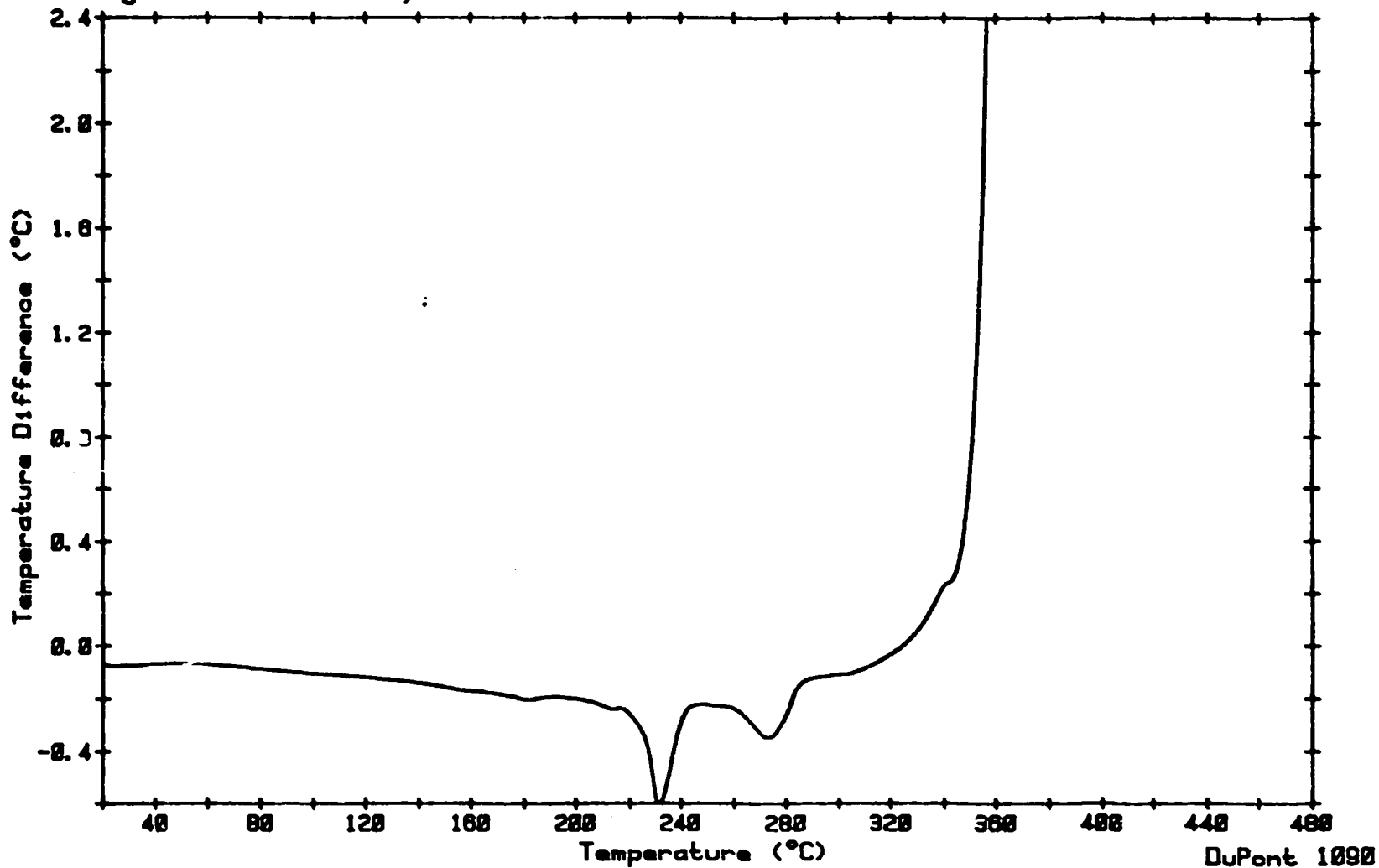
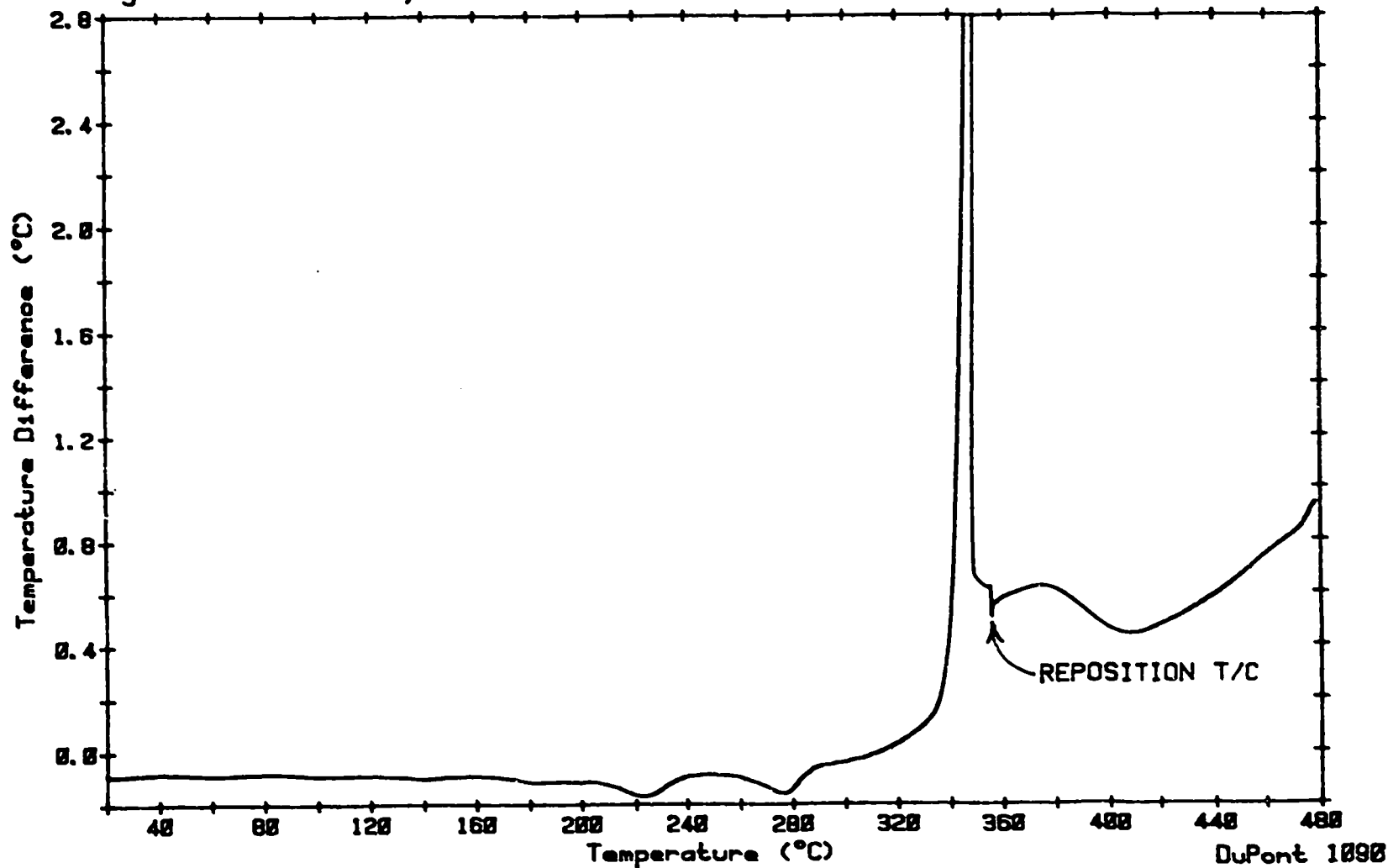

Figure A-12. INFARM1-REV-23, dry, micro, 10°C/min.

Sample: INFARM1-REV-23 DRY
Size: MICRO 0.0053 G
Rate: 5 DEG C/MIN
Program: Extended Playback V2.0

DTA

Date: 16-Jun-92 Time: 15:19:44
File: DTA.10 DTA24
Operator: H.H. CADY
Plotted: 19-Jun-92 10:44:51



65

Figure A-13. INFARM1-REV-23, dry, micro, 5°C/min.

Sample: INFARM1-REV-23 DRY
Size: MICRO 0.0030 G
Rate: 2 DEG C/MIN
Program: Extended Playback V2.0

DTA

Date: 18-Jun-92 Time: 10:51:49
File: DTA.14 DTA25
Operator: H.H. CADY
Plotted: 19-Jun-92 9:18:29

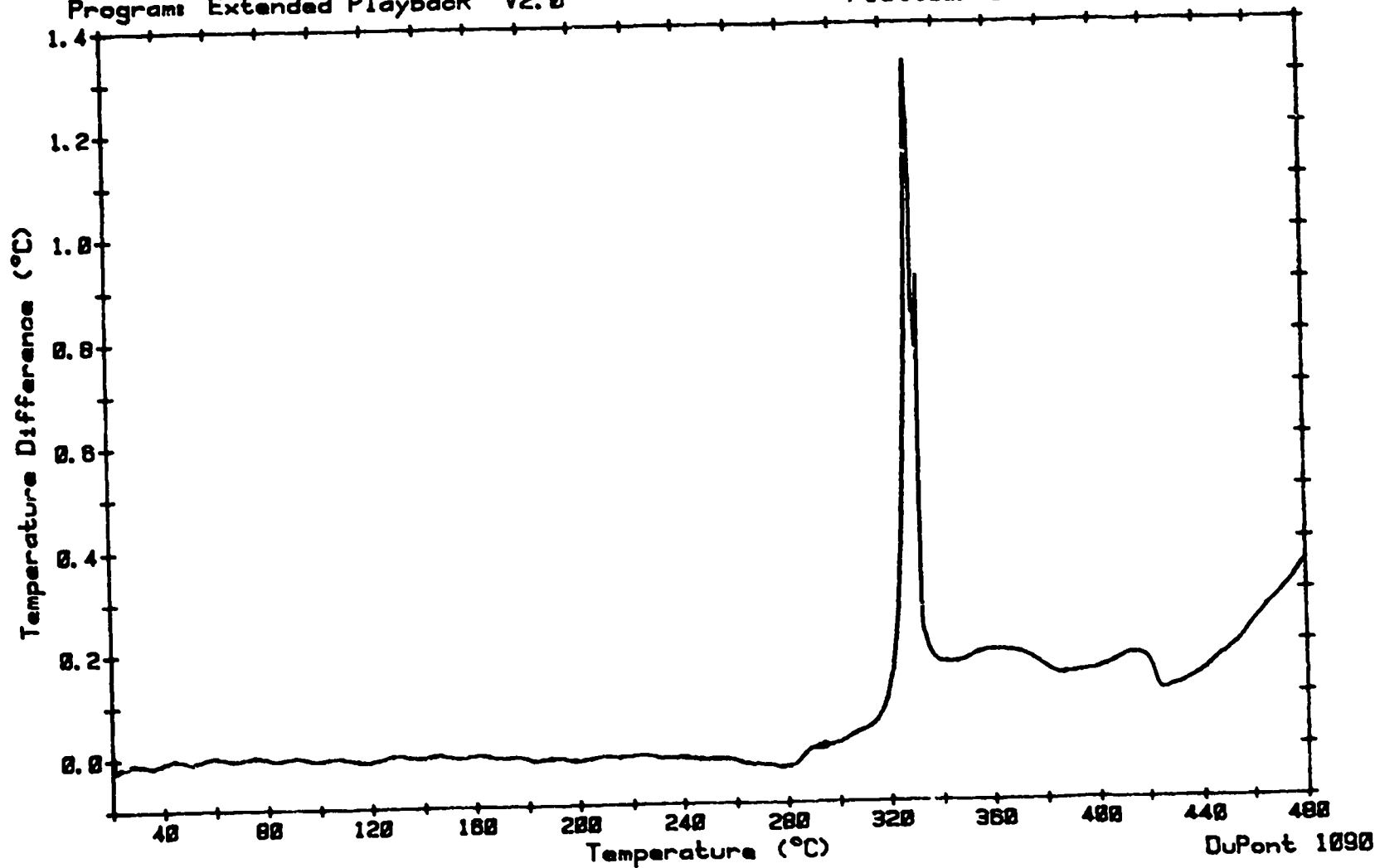

Figure A-14. INFARM1-REV-23, dry, micro, 2°C/min.

Sample: INFARM2-REV-22 DRY
Size: MICRO 0.0065 G
Rate: 10 DEG C/MIN
Program: Extended Playback V2.0

DTA

Date: 15-Jun-92 Time: 14:35:00
File: DTA.07 DTA24
Operator: H.H.CADY
Plotted: 27-Sep-92 12:09:25

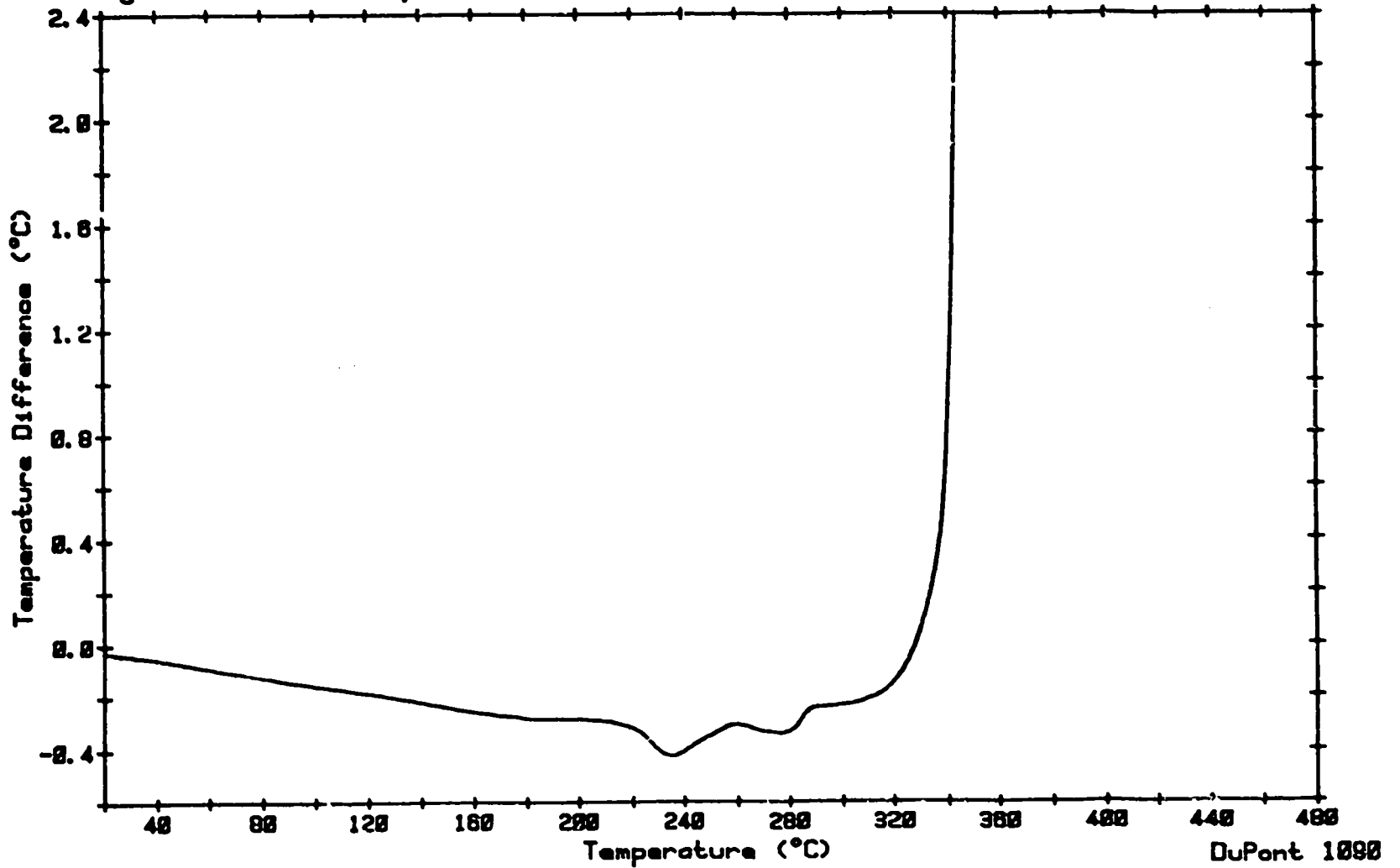

Figure A-15. INFARM2-REV-22, dry, micro, 10°C/min.

Sample: INFARM2-REV-22 DRY
Size: MICRO 0.0059 G
Rate: 5 DEG C/MIN
Program: Extended Playback V2.0

DTA

Date: 25-Jun-92 Time: 10:47:48
File: DTA.15 DTA27
Operator: H.H.CADY
Plotted: 25-Jun-92 13:26:41

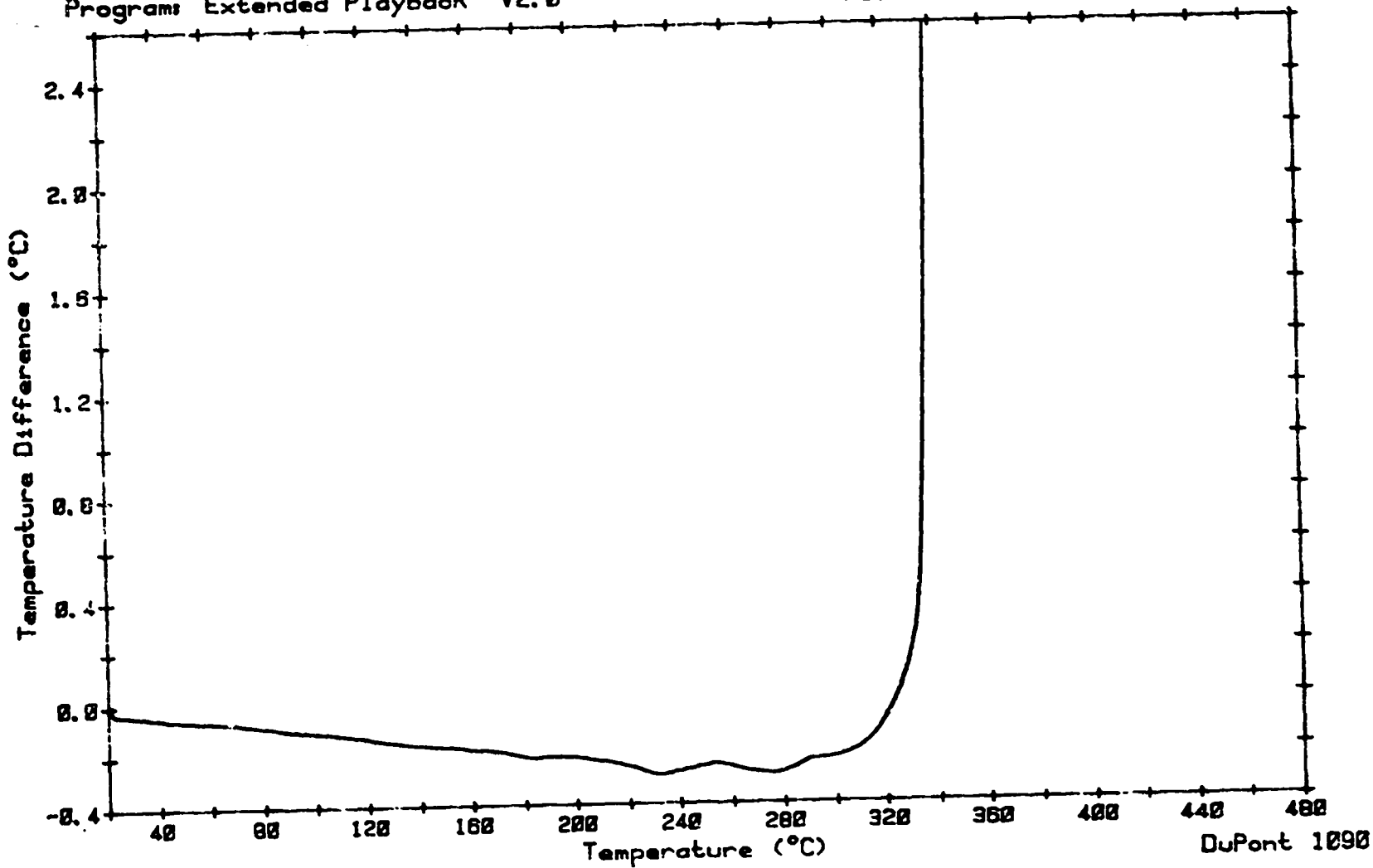

Figure A-16. INFARM2-REV-22, dry, micro, 5°C/min.

Sample: UPLANT2-10 DRY
Size: MICRO
Rate: 10 DEG C/MIN
Program: Extended Playback V2.0

DTA

Date: 24-JUN-92 Time: 13:33:48
File: DTA.03 DTA24
Operator: H. H. CADY
Plotted: 24-JUN-92 11:59:55

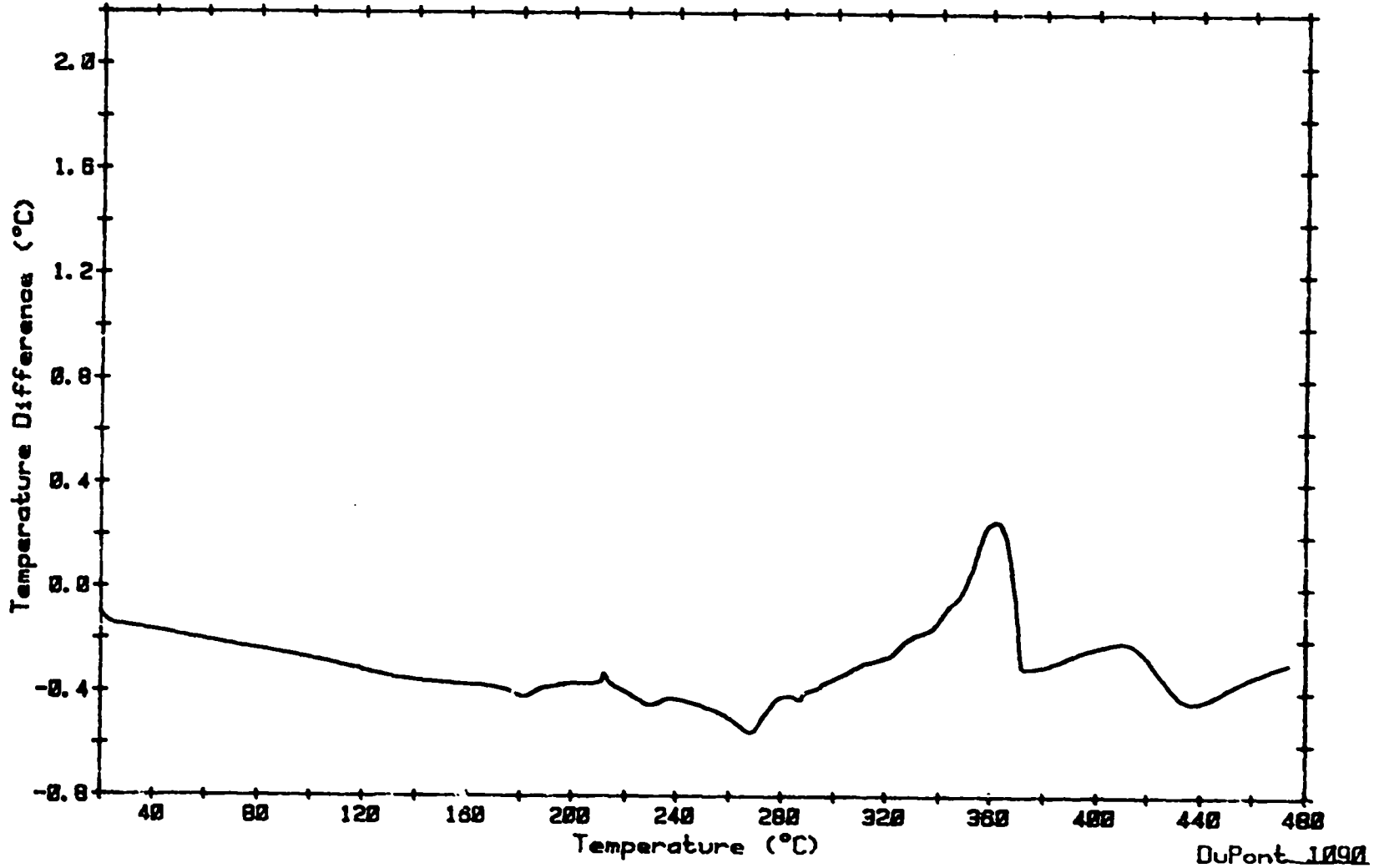
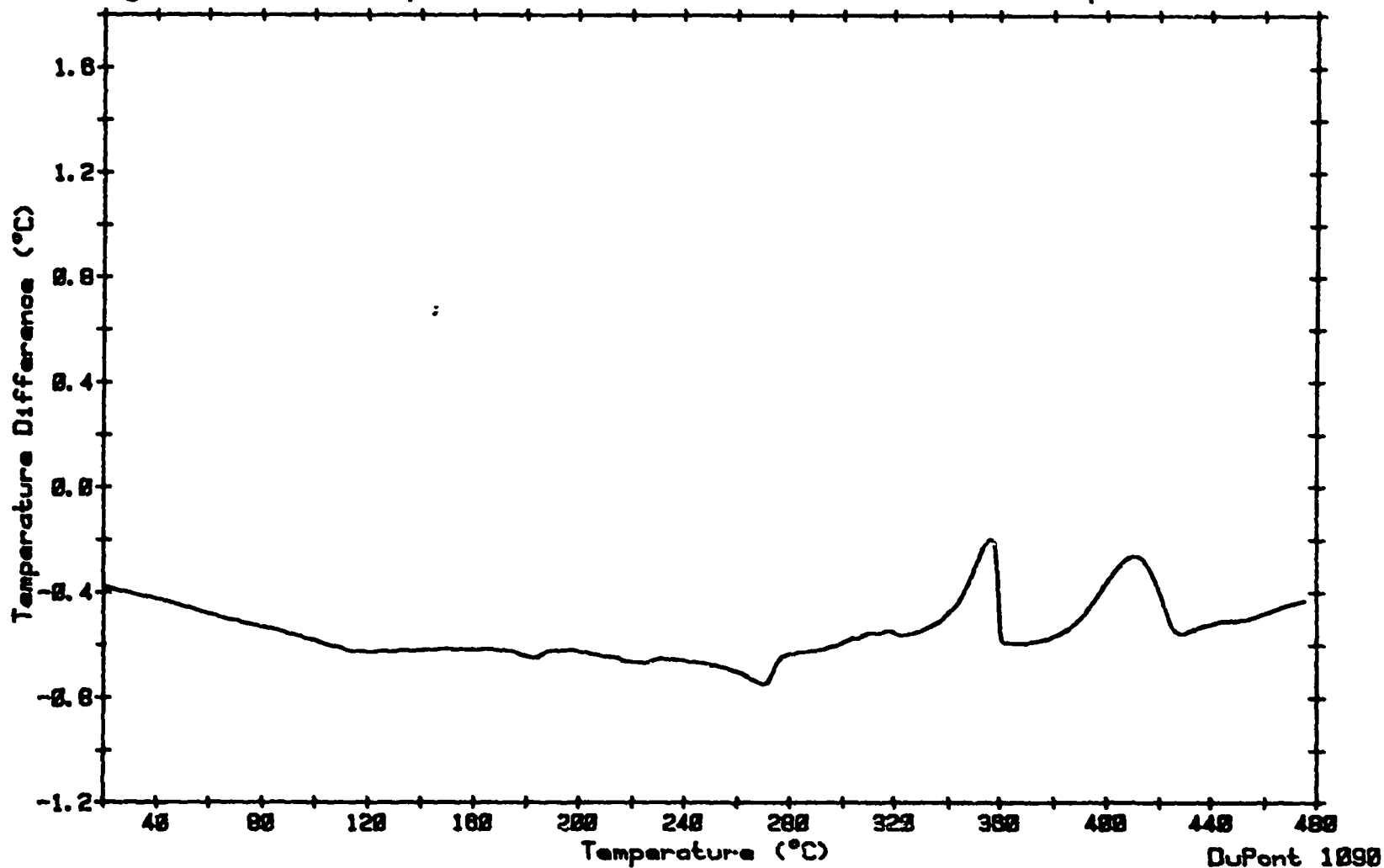

Figure A-17. UPLANT2-10, dry, micro, 10°C/min.

Sample: UPLANT2-10 DRY
 Size: MICRO 0.0029 G
 Rate: 5 DEG C/MIN
 Program: Extended Playback V2.0

DTA

Date: 9-Jun-92 Time: 15:12:28
 File: DTA.39 DTA23
 Operator: H.H. CADY
 Plotted: 27-Sep-92 12:20:10



64

Figure A-18. UPLANT2-10, dry, micro, 5°C/min.

Sample: VENDOR MIX #1 AS RECEIV
Size: MICRO 0.0058 G
Rate: 10 DEG C/MIN
Program: Extended Playback V2.0

DTA

Date: 12-Jun-92 Times 15:19:30
File: DTA.04 DTA24
Operator: H. H. CADY
Plotted: 24-Jun-92 11:32:03

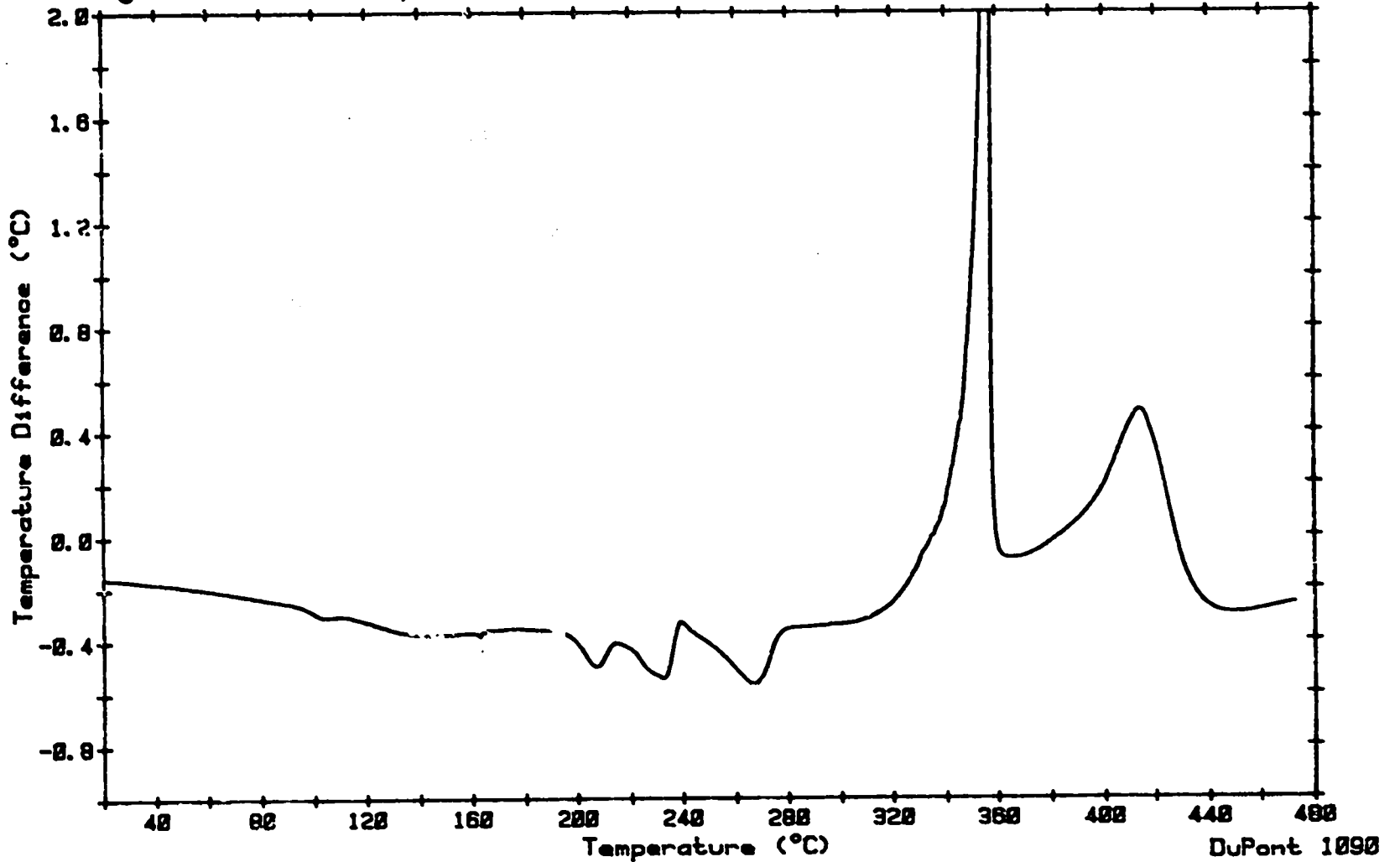

Figure A-19. VENDOR MIX#1, as received, micro, 10°C/min.

Sample: VENDOR MIX #1
Size: MICRO 0.0049 G
Rate: 5 DEG C/MIN
Program: Extended Playback V2.0

DTA

Date: 10-Jun-92 Time: 9:14:23
File: DTA.40 DTA23
Operator: H.H.CADY
Plotted: 24-Jun-92 17:21:18

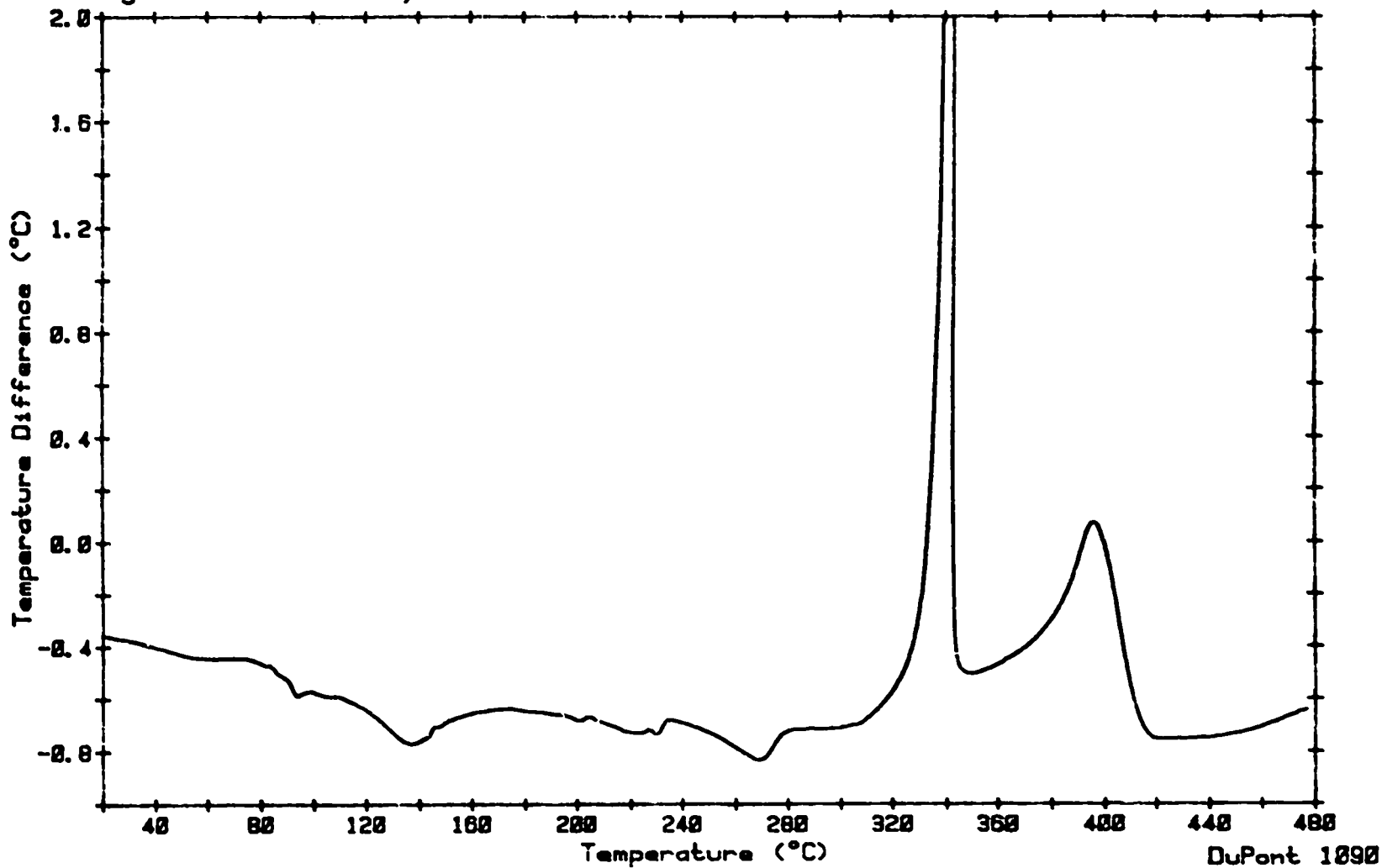
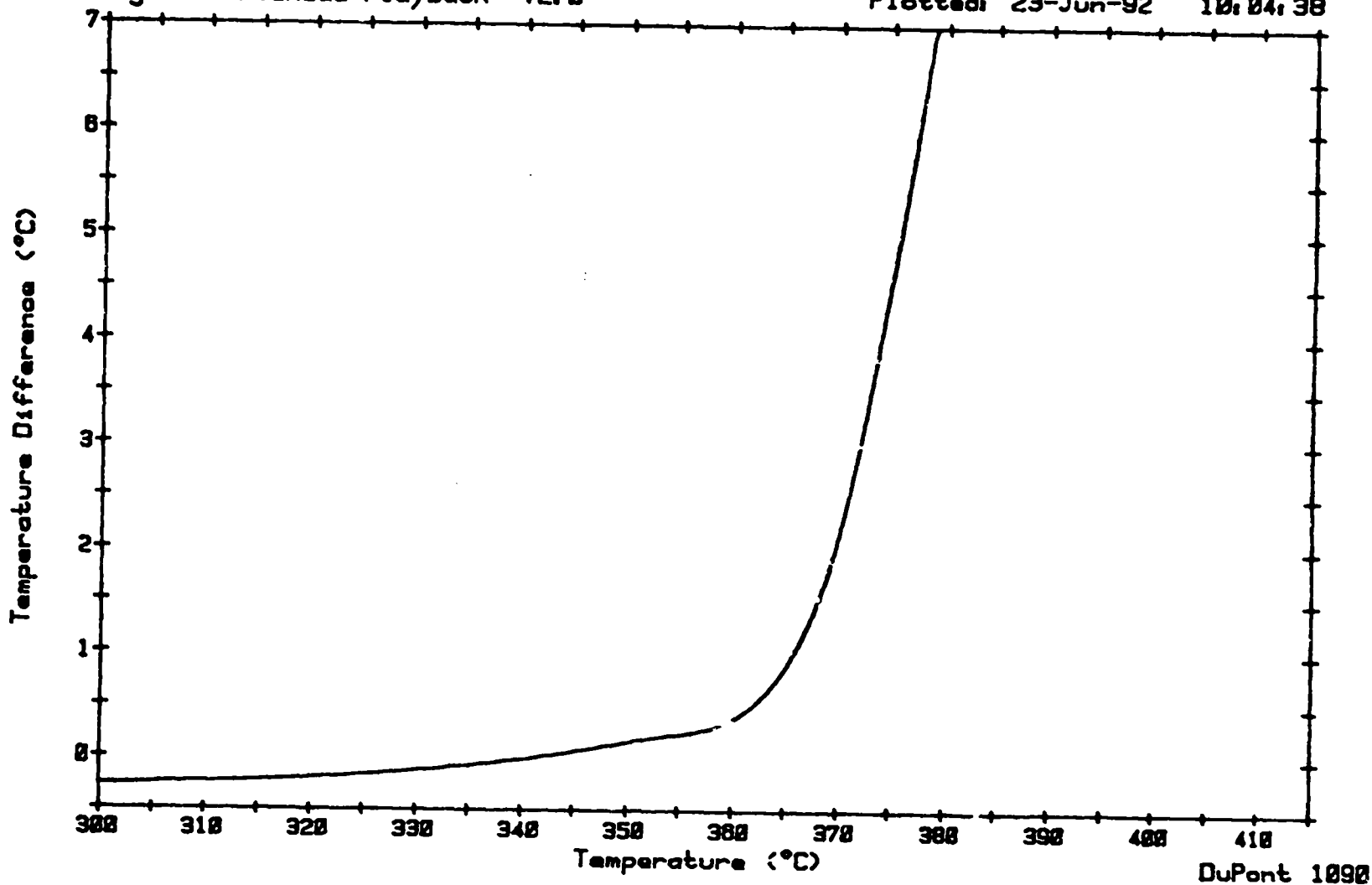

Figure A-20. VENDOR MIX#1, as received, micro, 5°C/min.

Sample: INFARM1-REV-23 DRY
Size: MICRO 0.0040 G
Rate: 20 DEG C/MIN
Program: Extended Playback V2.0

DTA

Date: 16-Jun-92 Time: 14:40:19
File: DTA.09 DTA24
Operator: H. H. CADY
Plotted: 23-Jun-92 10:04:38



DuPont 1090

Figure A-21. INFARM1-REV-23, dry, micro, 20°C/min.

Sample: INFARM1-REV-23 DRY
Size: MICRO 0.0055 G
Rate: 10 DEG C/MIN
Program: Extended Playback V2.0

DTA

Date: 15-Jun-92 Time: 15:31:01
File: DTA.08 DTA24
Operator: H. H. CADY
Plotted: 23-Jun-92 10:54:40

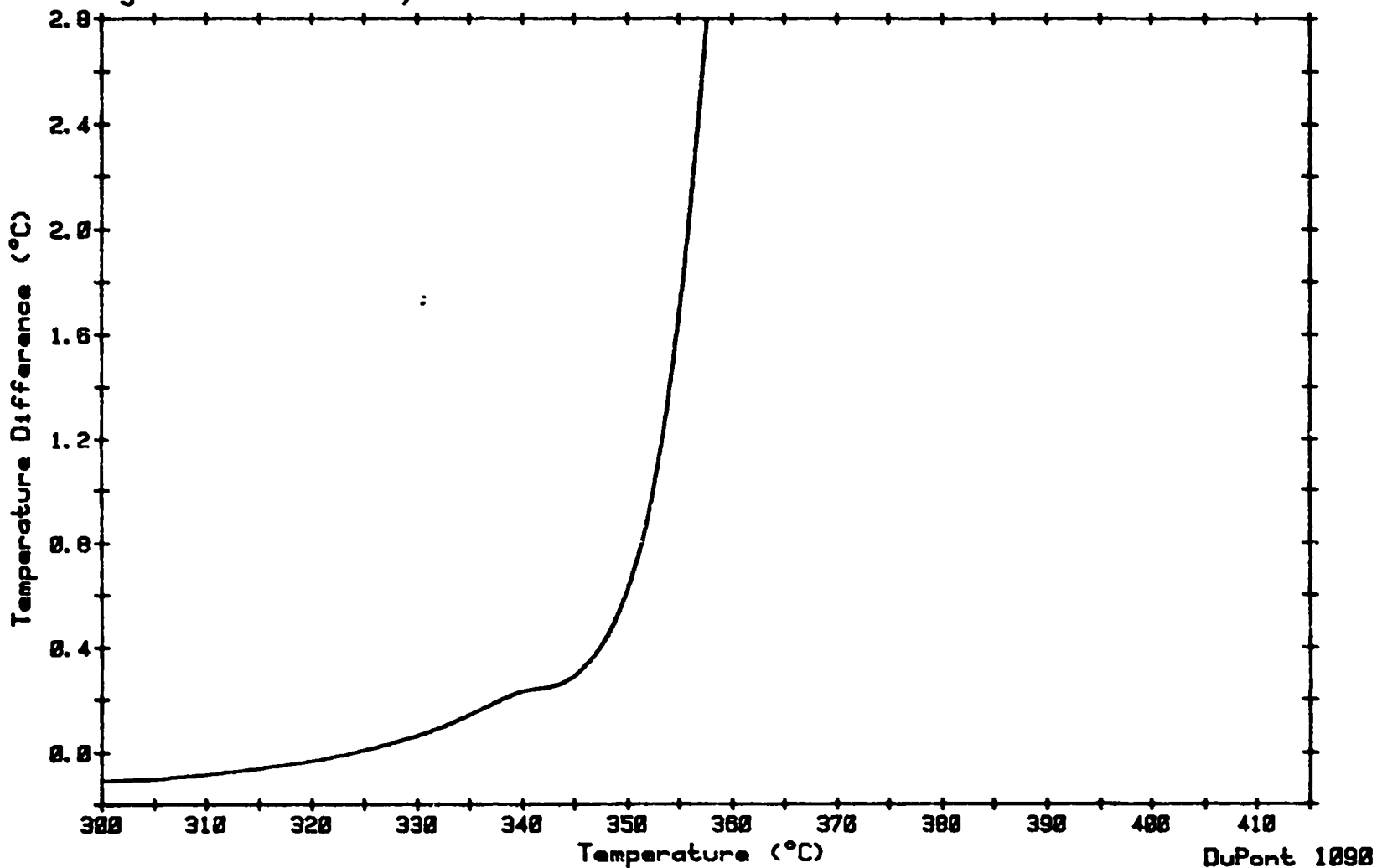
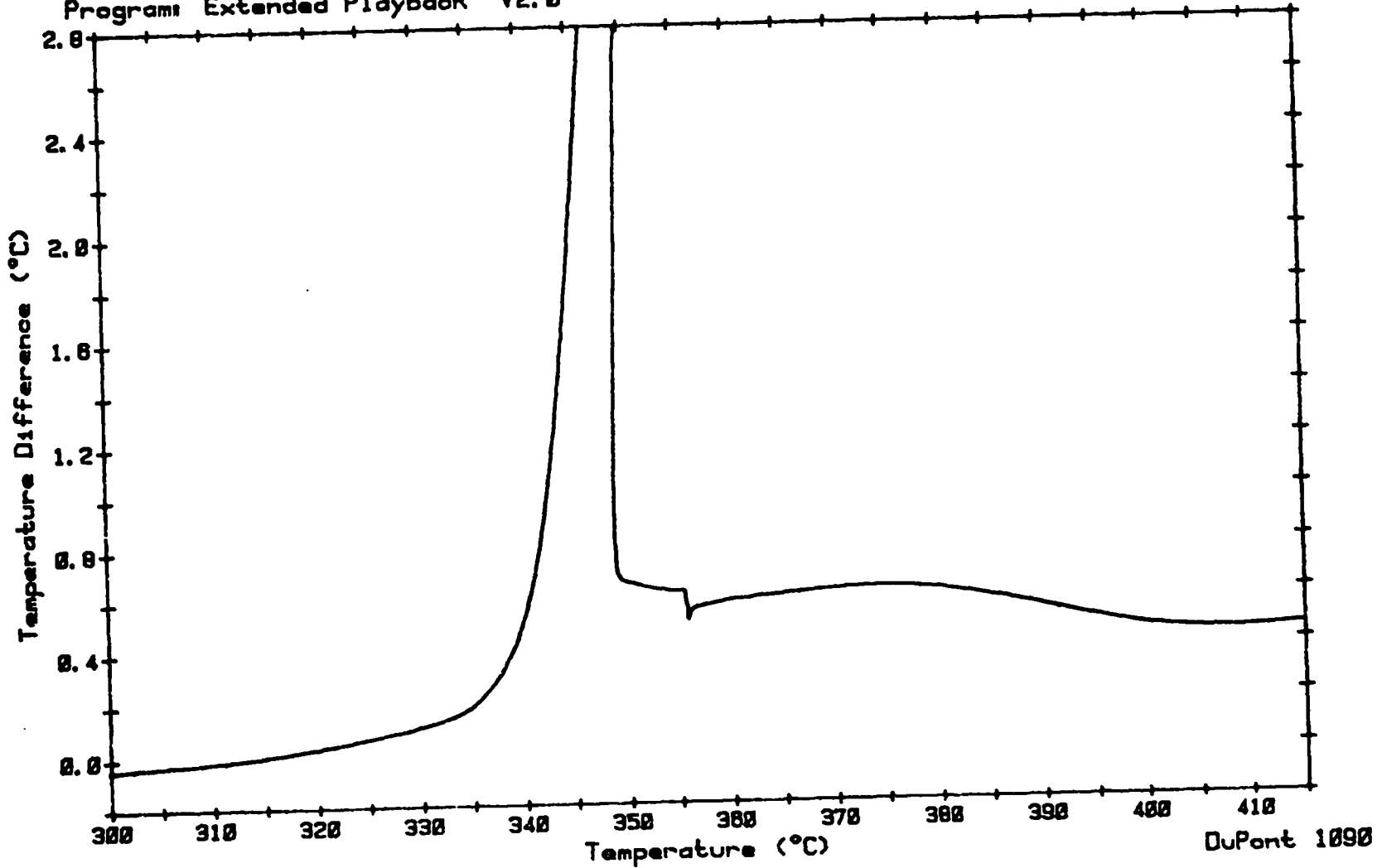

Figure A-22. INFARM1-REV-23, dry, micro, 10°C/min.

Sample: INFARM1-REV-23 DRY
Size: MICRO 0.0053 G
Rate: 5 DEG C/MIN
Program: Extended Playback V2.0

Date: 18-Jun-92 Time: 15:19:44
File: DTA.10 DTA24
Operator: H. H. CADY
Plotted: 19-Jun-92 11:06:16

DTA



69

Figure A-23. INFARM1-REV-23, dry, micro, 5°C/min.

Sample: INFARM1-REV-23 DRY
Size: MICRO 0.0030 G
Rate: 2 DEG C/MIN
Program: Extended Playback V2.0

DTA

Date: 18-Jun-92 Time: 10:51:49
File: DTA.14 DTA25
Operator: H.H. CADY
Plotted: 19-Jun-92 9:36:39

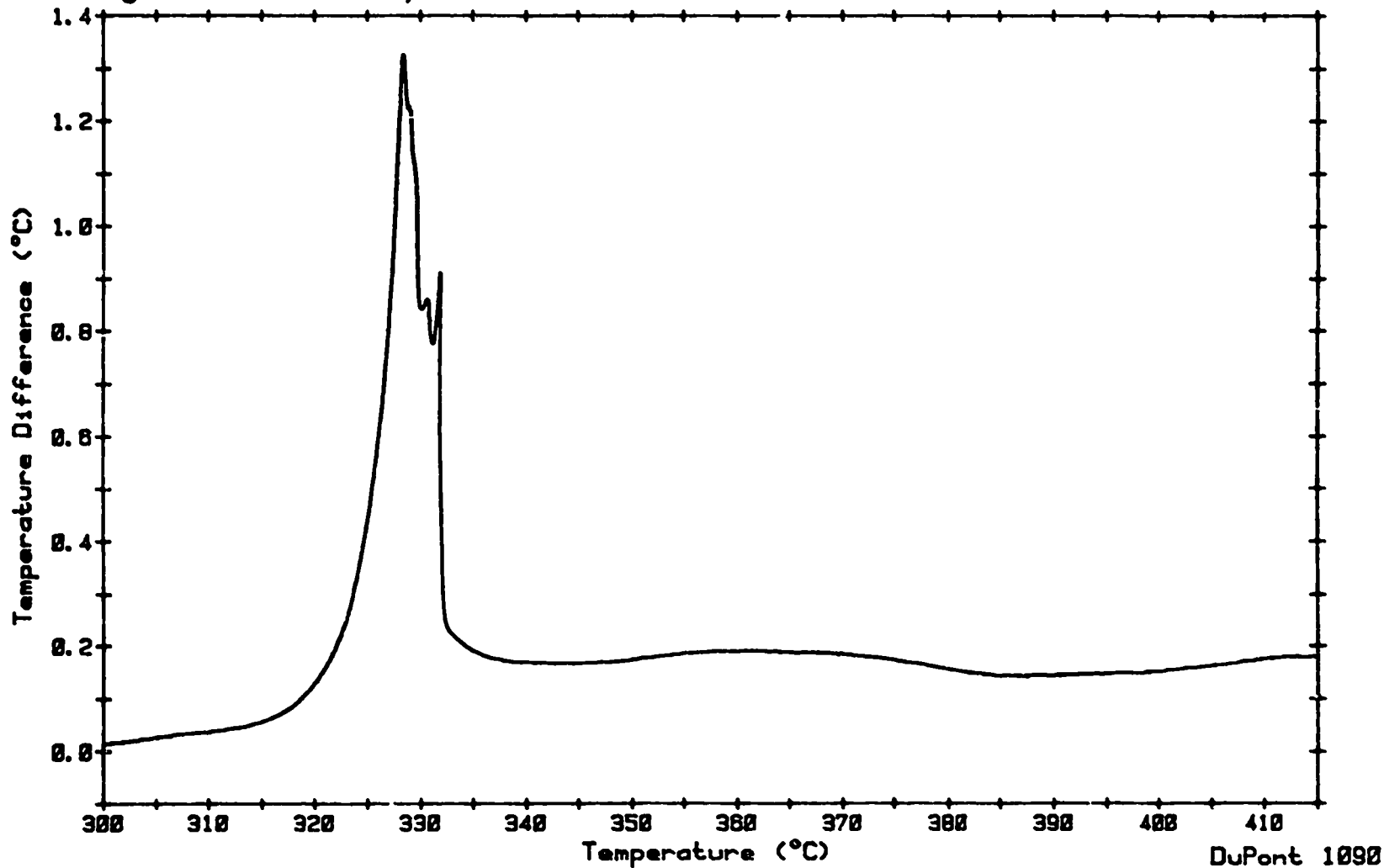

Figure A-24. INFARM1-REV-23, dry, micro, 2°C/min.

Sample: INFARM2-REV-22 DRY
Size: MICRO 0.0065 G
Rate: 10 DEG C/MIN
Program: Extended Playback V2.0

DTA

Date: 15-Jun-92 Time: 14:35:00
File: DTA.07 DTA26
Operator: H. H. CADY
Plotted: 23-Jun-92 17:01:03

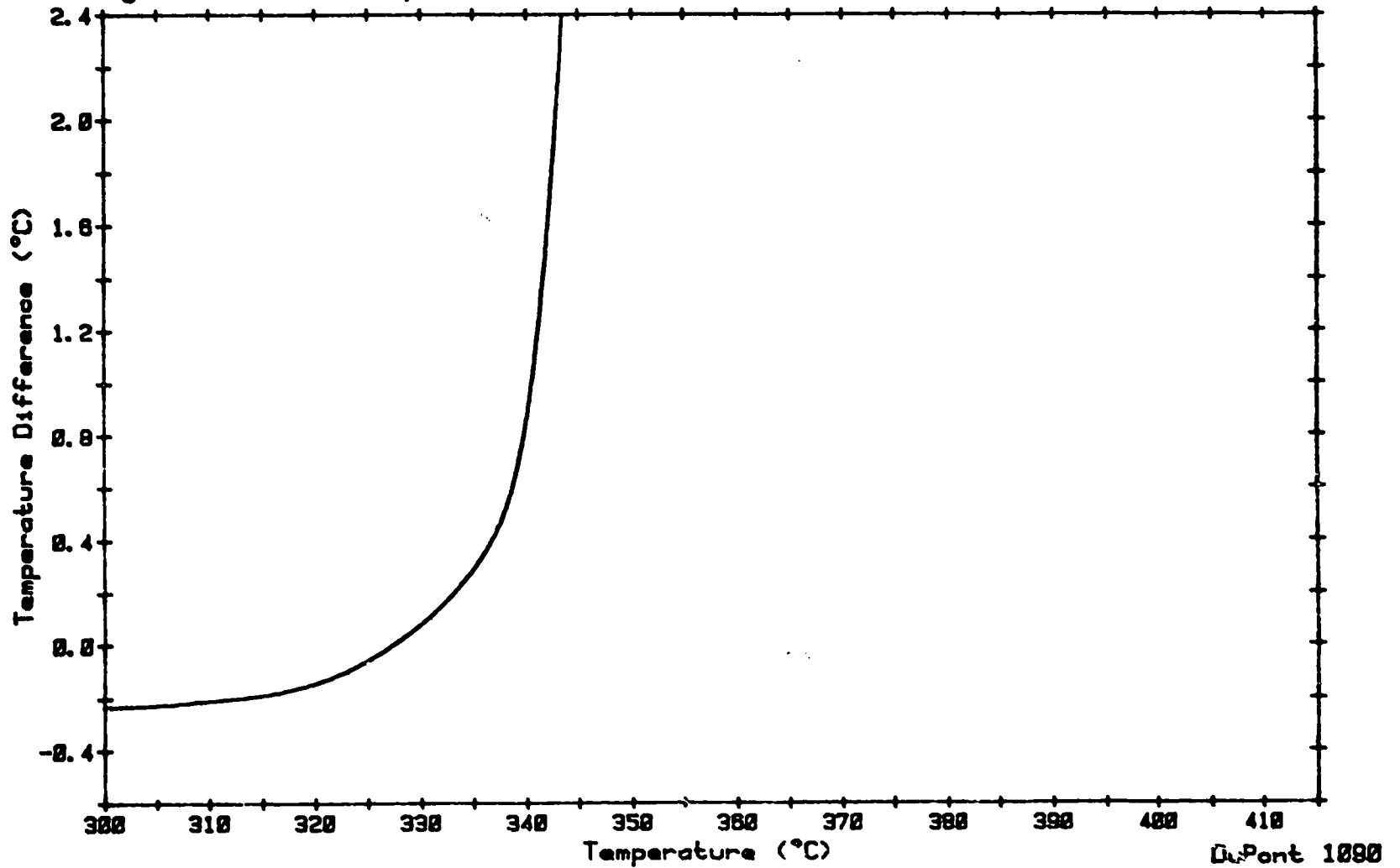

Figure A-25. INFARM2-REV-22, dry, micro, 10°C/min.

Sample: INFARM2-REV-22 DRY
Size: MICRO 0.0059 G
Rate: 5 DEG C/MIN
Program: Extended Playback V2.0

DTA

Date: 25-Jun-92 Time: 10:47:48
File: DTA.15 DTA27
Operator: H.H. CADY
Plotted: 25-Jun-92 16:59:03

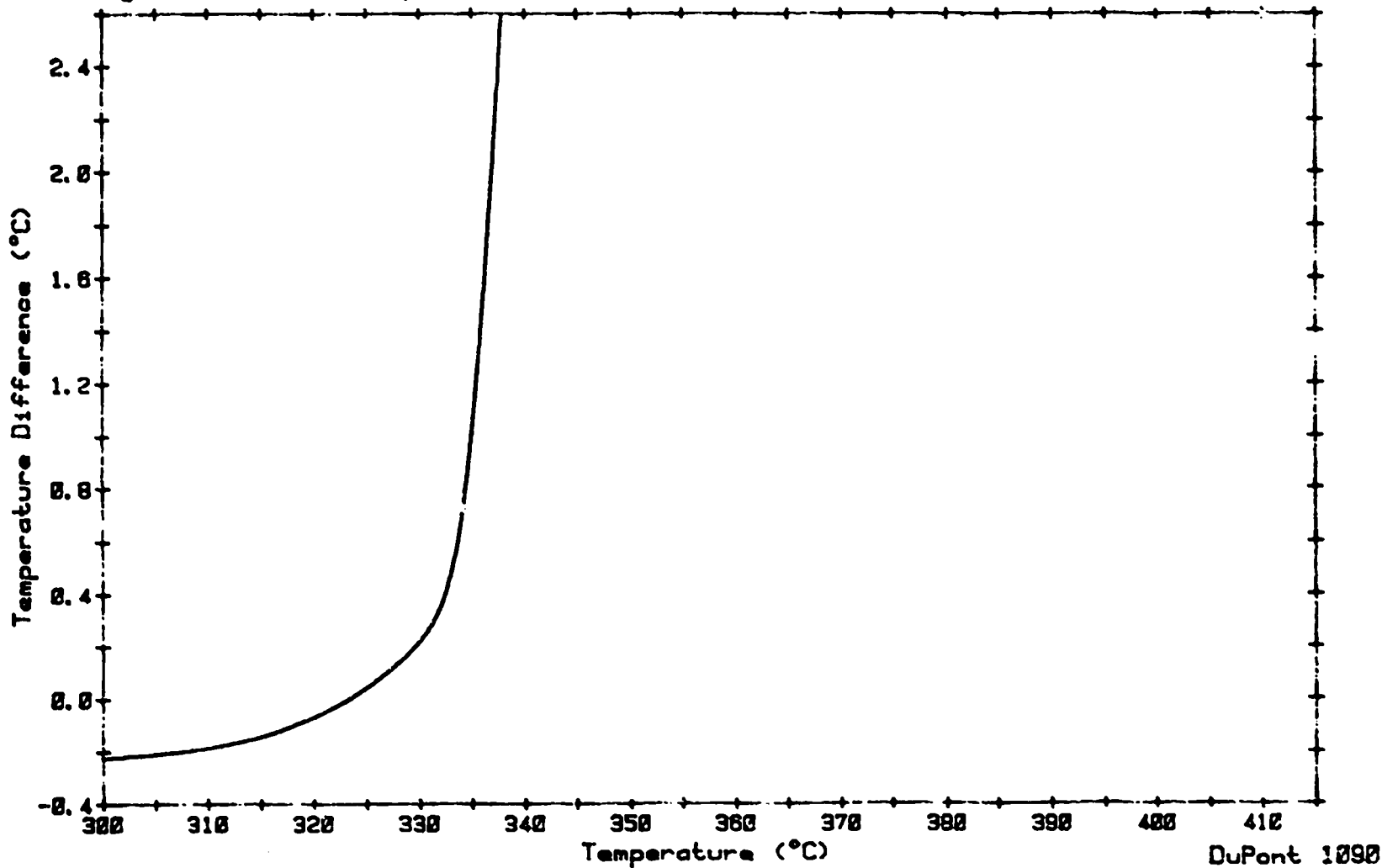

Figure A-26. INFARM2-REV-22, dry, micro, 5°C/min.

Sample: UPLANT2-10 DRY
Size: MICRO
Rate: 10 DEG C/MIN
Program: Extended Playback V2.0

DTA

Date: 12-Jun-92 Time: 13:33:48
File: DTA.03 DTA24
Operator: H.H. CADY
Plotted: 24-Jun-92 13:31:04

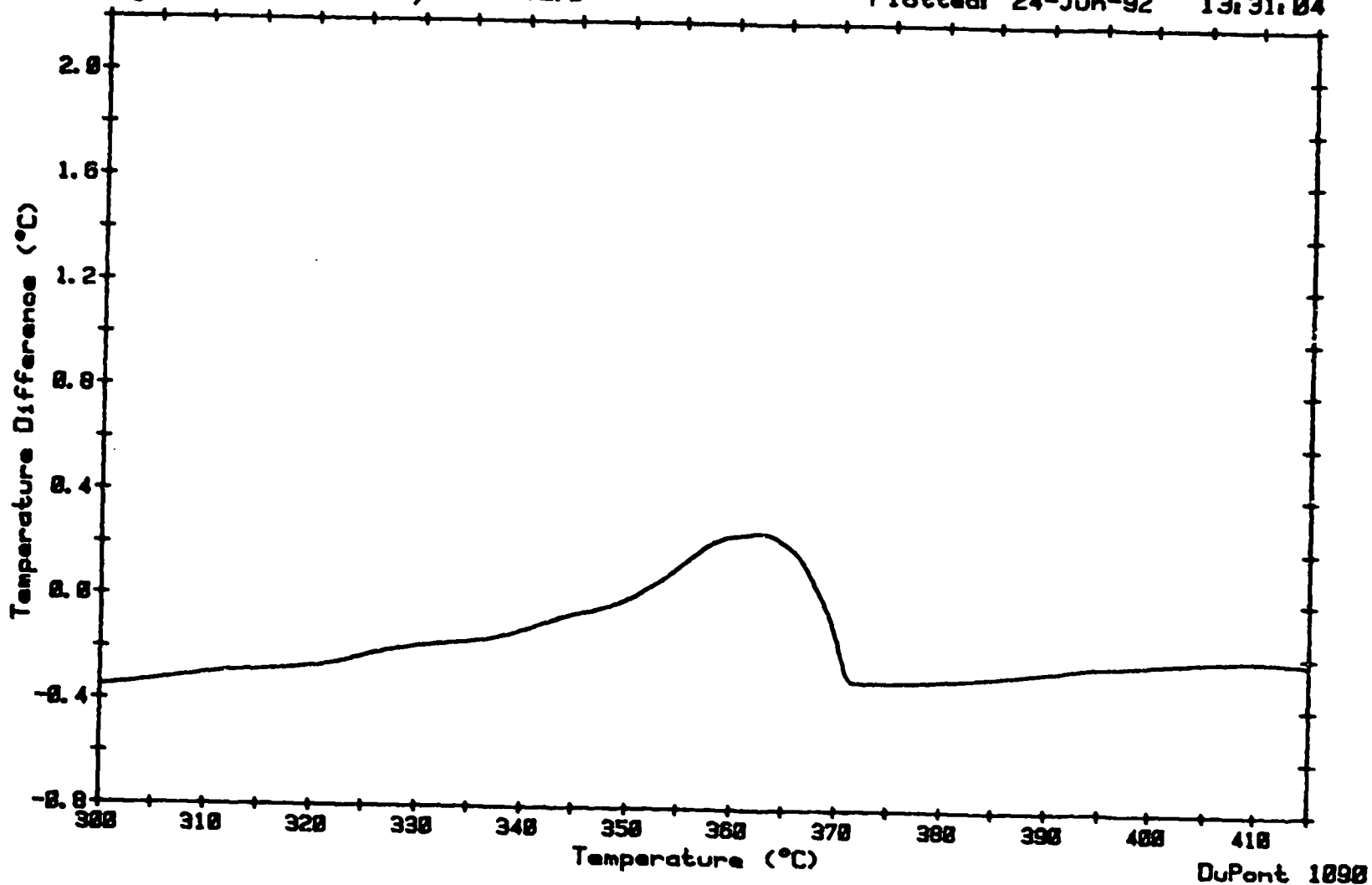

Figure A-27. UPLANT2-10, dry, micro, 10°C/min.

Sample: UPLANT2-10 DRY
Size: MICRO 0.0029 G
Rate: 5 DEG C/MIN
Program: Extended Playback V2.0

DTA

Date: 9-Jun-92 Time: 15:12:26
File: DTA.39 DTA23
Operator: H. H. CADY
Plotted: 27-Sep-92 12:29:08

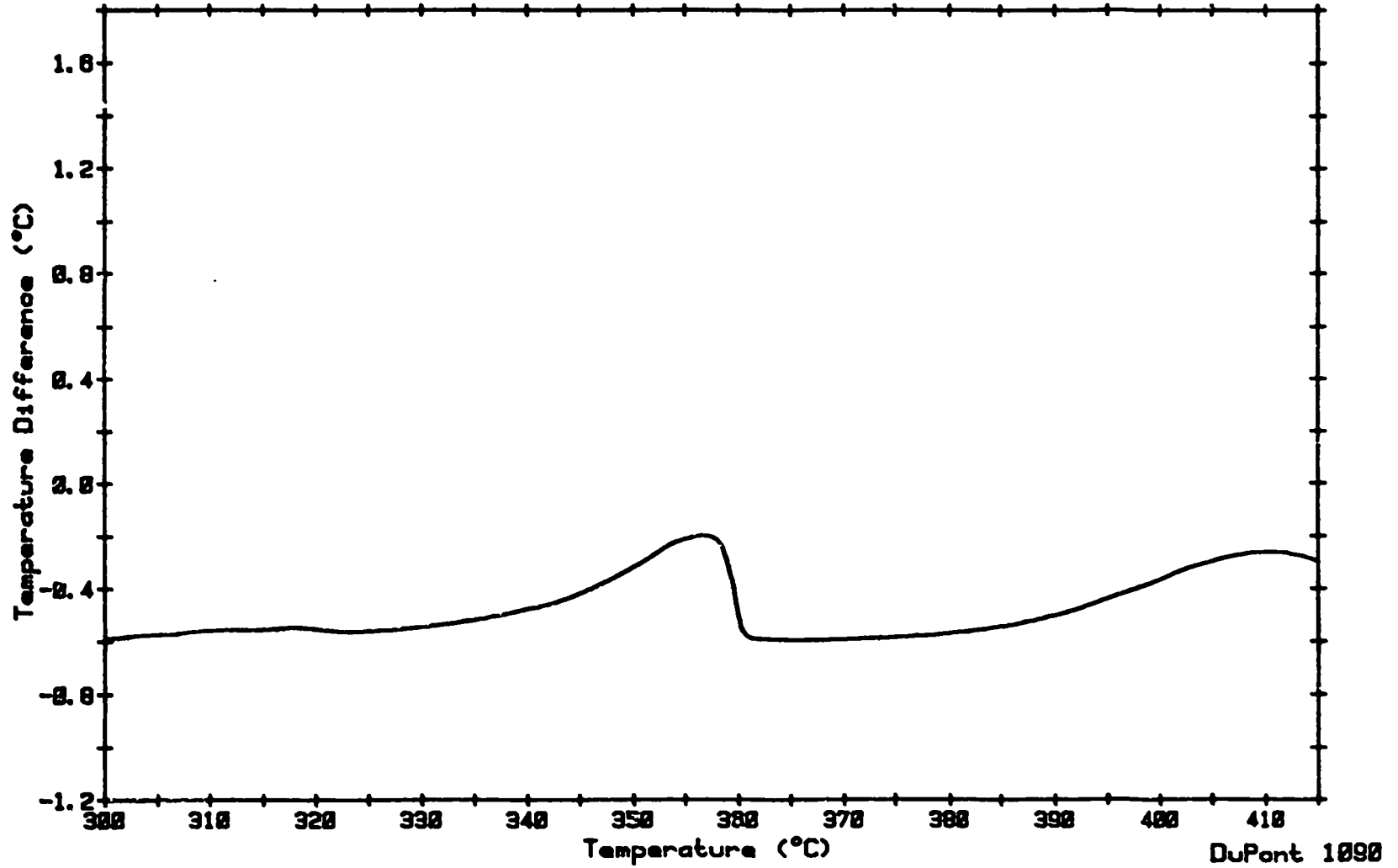

Figure A-28. UPLANT2-10, dry, micro, 5°C/min.

Sample: VENDOR MIX #1 AS RECEIV
Size: MICRO 0.0058 G
Rate: 10 DEG C/MIN
Program: Extended Playback V2.0

DTA

Date: 12-Jun-92 Time: 15:19:30
File: DTA.04 DTA24
Operator: H. H. CADY
Plotted: 24-Jun-92 11:44:48

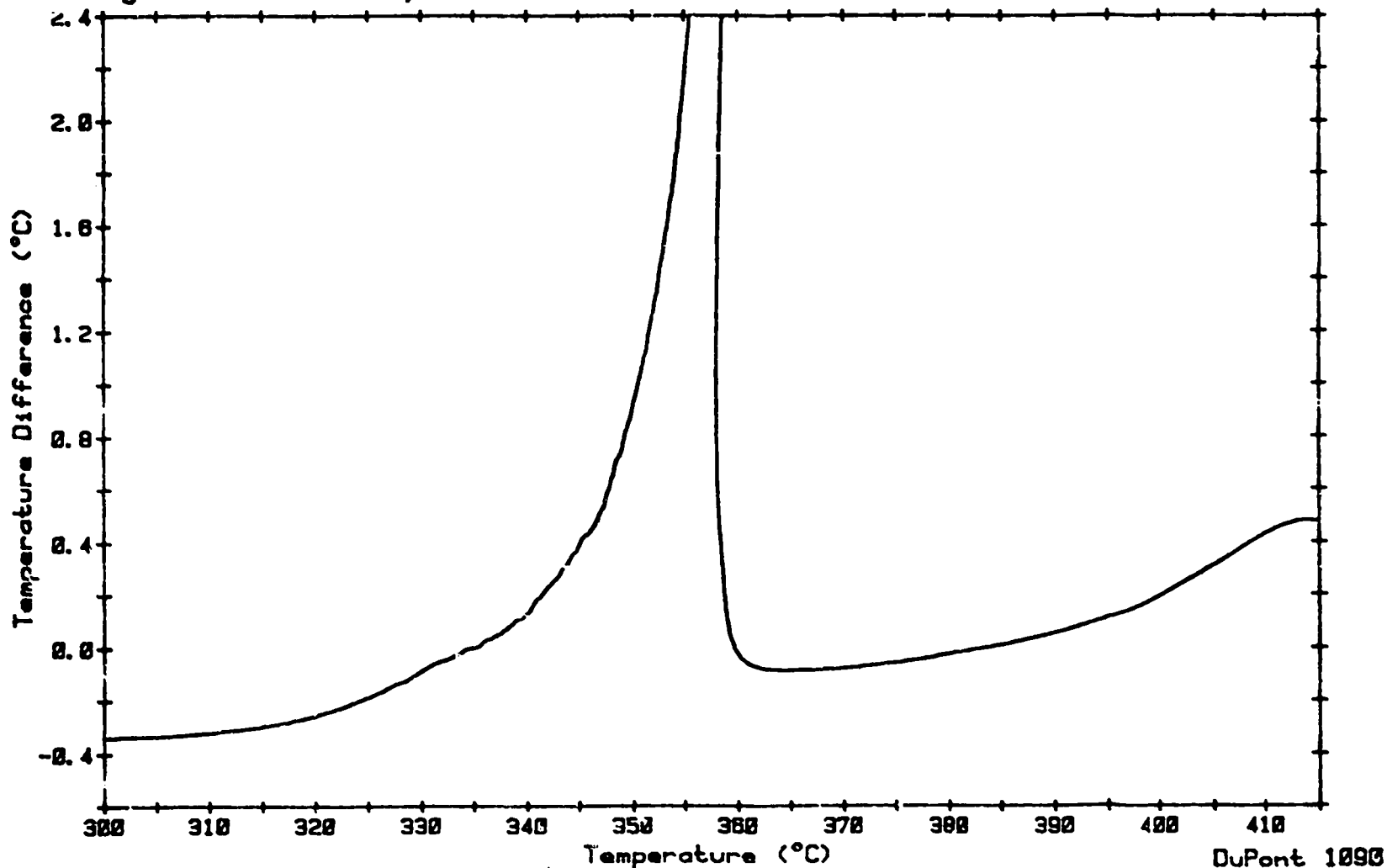

Figure A-29. VENDOR MIX#1, as received, micro, 10°C/min.

Sample: VENDOR MIX #1
Size: MICRO 0.0049 G
Rate: 5 DEG C/MIN
Program: Extended Playback V2.0

DTA

Date: 10-Jun-92 Time: 9:14:23
File: DTA.40 DTA23
Operator: H. H. CADY
Plotted: 24-Jun-92 17:37:32

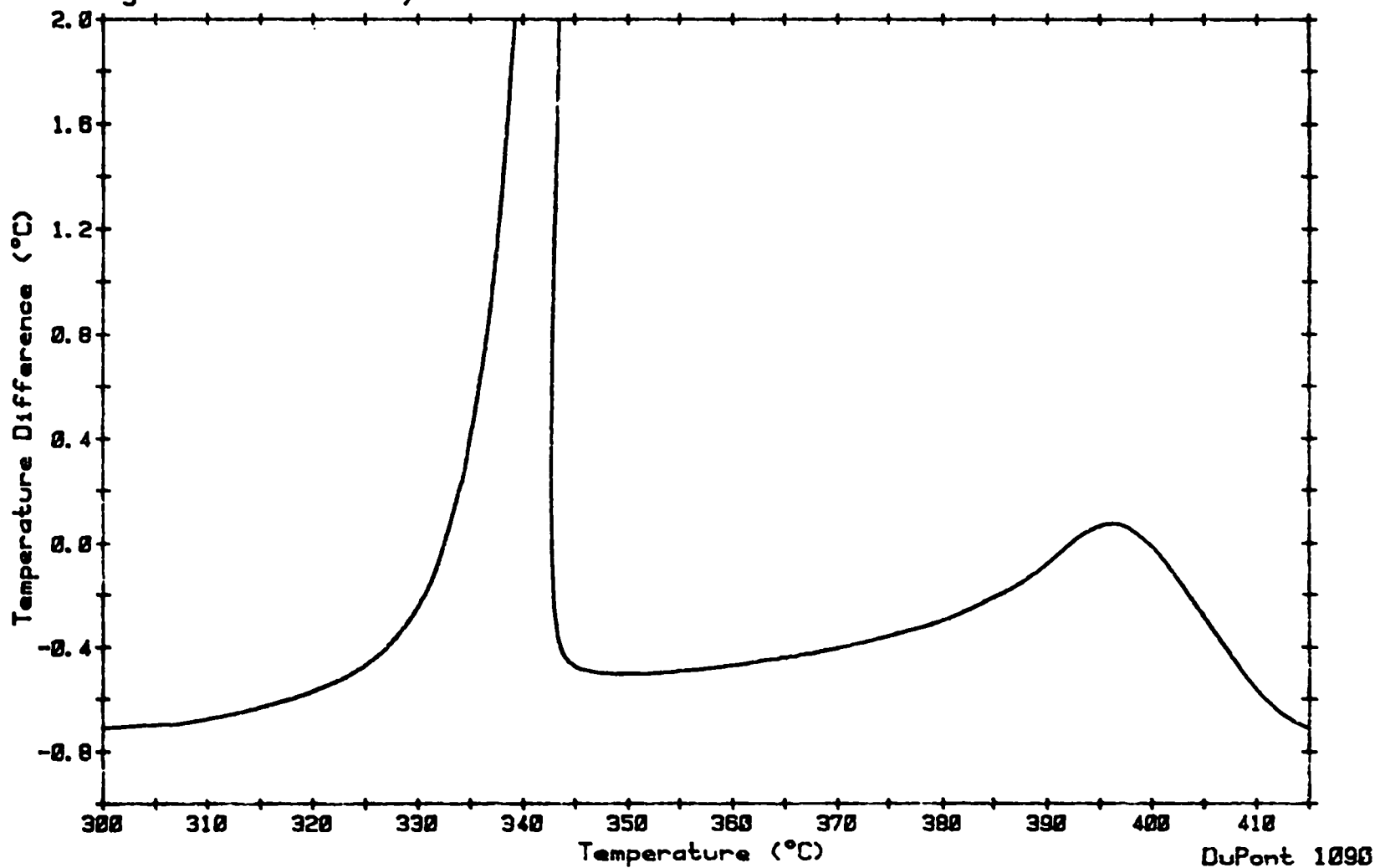

Figure A-30. VENDOR MIX#1, as received, micro, 5°C/min.