

# LEGIBILITY NOTICE

A major purpose of the Technical Information Center is to provide the broadest dissemination possible of information contained in DOE's Research and Development Reports to business, industry, the academic community, and federal, state and local governments.

Although a small portion of this report is not reproducible, it is being made available to expedite the availability of information on the research discussed herein.

CONF-811254-12

LA-UR 88-154

Los Alamos National Laboratory is operated by the University of California for the United States Department of Energy under contract W-7405-ENG-36

LA-UR--88-154

DE88 005387

TITLE: RECENT PROGRESS ON THE LOS ALAMOS AURORA  
ICF LASER SYSTEM

AUTHOR(S): L. A. Rosocha and L. S. Blair

SUBMITTED TO: Proceedings of Society for Optical and  
Quantum Electronics  
Lasers '87 Conference  
Lake Tahoe, Nevada  
December 7-11, 1987

By acceptance of this article, the publisher recognizes that the U S Government retains a nonexclusive, royalty-free license to publish or reproduce the published form of this contribution, or to allow others to do so, for U S Government purposes

The Los Alamos National Laboratory requests that the publisher identify this article as work performed under the auspices of the U S Department of Energy

MASTER

 Los Alamos National Laboratory  
Los Alamos, New Mexico 87545

DISTRIBUTION STATEMENT

## RECENT PROGRESS ON THE LOS ALAMOS AURORA ICF LASER SYSTEM

by

L.A. Rosocha and L.S. Blair

Los Alamos National Laboratory of the University of California  
P.O. Box 1663, MS-E548, Los Alamos, NM 87545

### Abstract

Aurora is the Los Alamos short-pulse, high-power, krypton-fluoride laser system. It serves as an end-to-end technology demonstration prototype for large-scale ultraviolet laser systems for short wavelength inertial confinement fusion (ICF) investigations. The system is designed to employ optical angular multiplexing and serial amplification by electron-beam-driven KrF laser amplifiers to deliver stacked, 248-nm, 5-ns duration multi-kilojoule laser pulses to ICF-relevant targets. This paper presents a summary of the Aurora system and a discussion of the progress achieved in the construction and integration of the laser system. We concentrate on the main features of the following major system components: front-end lasers, amplifier train, multiplexer, optical relay train, demultiplexer, and the associated optical alignment system. During the past year, two major construction and integration tasks have been accomplished. The first task is the demonstration of 96-beam multiplexing and amplified energy extraction, as evidenced by the integrated operation of the front end, the multiplexer (12-fold and 8-fold encoders), the optical relay train, and three electron-beam-driven amplifiers. The second task is the assembly and installation of the demultiplexer optical hardware, which consists of over 300 optical components ranging in size from several centimeters square to over a meter square.

### 1. Introduction

KrF lasers are promising candidates for inertial confinement fusion drivers (ICF) because they have the following specific advantages:

- Short wavelength (which couples more efficiently to fusion targets than either infrared or visible lasers);
- Decreased superthermal electron production;
- Increased plasma penetration, which leads to high ablation pressures;
- Broad bandwidth (which tends to decrease deleterious nonlinear plasma processes);
- High intrinsic laser efficiency;
- Economical construction cost;
- High energy scalability;
- Potential for repetitive operation.

However, because of a relatively low saturation flux, large nonsaturable absorption losses, and the non-storage nature (short excited state lifetime) of the laser medium, the KrF laser must be scaled to large aperture sizes and operated in a long pulse ( $>100$  ns) mode to produce efficient high energy (kJ- and MJ-class) outputs. Because efficient coupling of the laser energy to a fusion target requires a laser pulse duration with an energetic component of  $\sim 5$  to 10 ns, a means of matching the target pulse duration requirement to the laser amplifier pulse duration must be provided.

At Los Alamos, we have employed the technique of optical multiplexing to accomplish this match because it utilizes existing designs and conventional optical methods. Figure 1 shows the concept. The application of multiplexing to a kilojoule-class KrF/ICF laser driver will be investigated at LANL with the Aurora system.

The Aurora KrF/ICF technology demonstration prototype system employs optical angular multiplexing and serial amplification by electron beam-pumped KrF laser amplifiers to deliver 5- to 8-kJ, 248-nm laser pulses of 5-ns duration to ICF targets. Aurora is being built in two

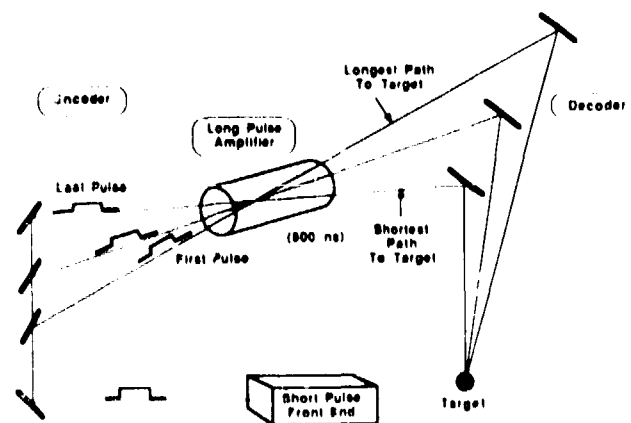

Fig. 1: A schematic diagram that illustrates the concept of optical angular multiplexing. From the front end pulse, an encoder produces a head-to-tail train of pulses that are slightly separated in path angle. This pulse train is then amplified and the individual pulses are sent along appropriate flight paths such that all the pulses arrive at the target simultaneously.

phases: the first phase (which has been essentially completed) includes the multiplexing and serial amplification features, while the second phase includes the additional end-to-end demonstrations of demultiplexing and delivery of laser pulses to fusion targets. The system has been described in great detail in several earlier publications.<sup>1-3</sup> The main power amplifier in the system, the Large Aperture Module (LAM) has a laser aperture of 1 m x 1 m and is the largest and most energetic existing ultraviolet laser of its type so far reported, having produced in excess of 10 kJ of 248-nm laser light when operated as a nonoptimized unstable resonator.<sup>4,5</sup>

The Aurora prototype will demonstrate critical technologies involved in developing KrF drivers for fusion and will serve as a test-bed for some particular technological aspects of larger laser fusion systems. In particular, Aurora will examine:

- uniform electron beam pumping of large laser volumes;
- optical angular multiplexing and demultiplexing systems that are scalable to large system designs;
- staging of large KrF amplifiers;
- uv pulse propagation over long paths;
- alignment of multibeam systems;
- novel approaches to optical hardware that can lead to cost reductions for even larger systems.

Figure 2 shows a conceptual layout of the Aurora system as it is presently configured. This figure illustrates all of the main optical and laser elements from the front end through the final power amplifier output, and on to the target system. The first phase part of the system employs the components from the front end to the LAM

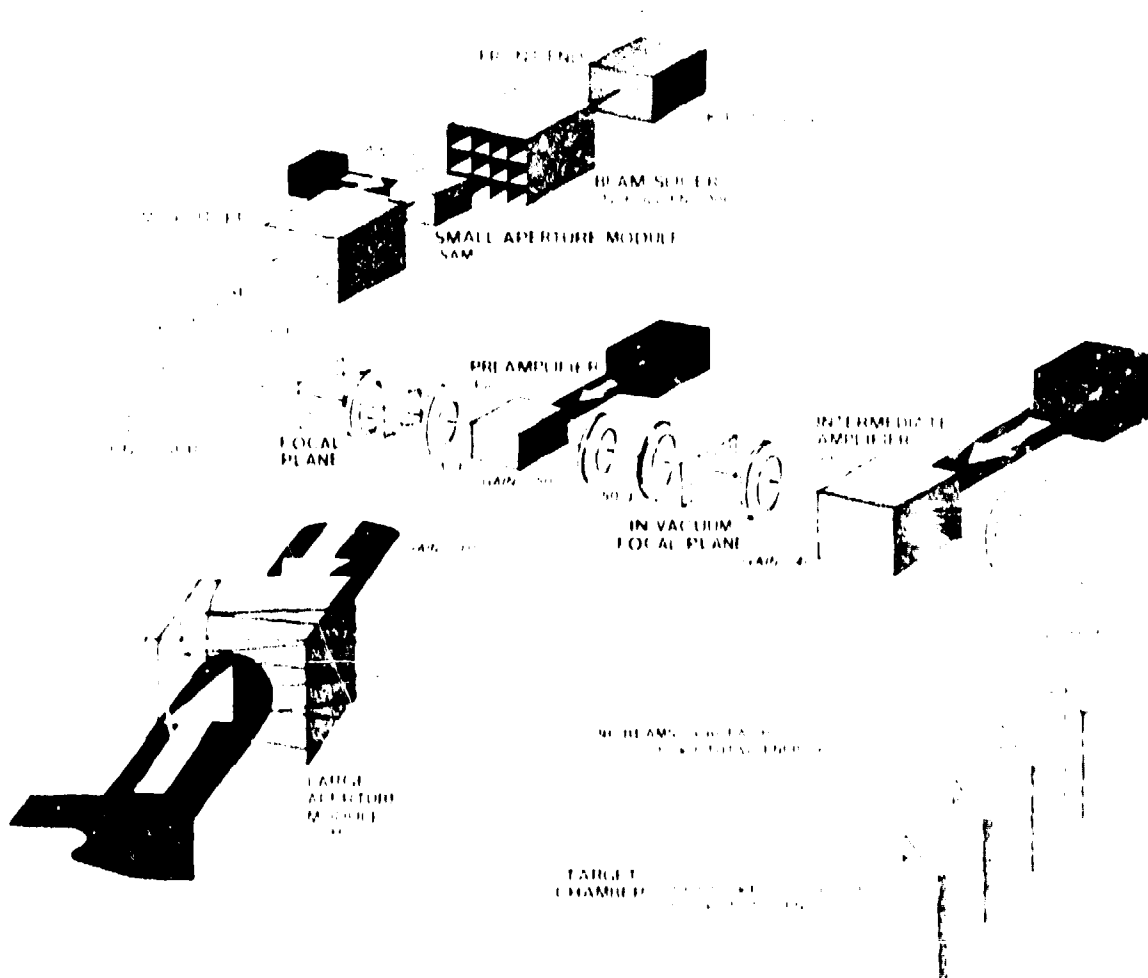

Fig. 2: A conceptual layout of the Aurora laser system. All of the main optical and laser elements from the front end, through the final amplifier output and on to the target are shown. Stage gains, number of beams, and beam energy are indicated at various points along the beam path. Typical delivered energy at the target is expected to be ~ 5 kJ in 48 beams.

output. In this phase, the basic approach is to replicate the front end output using aperture slicers, beamsplitters, and mirrors to produce a 480-ns long pulse train consisting of 96 beams each of 5-ns duration. These encoded (multiplexed) pulses, which are spatially separated, are then individually adjusted at the entrance pupil of an optical relay system. The beam train is then relayed through two single-pass laser amplifiers (the Preamplifier and Intermediate Amplifier), a double-pass laser amplifier (the Large Aperture Module), and delivered to the optical multiplexer (decoder). Beam train alignment to the multiplexer is accomplished with two automated alignment systems. One system points each of the 96 beams through the Preamplifier entrance pupil and the second keeps the Large Aperture Module primary mirror aligned in real time. In principal, a final optimized design output of 15 to 20 kJ can be expected from the LAM.

To deliver short-pulse KrF laser energy to fusion targets, the system will require decoder (demultiplexer) optics to compress the multiplexed beam train and a target facility to house and perform diagnostics on fusion targets. The second phase of Aurora will be concerned with an end-to-end demonstration of multiplexing, amplification, demultiplexing, and delivery of energy to target. Due to fiscal and programmatic constraints, only 48 beams from the set of 96 multiplexed and amplified beams will be demultiplexed and sent to target in the next one to two

years. Figure 3 shows an artist's conception of the second-phase Aurora system as it will appear with a 48-beam demultiplexer and target building in place. As configured, this system is designed to stack 48 of the 96 beams into a single multi-kilojoule 5-ns pulse at the fusion target.

In this paper, we will present brief surveys of the front end, the amplifiers, the multiplexer and relay optics, the alignment system, and the demultiplexer optics. The target irradiation apparatus, which is adequately treated elsewhere,<sup>6</sup> will not be described here, other than to say that considerable progress has been made in the installation of the target chamber and associated apparatus. Progress achieved in the construction, testing, and integration of the laser system over the past year will also be discussed.

## 2. Front-End System

The front-end system provides the initial pulse that is replicated and then amplified for delivery to the target. The Aurora front-end system is progressing in stages that correspond to the two phases of the project. An interim front end now provides 5-ns pulses adequate for startup and initial integration of the amplifier chain. A front end to be installed later (but developed during the past year) will provide high-contrast ratio, pulse shaping, and bandwidth flexibility.

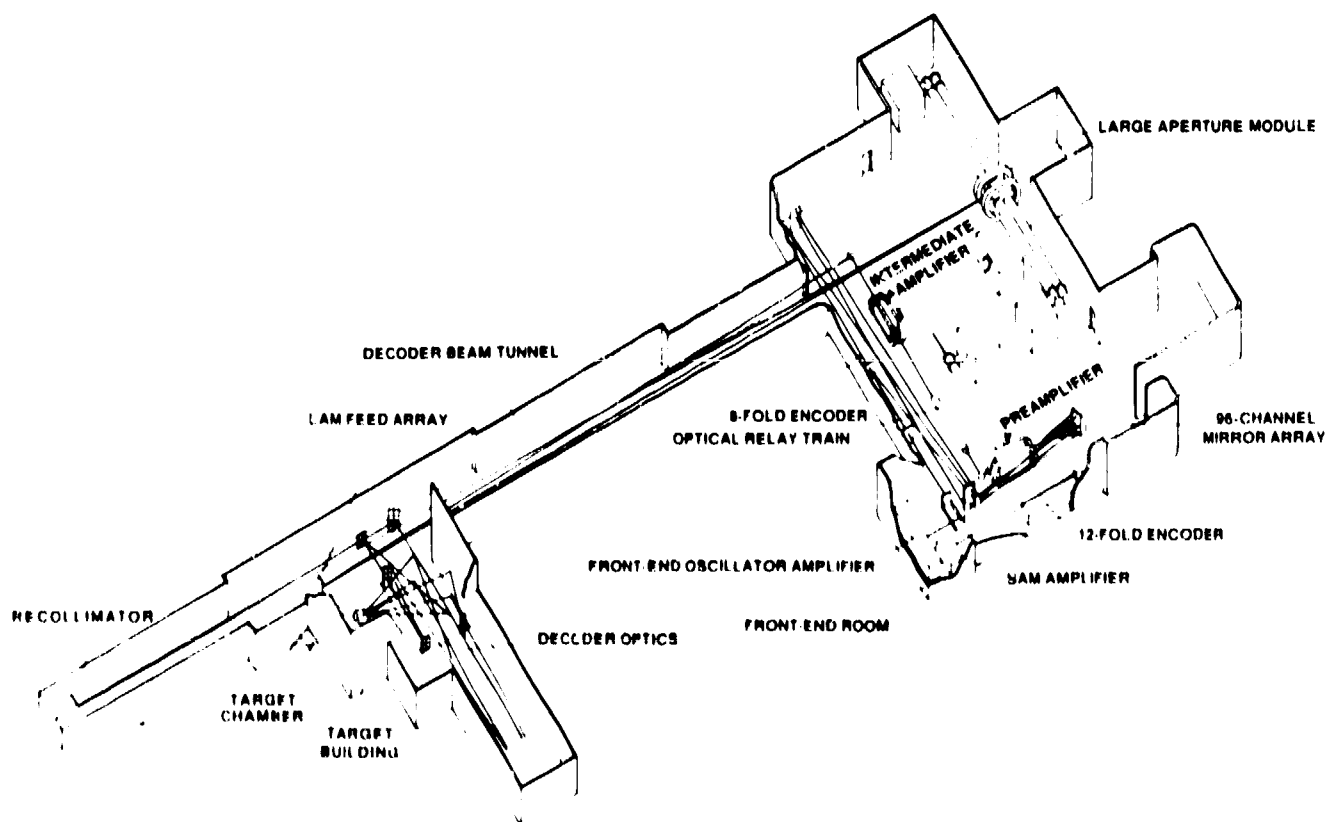

Fig. 3: An artist's conception of the Aurora system with the 48-beam decoder and target building in place. Most of the system is now built and is in the process of system integration.

## 2a. Baseline Front End for Multiplexing Demonstrations

The first-phase front-end system uses Pockels cells to switch out a 5-ns pulse from a longer 25-ns pulse produced by a commercial electric discharge-pumped, injection-locked KrF oscillator-amplifier system. The 5-ns pulse is then split into two identical 5-ns pulses that are then amplified by a commercial TEA KrF postamplifier and sent to the 12-fold encoder (multiplexer). The combined energy of the two pulses is approximately 250 mJ. The performance of the system (total energy, contrast ratio, and beam divergence) is determined by the characteristics of the Pockels cell, the oscillator-amplifier, and the post amplifier.

After emerging from the second switch and polarizer set, the single 5-ns pulse is split into two identical pulses by the beamsplitter and then passed through two parallel electric discharge post amplifiers. Upon emerging from the post amplifiers, the two 5-ns pulses typically contain a total energy of approximately 350 mJ; this is more than sufficient energy for the multiplexing demonstration. The shape of the 5-ns pulses emerging from the post amplifiers is determined by the effective excited state lifetime of the KrF gain medium (which is due to a short spontaneous lifetime of about 6 ns and the effect of collisional quenching). The KrF gain medium is in fact an energy storage medium with an effective lifetime of 2 - 2.5 ns, which results in an amplified pulse with a strong spike on the leading edge.

## 2b. Advanced Front End for Target Shooting

The above front-end configuration meets the requirements for the proof-of-principle demonstration of the technique of angular multiplexing, but will not be adequate for the delivery of energy to fusion targets since the contrast ratio is only of order 100:1. To provide a high quality target-shooter front end, Stimulated Brillouin Scattering (SBS) phase-conjugate mirrors have been used to improve the baseline front end lasers.

The modified front end<sup>7</sup> (which contains many components common to the baseline front end) is shown in Figure 4. It takes advantage of commercially available units, which are then appropriately modified. A Lambda Physik Model EMG-130 KrF laser (which contains two discharge heads that are used as an oscillator-amplifier arrangement) comprise the main components of the new front end. The oscillator cavity, which consists of a 10-m concave high-reflectivity mirror and a 60% reflectance flat output coupler separated by 1.25 m with a 1-mm intracavity aperture, was operated with a moderate amount of dispersion provided by a single prism. This resulted in a bandwidth of  $\sim 10 \text{ cm}^{-1}$ . The 10-mJ, 20-ns pulse from the oscillator is optically delayed by 20 ns to compensate for the built-in delay between the two discharge laser heads. A polarizer placed in the output beam provides linear polarization. A beam-expanding telescope then expands the beam to overfill the 1.5-cm x 3.0-cm cross section of the preamplifier. An aperture at

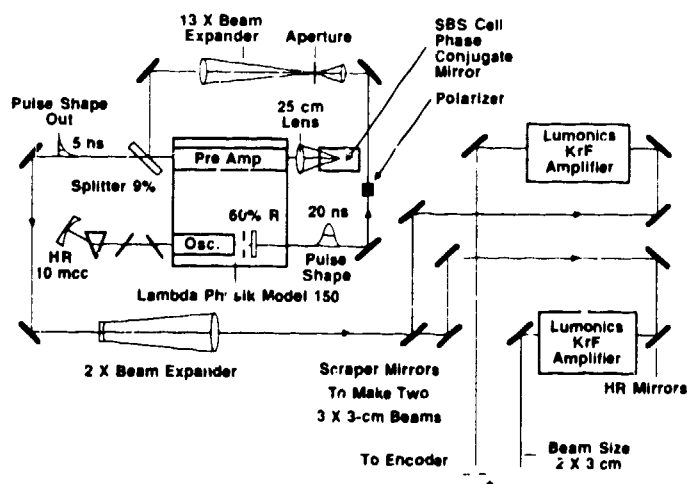

Fig. 4: Schematic diagram of the Aurora front end using phase conjugation by Stimulated Brillouin Scattering (SBS).

the focus of this telescope stops the backward amplified spontaneous emission (ASE) from damaging the telescope input lens if the oscillator fails to operate. The beam is injected into the preamplifier by a 9% S-plane reflection from an uncoated wedged beamsplitter.

After one pass of amplification, the beam is focused by a 25-cm focal length lens into the SBS cell containing 20 atm of  $\text{SF}_6$ . The phase-conjugate reflection produced when the medium reaches threshold is returned through the preamplifier, amplified a second time, and taken through the beamsplitter. The SBS pulse width can be varied by attenuating the oscillator beam. This controls the amount of time required to reach threshold in the SRS medium. The oscillator attenuation has been adjusted to provide the required pulse width of 5 ns. This pulsewidth is very reproducible ( $<0.2 \text{ ns}$  pulse-to-pulse variation).

The 1.5-cm x 3.0-cm output beam from the preamplifier is expanded with a 2x telescope to form a 3-cm x 6-cm beam. This beam is split with a scraper mirror into two identical square beams of size 3 cm x 3 cm. Each of these beams is single-pass amplified through a separate Lumonics amplifier and delivered to the encoder.

The performance of the advanced front end shows improvement in several areas when compared with the baseline front end that used Pockels cells and polarizers to create the 5-ns pulse. The prepulse has been reduced as evidenced by an instrumentation-limited measurement, which showed a prepulse energy of  $<10^{-4}$  of that in the main pulse. Final beam quality from the amplifier is now 1.5 times diffraction limited (1.5 x DL) as compared to 5.0 x DL previously. The output energy has been doubled and the maximum pulse repetition rate has been increased from one pulse per minute to 0.5 Hz.

### 3. Amplifiers

The Kr/Ar/F<sub>2</sub> gain medium in the Aurora amplifiers is pumped by cold cathode electron guns, the details of which have been described elsewhere.<sup>1,8</sup> In summary, the electron guns make use of planar cold cathode diodes with graphite felt emitters ranging in emission area from 1,200 cm<sup>2</sup> to 20,000 cm<sup>2</sup>. The diodes are typically driven by Marx generator-charged pulse forming lines (PFLs) of low impedance (~2.7Ω for most amplifiers). The typical electrical pulse length is 650 ns, the diode voltage 500-650 kV, and the current density 25 A/cm<sup>2</sup> at the cathode. Electron current is transported into the laser gas with ~50% efficiency through Ti foils and a hibachi support structure. Externally applied magnetic guide fields of 1.5 to 3 kGauss are used to provide uniform current delivery.

The main amplification chain for Aurora consists of four electron beam-driven KrF laser amplifiers ranging in aperture size from 10 cm x 12 cm to 100 cm x 100 cm. These devices are specified the Small Aperture Module (SAM), the Preamplifier (PA), the Intermediate Amplifier (IA), and the Large Aperture Module (LAM). The characteristics of these four amplifiers are summarized in Table I.

Table I  
Summary of Amplifier Specifications

Device	SAM	PA	IA	LAM
Pump pulse length (ns)	100	650	650	650
E-Gun voltage (kV)	300	675	675	675
E-Gun current in gas (A/cm <sup>2</sup> )	12	10	10	12
E-Gun area (m <sup>2</sup> )	0.12	1.20	1.20	2.00
Input / output light energy (J)	0.25/5	1/50	50/2k	2k/20k
Stage gain	20	50	40	10
Laser aperture (cm x cm)	10x12	20x20	40x40	100x100

Figures 5-7 show some of the amplifier hardware. At present all amplifiers have been operated successfully as lasers, although the pumping of the IA needs improvement in magnitude and uniformity. The LAM is representative of all of the amplifiers in the Aurora chain, except that the PA and IA use single-sided electron beam pumping and the SAM does not use a PFL. The theoretical performance of these amplifiers has been discussed in detail elsewhere.<sup>1,9</sup>

The actual performance of these laser devices has been determined by experiments conducted to measure the gain and by integrated 96-beam energy extraction measurements. Figures 8a and 8b display the measured values of small-signal gain<sup>10</sup> for the PA and IA, while Table II gives the measured amplifier performance. The

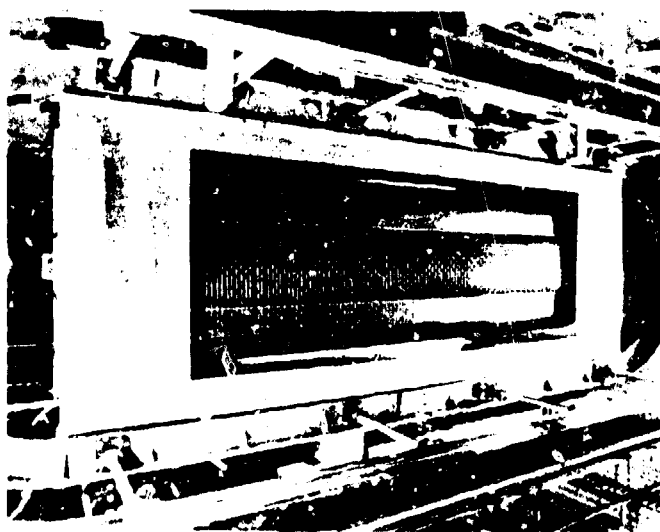

Fig. 5: Photograph showing the interior of the Preamplifier (PA) cold cathode diode.

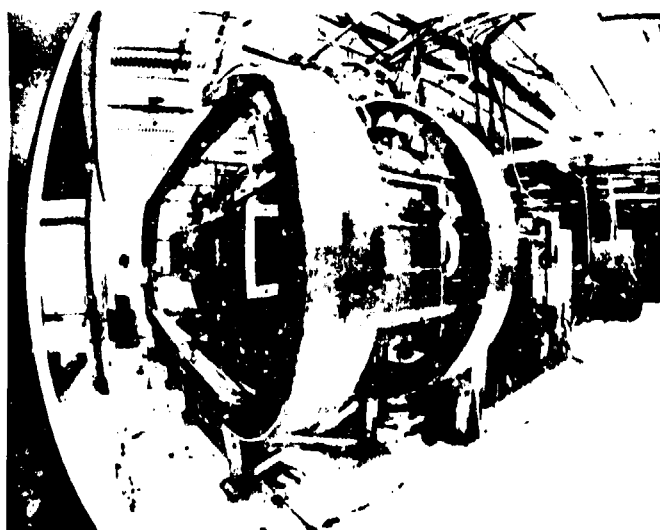

Fig. 6: A photograph showing the assembled Intermediate Amplifier (IA). The laser chamber, diode vacuum box, and the guide magnets are visible in the foreground; the Marx generator and water PFLs are slightly visible in the background.

12-element beam train shown in Figure 9a is incident at the SAM, amplified, and replicated into a 96-element beam train<sup>11</sup> shown in Figure 9b. Amplification of this 96-element train is discussed in Section 5 of this paper.

## 4. Optical System

### 4a. Multiplexer and Alignment Systems

The Aurora optical system is representative of typical angularly multiplexed systems. It is designed to match the long amplifier electrical excitation pulse time, which is determined by electrical and laser kinetics considerations, to the much shorter pulse times required for efficient

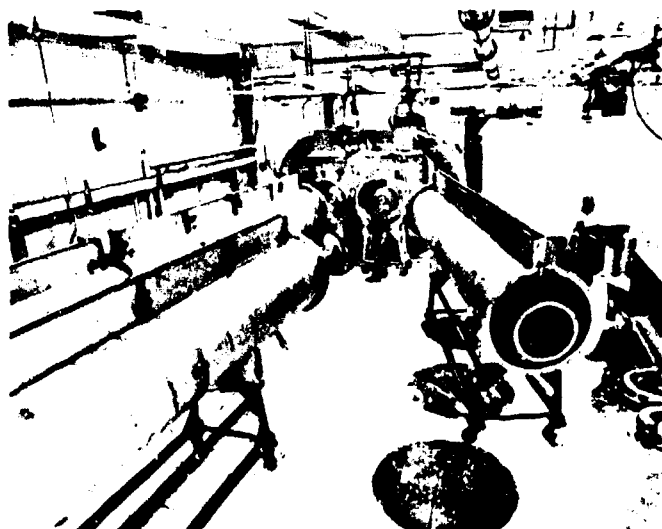

(a)

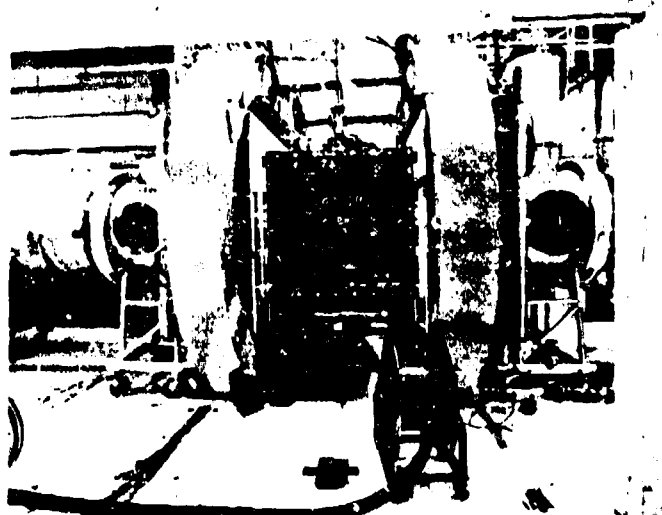

(b)

Fig. 7: Photographs showing (a) the assembly of a set of improved LANL-designed PFLs for the Large Aperture Molecule (LAM) and (b) the diode box, laser chamber, and guide magnets.

coupling of the laser pulse energy to inertial fusion targets. This system uses angle and time multiplexing to perform this match. Distance is used to provide the necessary time delays needed to time-encode and decode a 96-beam pulse train of 5-ns pulses. The major parts of the system are: (1) an optical encoder that replicates the 5-ns front-end output pulse to produce a 480-ns long pulse train consisting of 96 separate beams placed head-to-tail in time; (2) an angle encoder that spatially separates the beams so that they can be decoded at some later time and also helps to direct the beams through the amplifiers; and (3) a centered optical system that relays the beams through the amplifiers so that the beams expand and fill the active gain volumes; (4) an optical decoder to appropriately delay the earlier pulses in the pulse train

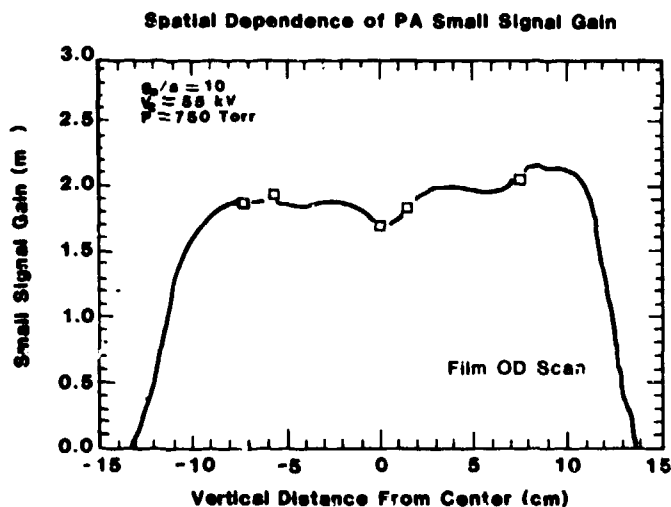

(a)

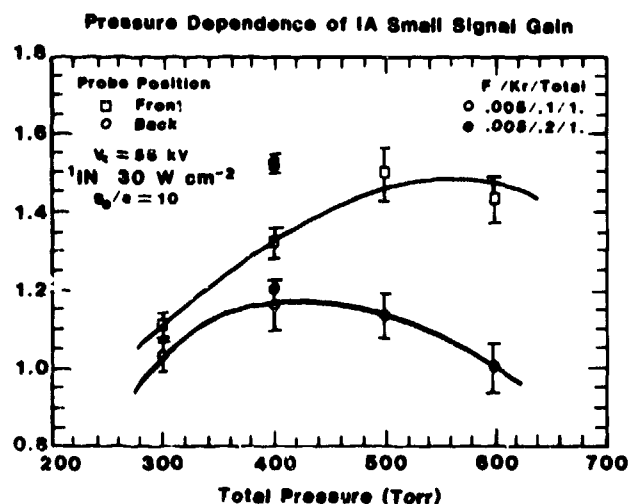

(b)

Fig. 8: Results of measurements of Aurora mid-chain amplifier gain at low pump rate. (a) Spatial dependence of PA small-signal gain at 80 kW/cm<sup>3</sup>. (b) Pressure dependence of IA small-signal gain at 40 kW/cm<sup>3</sup>.

relative to the later pulses so that they all arrive at the target at the same time; (5) a set of final aiming mirrors and focusing lenses that direct the beams onto the target; and (6) three optical alignment systems that control the alignment of the encoder, the final amplifier feed mirror array, and the final aiming mirrors. Figure 2 has shown a conceptual layout of the optics in Aurora. Figure 10 shows the key parts of the assembled multiplexer hardware. Figure 11 shows the automated multiplexing alignment system that can simultaneously align all 96 beams to an accuracy of 3 to 5  $\mu$ rad in approximately 3 minutes; two other separate alignment systems will be required for the fully integrated Aurora system.



Table II  
Measured Performance of Electron-Beam-Pumped Amplifiers

Device	PA	IA	LAM	LAM
Marx charge (kV)	55	55	45	60
F <sub>2</sub> (torr)	3.75	2.00	3.00	3.00
Kr (torr)	75	40	60	60
Total gas pressure (torr)	750	400	600	600
Deposited energy (kJ)	10	18	123	173
Volume (liters)	176	597	2000	2000
Specific energy (J/l)	56	29	67	87
Pump rate (kW/cm <sup>3</sup> )	80	42	95	144
$g_0$ (m <sup>-1</sup> ), premix	2.06	1.33	2.05	Osc.
$g_0$ (m <sup>-1</sup> ), <i>in situ</i>	1.86	1.16	1.90	Osc.
Extracted energy (kJ)	SSG	SSG	SSG	10.7

Notes:

1. Osc.: oscillator experiments.
2. SSG: small-signal gain experiments.
3. premix: premixed laser gas.
4. *in situ*: laser gas mixed in chamber.

The optical system (multiplexer, demultiplexer, and associated alignment systems) have been described in detail in other publications.<sup>1-3,12</sup> In this paper, we will deal with recent progress achieved in the assembly of the demultiplexer.<sup>13</sup> Recently, several years of design, procurement and assembly have culminated in the accomplishment of a major Aurora milestone, namely the installation of all of the demultiplexer hardware, which consists of over 300 optical components ranging in size from several centimeters square to over a meter square. All optics are installed and all optical mount drive motors and motor controllers are installed and operational.

#### 4b. Optical Demultiplexer System

Because the ICF target requires a short pulse of ~5-ns duration, the 480-ns amplifier pulse must be compressed for second-phase Aurora. The synthetic long pulse which feeds the LAM consists of a train of 96 separate 5-ns pulses. The 96 pulses that have been encoded in the multiplexer are then decoded in the demultiplexer to compress the long pulse train into a single high-power pulse. This is accomplished by sending the beams along different flight paths to the target. Initially, for budgetary and programmatic reasons, only 48 of the 96 beams will be decoded and delivered to the target.

Figure 12 is a diagram that illustrates the demultiplexer (decoder) layout. All 96 beams leave the last lens of the relay train (centered optical system), which is near a pupil, at different angles separated by 1.8 mrad. They are directed toward the LAM feed array (Fig. 13a), which is the first position after the centered optical system where the beams can again be individually pointed. The beam

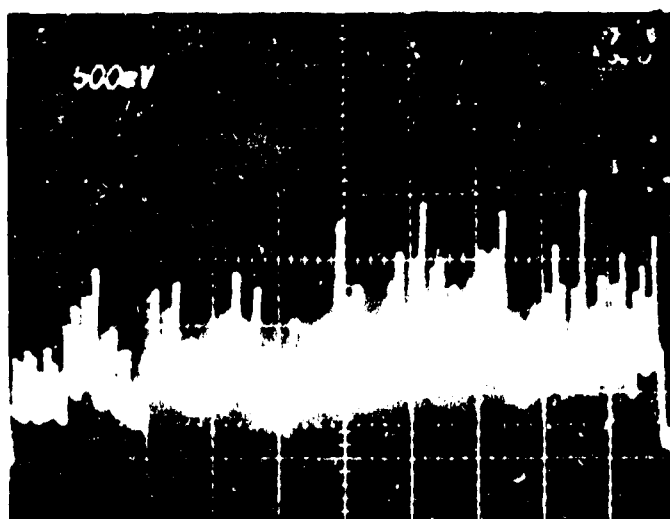
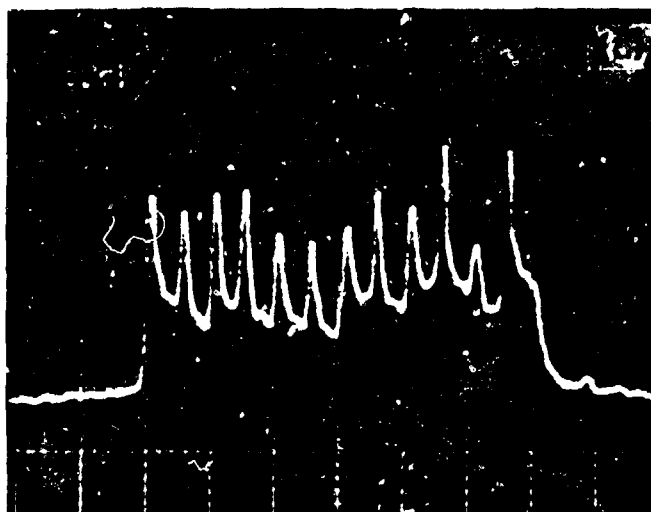
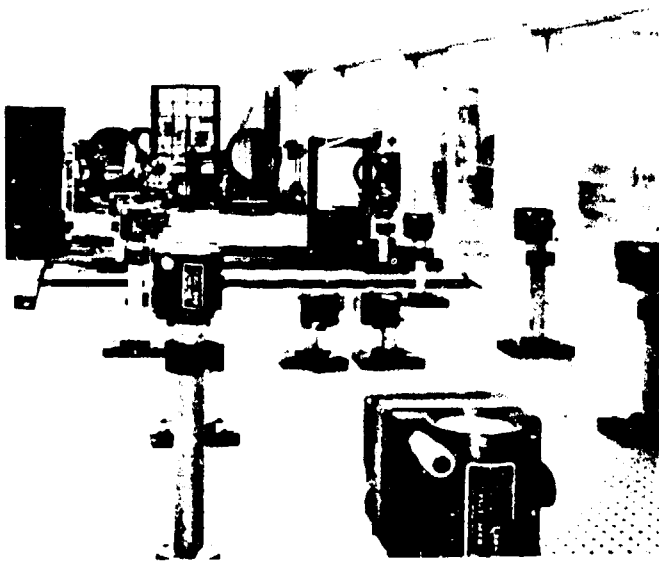
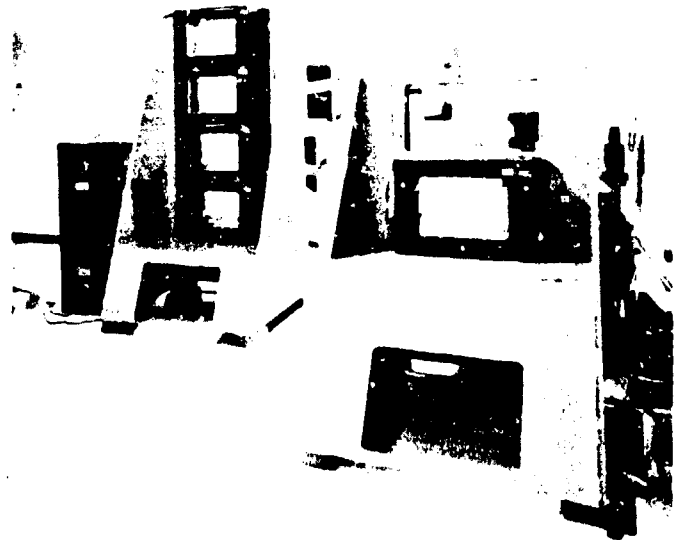

Fig. 9: (a) Twelve-element beam train incident at the SAM. (b) Ninety-six-element beam train incident at the PA.

position and spacing on the feed array are determined by the recollimator array spacing and position. Each convex mirror in the feed array is 10-cm square. However, the beams on the array are only 5-cm square. The radius of curvature of the convex mirrors is 5.99 m. Each feed array mirror points at the LAM and expands the 5-cm beam to 1 m to fill the amplifier with light. The concave 107-m radius of curvature LAM mirror causes the beams to converge along the path toward the recollimator array (Fig. 13b) where the beams are again separated. The recollimator mirror spacing is 18 cm center-to-center. At the recollimator array, the beams are 14-cm square. The 17-cm square convex recollimator mirrors have a 35.12-m radius of curvature. They recollimate the beams and direct them toward the 61-cm square fold mirrors shown in Figure 14. A view of the LAM feed array, recollimator array and fold mirrors is shown in Figure 15. The fold mirrors point the beams toward the line decoder, Figure 16, which takes out the beam-to-beam time delays and direct the beams to the final aiming array shown in



(a)



(b)

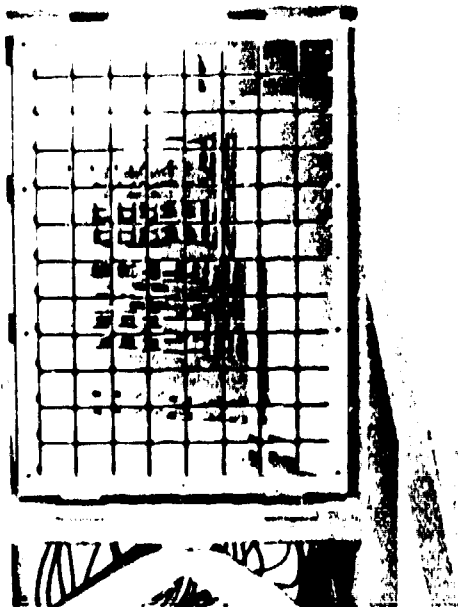

(c)

Fig. 10: Ninety-six-beam Aurora multiplexing is accomplished with three systems: (a) 12-fold encoder (aperture division), (b) 8-fold encoder (intensity division), (c) 96-element, computer-controlled angle-multiplexing mirror array.

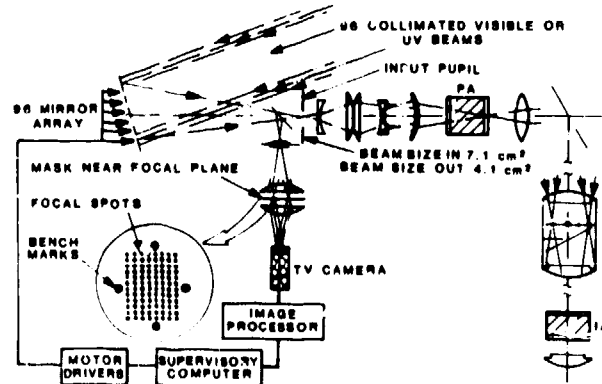

Fig. 11: The input pupil array alignment station feedback loop. A dichroic beamsplitter before the input pupil reflects collinear visible beams to a 96-spot focal plane on a mask with benchmarks. The spots are image-processed and positioned relative to the benchmarks by driving the input pupil array mirrors. From Reference 12.

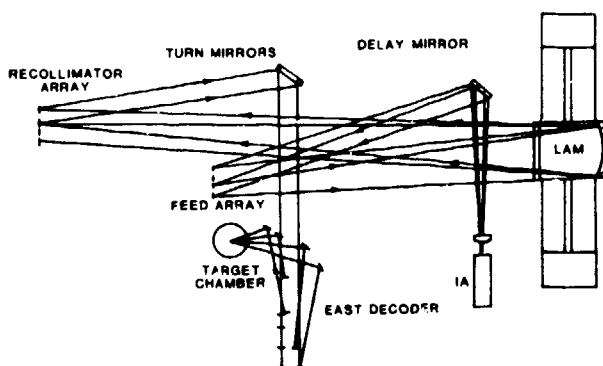

Fig. 12: Present 48-beam demultiplexer layout with one-sided target illumination (not to scale and only a few beams shown). A 240-ns delay is required; a 120-ns delay is hidden in turn and grade change from a separation tunnel in the fine decider wing.

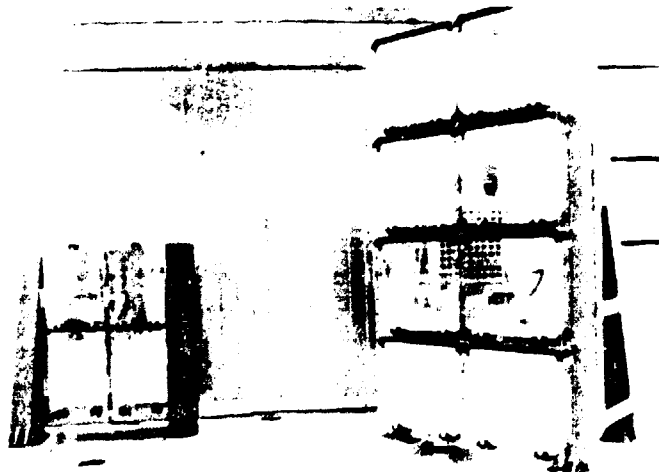
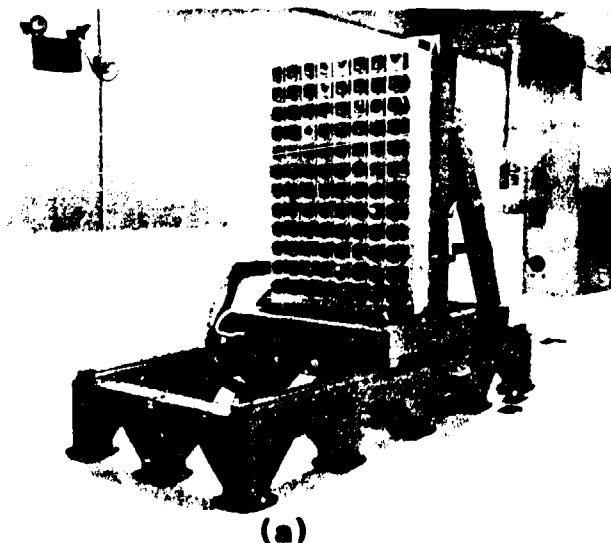
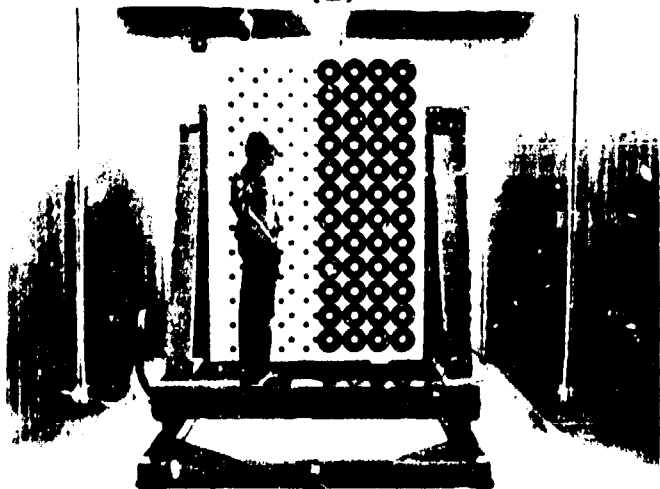

Fig. 14: Fold mirror arrays showing the stands and lightweight mirrors.



(a)



(b)

Fig. 13: (a) Ninety-six-element LAM feed array. (b) Forty-eight-element recollimator array. These arrays are assembled and integrated into the upstream optical system.

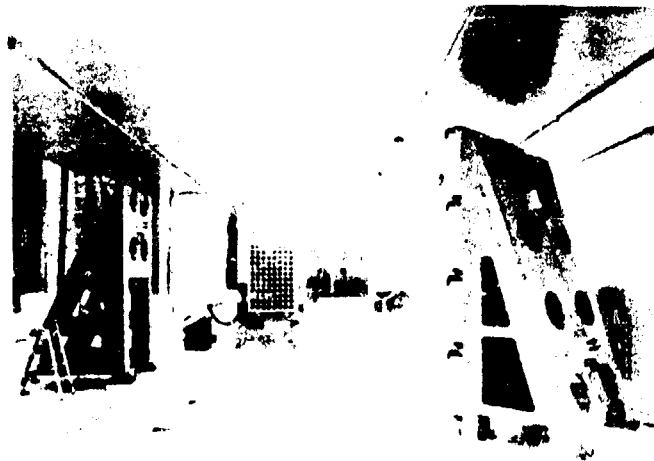

Fig. 15: A view down the beam tunnel showing the LAM feed array (left), fold mirrors (right), and recollimator array (far background).

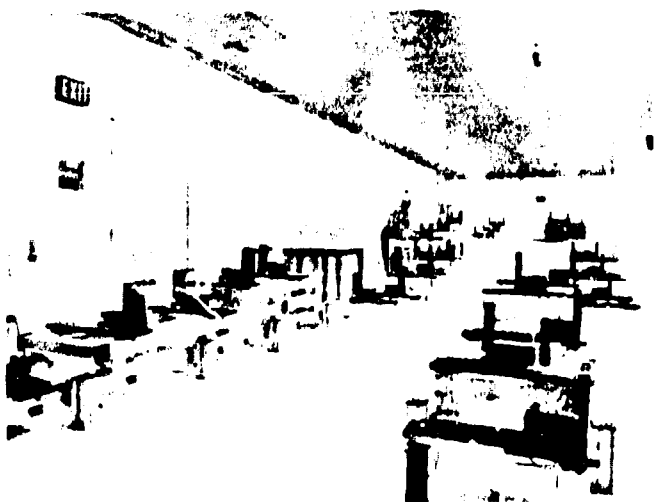

Fig. 16: The fine decoder stands and mirrors; these remove the 5-ns time delays between adjacent beams.

Figure 17. The aiming mirrors point the beams through the target lenses, shown in Figure 18, which focus all the beams onto the target plane (at a best-focus spot size of 200  $\mu\text{m}$ ).

The fabrication of these components has been progressing for the past few years. The Aurora hardware represents a reasonable assessment of the present off-the-shelf industry capability, quality, and cost for large KrF laser system optical components. Almost all parts were specified to have a surface figure of at least  $\lambda/10$  or better at 633 nm. This specification did not appear to drive the cost. For all but the largest parts, we were able to check the parts at LANL to ensure accuracy and quality.

The part-to-part tolerance for the convex LAM feed mirrors, convex recollimator array mirrors, and the target lenses were the most difficult to obtain and verify. The lightweight pyrex mirrors that are shown in Figure 14 proved to be the most cost-effective approach for the larger mirrors in the system. These mirrors now represent a proven technology that can be applied to future systems.

Ongoing work on the optical system is concentrating on the target alignment apparatus and the integration of the optical system to the amplifiers.

#### 5. Recent Progress in System Integration

The most significant system integration milestone achieved during the past year was the extraction of amplified 96-beam energy from the Intermediate Amplifier.

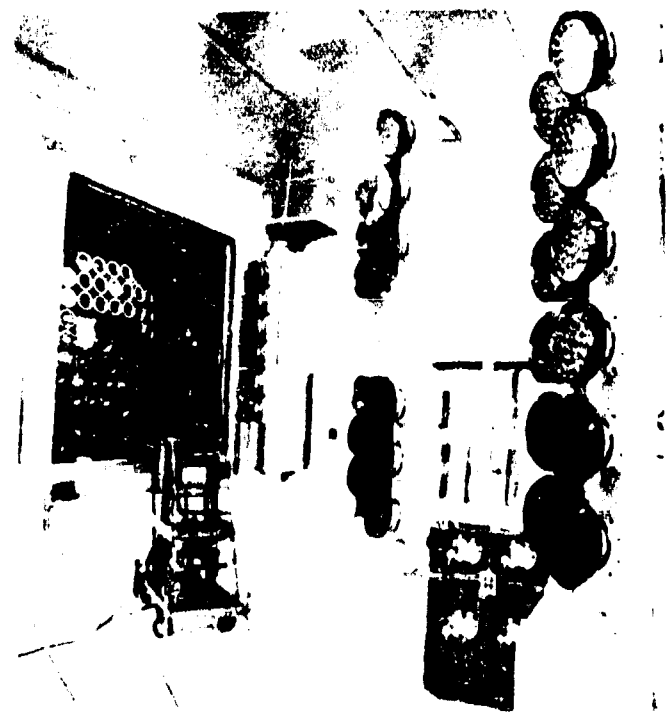

Fig. 17: The final aiming mirror stand and the 48 mirrors that point the beams at the target focusing lenses.

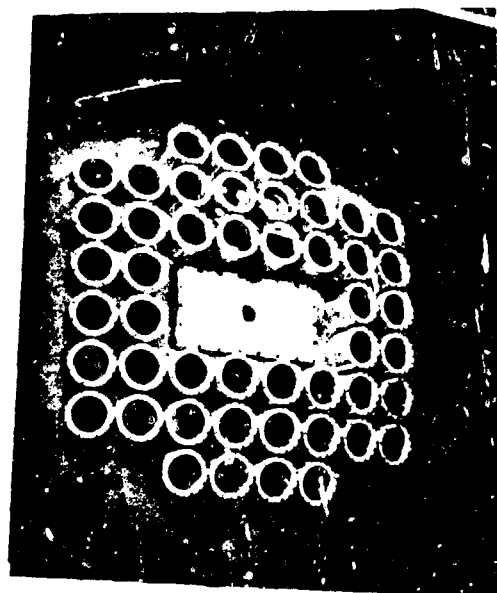

Fig. 18: A view of the lens plate and the 48 target focusing lenses.

For this demonstration, the front end, SAM amplifier, the 12-fold and 8-fold encoders, the Preamplifier, the optical relay train, and the Intermediate Amplifier, were operated as an integrated chain. The experimental setup is shown in Figure 19. A 96-element beam train containing 256 J was extracted from the IA output. Although this is not the design value of  $\sim 1$  kJ, it represents a significant step in the integration of the entire Aurora laser system.

At present, we have made some improvements in the SAM gain and are making some improvements in the PA and IA that should allow the extraction of near-design energy from the amplifier chain. We are now preparing another system integration experiment that will demonstrate the integration of virtually all of the Aurora system. In the upcoming experiment, the 96-element beam train from the IA will be delivered to the demultiplexer, where 48 beams will be decoded and delivered to the target plane. A modest amount of delivered energy ( $\sim 100$  J) is planned for this demonstration. After that achievement, the LAM will be added to the system.

#### 6. Remaining Issues

Aurora was built as an experiment to examine many of the technology issues related to high power KrF/ICF lasers. So far, we have demonstrated 96-beam multiplexing and energy extraction, amplifier staging, and precise optical alignment. Several other secondary issues are also in need of examination to optimize the performance of Aurora and to resolve potential problems. These are:

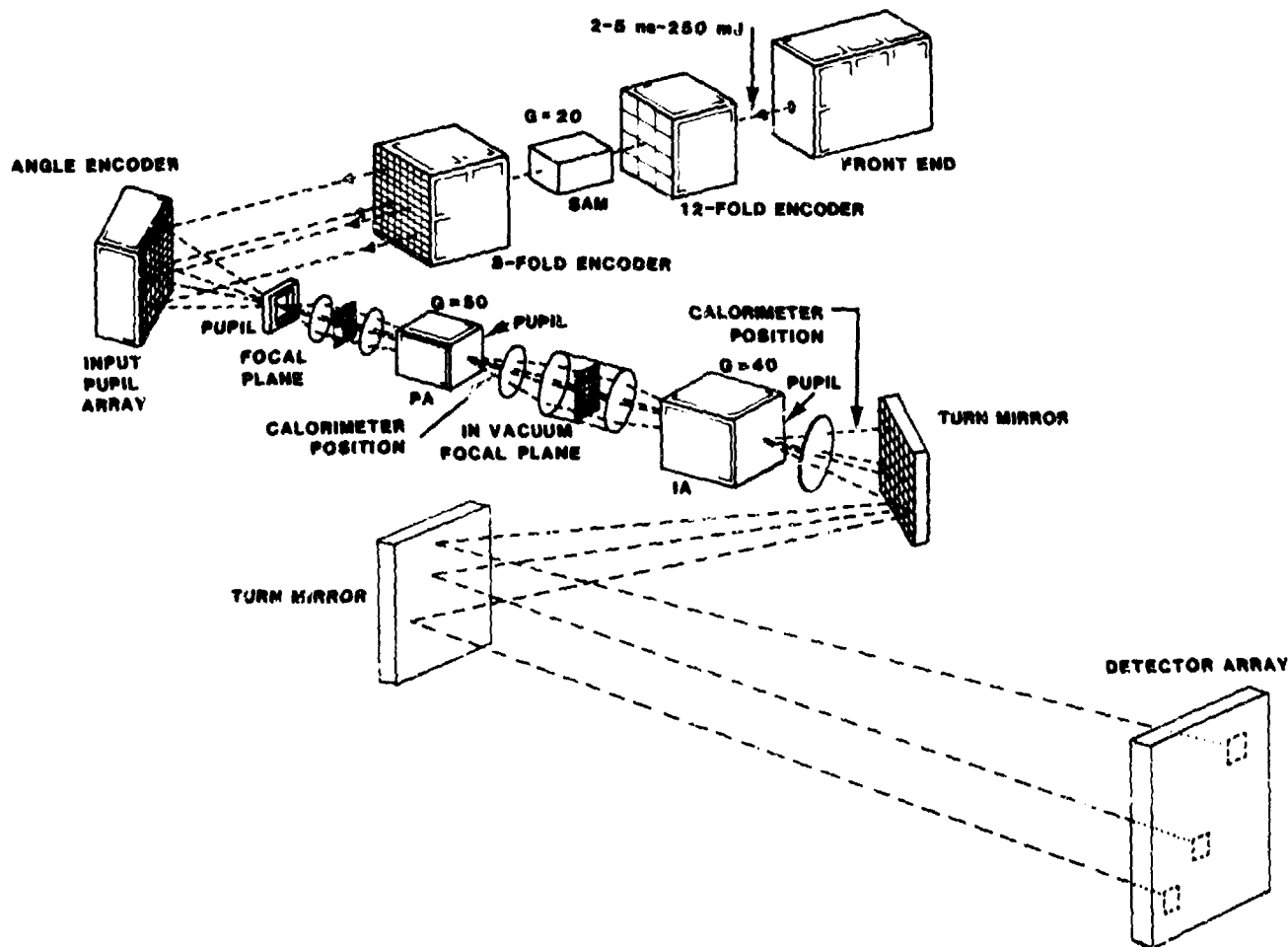

Fig. 19: Ninety-six-beam energy extraction experiments are proceeding through the Aurora amplifier chain. Amplifier chain performance to date: 256 J of 248-nm laser radiation has been extracted from the Intermediate Amplifier, driven by the front end, multiplexer, Small Aperture Module, and Pre-amplifier.

- Multiplexer/demultiplexer crosstalk and scattering from optical coatings that may contribute to crosstalk;
- Laser- and fluorine-induced damage to optical coatings;
- E-beam pumping uniformity limitations;
- Laser gas chemistry and contaminants;
- Long-path beam propagation;
- Pulse shaping.

These issues are now under examination and will continue to be studied during the next year.

#### Acknowledgments

The authors would like to express their appreciation to the entire Aurora project team for the many contributions toward progress reported in this paper. In particular, we thank Scott Thomas and Jack Hanlon for writing large parts of the front end and optics sections, respectively. We also thank Ruth Holt for work on the illustrations and photographs and Rebecca Johnson for document preparation.

#### References

1. L.A. Rosocha, J.A. Hanlon, J. McLeod, M. Kang, B.L. Kortegaard, M.D. Burrows, and P.S. Bowling, "Aurora Multikilojoule KrF Laser System Prototype for Inertial Confinement Fusion", *Fusion Technology*, **11**, 497(1987).
2. J.A. Hanlon and J. McLeod, "The Aurora Laser Optical System," *Fusion Technology*, **11**, 635 (1987).
3. J. McLeod, "Output Optics for Aurora: Beam Separation, Pulse Stacking, and Target Focusing," *Fusion Technology*, **11**, 654 (1987).
4. G.W. York Jr., S.J. Czuchlewski, L.A. Rosocha, and E.T. Salasky, "Performance of the Large Aperture Module of the Aurora Krypton Fluoride Laser System," *Digest of Technical Papers CLEO '85*, p. 188 (1985).
5. S.J. Czuchlewski, G.W. York, L.A. Rosocha, and B.J. Krohn, "A Large-Aperture 10-kJ KrF Laser," unpublished manuscript (1986).

6. R. Kristal, L.S. Blair, M.D. Burrows, D.C. Cartwright, P.D. Goldstone, D.P. Greene, J.A. Hanlon, A. Hauer, M. Kang, B.L. Kortegaard, J. McLeod, W.C. Mead, E.A. Rose, and L.A. Rosocha, "Aurora Status and Plans," Proceedings of the 8th International Workshop on Laser Interaction and Related Plasma Phenomena, Monterey, CA, October, 1987, to be published.
7. S.J. Thomas, K.W. Hosack, L.J. Lopez, I.J. Bigio, and N.A. Kurnit, "Improved Performance of the Aurora Front End with the Use of a Phase-Conjugate Mirror," submitted to CLEO '88 (1987).
8. L.A. Rosocha and K.B. Riepe, "Electron-Beam Sources for Pumping Large Aperture KrF Lasers," Fusion Technology, 11, 576 (1987).
9. A.M. Hunter II and R.O. Hunter Jr., "Bidirectional Amplification with Nonsaturable Absorption and Spontaneous Emission," IEEE J. Quantum Electron., QE-17, 1879 (1981).
10. D.P. Greene, Los Alamos National Laboratory, unpublished results (1987).
11. E.A. Rose, "Generation of Ninety-Six Angularly Multiplexed KrF Beams at Aurora," Proceedings CLEO '87, p. 110 (1987).
12. B.L. Kortegaard, "Pac-Man, A Precision Alignment Control System for Multiple Laser Beams, Self-Adaptive through the Use of Noise," Fusion Technology, 11, 671 (1979).
13. J.A. Hanlon, "Optical System," in L.A. Rosocha, J.A. Hanlon, and S.J. Thomas, "Chemical and Laser Sciences Annual Report, 1987, Aurora Project: Construction and Integration of a Multikilojoule KrF Laser System Prototype for Inertial Confinement Fusion," unpublished LANL report (1987).

#### DISCLAIMER

This report was prepared as an account of work sponsored by an agency of the United States Government. Neither the United States Government nor any agency thereof, nor any of their employees, makes any warranty, express or implied, or assumes any legal liability or responsibility for the accuracy, completeness, or usefulness of any information, apparatus, product, or process disclosed, or represents that its use would not infringe privately owned rights. Reference herein to any specific commercial product, process, or service by trade name, trademark, manufacturer, or otherwise does not necessarily constitute or imply its endorsement, recommendation, or favoring by the United States Government or any agency thereof. The views and opinions of authors expressed herein do not necessarily state or reflect those of the United States Government or any agency thereof.