

Rail Gun Program

DO NOT CIRCULATE

PERMANENT RETENTION

REQUIRED BY CONTRACT

University of California



LOS ALAMOS SCIENTIFIC LABORATORY

Post Office Box 1663 Los Alamos, New Mexico 87545

Edited by
Betty Leffler

Photocomposition by
Barbara J. Velarde

DISCLAIMER

This report was prepared as an account of work sponsored by an agency of the United States Government. Neither the United States Government nor any agency thereof, nor any of their employees, makes any warranty, express or implied, or assumes any legal liability or responsibility for the accuracy, completeness, or usefulness of any information, apparatus, product, or process disclosed, or represents that its use would not infringe privately owned rights. Reference herein to any specific commercial product, process, or service by trade name, trademark, manufacturer, or otherwise, does not necessarily constitute or imply its endorsement, recommendation, or favoring by the United States Government or any agency thereof. The views and opinions of authors expressed herein do not necessarily state or reflect those of the United States Government or any agency thereof.

LA-8669-MS

UC-38

Issued: December 1980

Rail Gun Program

C. M. Fowler
D. R. Peterson



RAIL GUN PROGRAM

by

C. M. Fowler and D. R. Peterson

ABSTRACT

Rail guns are devices that drive projectiles by electromagnetic forces. Ultimate projectile speeds therefore are not limited by hydrodynamic velocities, as is the case with conventional guns. This report describes the Los Alamos National Laboratory two-phase rail gun program; one phase is being carried out with Lawrence Livermore National Laboratory. In both phases, explosively driven flux compression generators (FCGs) are used to supply power to the guns. In the Los Alamos phase, part of the gun itself is explosively compressed and thus serves as a second-stage FCG.

Factors affecting gun performance and projectile acceleration and integrity are discussed. The first experiment in the joint phase of the programs is described. Here, a 12.7-mm lexan cube was accelerated to a speed of about 3 km/s in a 0.9-m-long gun by currents reaching nearly 600 kA over a time of several hundred microseconds. Although the projectile was stressed to several times its static yield strength during acceleration, it was recovered intact.

I. INTRODUCTION

Members of Los Alamos National Laboratory Groups M-6 and WX-4 are engaged in a modest two-phase rail gun program. One phase is a collaborative effort with a team from Lawrence Livermore National Laboratory; the other is solely a Los Alamos project. In both phases, explosive flux compression generators designed at Los Alamos are used as external power supplies to drive the guns. In the Los Alamos phase, the guns, referred to as integral rail guns, will be designed so that the rails also can serve as flux compression generator components. Thus the gun itself will be a second-stage flux compression generator.

Principles of rail gun operation are described in some detail in Sec. II because the approach is relatively new at Los Alamos. Development and testing of the strip generator used so far for the external power supply are discussed in Sec. III.

Section IV is devoted to a discussion of a recent successful test in the joint Los Alamos-Livermore program. Requirements for two kinds of rail gun devices are discussed briefly in Sec. V, and a short discussion of the Los Alamos integral rail gun project is given in Sec. VI.

II. THE RAIL GUN

Rail guns of various kinds have been around for at least 20 years. However, almost all rail guns under study today are built along the lines of those used by R. A. Marshall¹ and his collaborators, whose successful work is mainly responsible for the recent resurgence of interest in the field. Figure 1 shows the basic components of a rail gun. The gun's square bore is bounded by upper and lower parallel conducting rails, separated by insulating side walls. Most of the projectiles fired successfully to date have been lexan cubes.

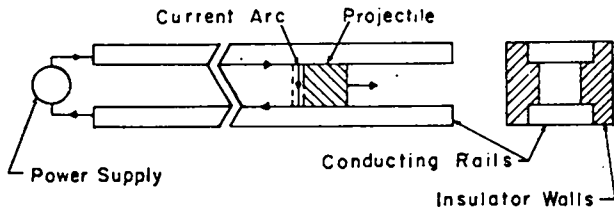

Fig. 1.

Side and end views of a square-bore rail gun. Arrows from the power supply show the current path, including the plasma arc region responsible for driving the projectile. Here, the projectile has moved well down the gun bore.

Initially, the projectile is placed in the gun breech, and a thin metallic fuse is placed between the rails near the projectile's rear face. Usually, a thin shock-mitigating insulator (ablator) is taped to this face. When the power supply is turned on, the metallic fuse quickly vaporizes, and a current arc forms behind the ablator. With some restrictions mentioned later, the resulting force on the projectile can be written as

$$F = \frac{1}{2} \frac{dL_g}{dx} I^2$$

$$\equiv \frac{1}{2} L' I^2 \quad (1)$$

where I is the current flowing through the system, L_g is the rail inductance, and x is the projectile position in the gun. For a square bore, L' , the inductance per unit length, is approximately constant and about $0.5 \mu\text{H/m}$. Its precise value depends somewhat on the thickness of the rails; the current skin depth, which can vary during a shot; and the presence of nearby conductors. (When the entire rail gun assembly is potted and placed inside a metal pipe for strength, L' may be reduced significantly.)

Rail gun power sources have included capacitor banks, flux compression generators, and inductive storage coils. Marshall pioneered use of the coils. He used the large Canberra homopolar generator to load an intermediate inductive store, which then was switched into the rail gun. The time constant of this system was long enough to provide nearly constant current during projectile acceleration.

Under Marshall's conditions of nearly constant I and L' , the force F , acceleration a , and pressure P on a projectile of mass M and cross section A (bore cross section) also are approximately constant.

$$a = F/M$$

$$= L'I^2/2M \quad (2)$$

$$P = F/A$$

$$= L'I^2/2A \quad (3)$$

With constant acceleration, we obtain the usual relations linking projectile velocity v , distance traveled s , and time t .

$$v = at$$

$$s = at^2/2$$

$$= vt/2 \quad (4a)$$

and

$$v = \sqrt{2as} \quad (4b)$$

To get a feeling for the magnitudes involved, we consider some data obtained by Marshall's group. A 12.7-mm (0.5 in.) cube of lexan (weight about 3 g) was accelerated to a velocity of 5.9 km/s in a time of order 1.9 ms. The gun was 5 m long, L' was about $0.4 \mu\text{H/m}$, and the average current was about 250 kA. From Eqs. (1), (2), and (3), we find that

$$F = (0.5)(0.4 \times 10^{-6})(2.5 \times 10^5)^2$$

$$= 1.25 \times 10^4 \text{ N}$$

$$= 1.25 \times 10^9 \text{ dyn} \quad ,$$

$$a = F/m$$

$$= 4.2 \times 10^8 \text{ cm/s}^2 \quad ,$$

and

$$P = F/A$$

$$= 1.25 \times 10^9 / (1.27)^2$$

$$= 7.8 \times 10^8 \text{ dyn/cm}^2$$

$$= 11\,500 \text{ psi} \quad .$$

The velocity and time calculated from Eqs. (4b) and (4a) are 6.4 km/s and 1.5 ms.

Although these values are in reasonable agreement with experiment and give some confidence in the use of the formulas for predicting other rail gun configurations, several uncertainties must be investigated. For example, at very high projectile speeds, friction forces between the projectile and rails may be serious, or the current arc may try to form ahead of the projectile. The latter phenomenon has not been observed to date. Normally the gun bores are evacuated to minimize gas pressure and ionization in front of the projectiles. Perhaps higher vacuums than those presently achieved (~ 1 micron) will ultimately be required.

In addition, some projectiles may have upper pressure limits; if they are subjected to pressures higher than these limits, they probably will break up. If the pressure limits exist, the acceleration allowed for these projectiles is limited, and both longer guns and longer acceleration times will be required to achieve a given velocity. Consequently, considerable effort will be expended in the study of projectile failure mechanisms with the aim of developing tougher projectiles.

Proper rail design is also of paramount importance. Pressures comparable to those on the projectile will separate and compress the rails, flux will penetrate the rails, and the rails will become heated. All of these factors lead to losses that increase with time. These points as well as others common to all rail gun designs have been discussed by Hawke and Scudder.²

A short analysis of a flux compressor driven rail gun leads to reconsideration of Eq. (1). The electrical components that characterize the overall rail gun system (Fig. 2) include the variable inductance L of the explosively driven flux compressor, the circuit resistance R , the source or waste inductance I_0 , and the variable rail gun inductance L_g . Voltages across the circuit components when a current I is flowing give

$$\frac{d}{dt} (LI) + IR + I_0 \frac{dI}{dt} + \frac{d}{dt} (L_g I) = 0 \quad (5)$$

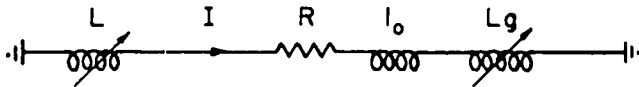

Fig. 2.

The circuit of a generator-powered rail gun system. Included are variable inductors for the generator and the rail gun, a stray inductance term, and resistance. I is the current flowing through the system.

Multiplication of Eq. (5) by I after some terms are rearranged yields

$$\frac{d}{dt} \left(\frac{1}{2} LI^2 \right) + \frac{1}{2} I^2 \frac{dL}{dt} + I^2 R + \frac{d}{dt} \left(\frac{1}{2} I_0 I^2 \right) + \frac{d}{dt} \left(\frac{1}{2} L_g I^2 \right) + \frac{1}{2} I^2 \frac{dL_g}{dt} = 0 \quad (6)$$

The first, fourth, and fifth terms of Eq. (6) represent power delivered to store energy in the circuit inductances; $I^2 R$ is power delivered to the circuit resistance; $I^2 L/2$ is power required to change the generator inductance; and $I^2 L_g/2$ is power required to change the rail gun inductance. Note that \dot{L} is negative, and the generator power terms thus supply the energy to the remaining circuit components.

Implicit in Eq. (1) is the assumption that the rail gun inductance changes only with projectile position x . In this case the power required to change L_g can be written as

$$\begin{aligned} P_g &= \frac{1}{2} I^2 \frac{dL_g}{dt} \\ &= \frac{1}{2} I^2 \frac{dL_g}{dx} \cdot \frac{dx}{dt} \\ &= \frac{1}{2} I^2 L'_g v_p \\ &= F v_p \end{aligned} \quad (7)$$

If the projectile is the only moving part of the gun, $I^2 L'_g/2$ is the force on the projectile. However, some care must be used in applying Eq. (1). For example, if the rails separate as time goes on (that is, as x increases) part of P_g must accommodate this change.

A more sophisticated derivation of Eq. (1) is to equate the force on the projectile to the force exerted on the current arc plasma (the integral of $\vec{j} \times \vec{B}$ over the plasma arc). The difficulty here is to obtain the actual current distribution. However, under somewhat idealized conditions, Eq. (1) is obtained from this treatment. In the meantime, we accept this equation provisionally for extrapolation purposes because of approximate experimental confirmation at presently achieved acceleration levels.

III. STRIP GENERATOR DEVELOPMENT

Strip generators, such as those described by Fowler et al.,³ were selected to be external rail gun power sources for the present work because they can deliver large currents for long times—prerequisites for most rail gun applications. The strip generator consists of long parallel strips of copper, one of which is overlaid with explosive sheets; an input block for capacitor bank input leads; and an output block for connections to the load. Figure 3a shows the kind of generator we have tested and used to date. The copper strips are 2.4 m long, 57 mm wide, and 1.6 mm thick, and the separation between them is 51 mm. Two layers of C-8 Detasheet explosive, 51 mm wide, are placed over the upper copper strip. To minimize expansion of generator components from magnetic forces, steel ballast bars, 50.8 mm wide by 12.7 mm to 25.4 mm thick, are laid on top of the Detasheet explosive and directly under the bottom copper strip. The wedge-shaped input and output blocks are cut from 50.8-mm square brass bar stock and then drilled and tapped individually to accommodate cable input header attachments and to make output connections to the various loads tested.

After flux from a capacitor bank is introduced into the generator and the load, the detonator is fired. The input slot is closed to trap the flux, and detonation proceeds down the Detasheet strips. When the top plate is driven into the bottom plate, it pushes the flux into the load.

Several tests were fired with this basic configuration and different kinds of loads. The last test used a load having some characteristics of a 1-m-long rail gun, as shown in Fig. 3b. Brass rails, 19 mm by 19 mm by 0.9 m long, were connected to the output block and the bottom plate and were spaced 12.7 mm apart. Steel ballast bars, 12.7 mm by 50.8 mm, were placed on top of the upper rail and beneath the lower rail. Electrical insulation extended only 0.46 m, or halfway down the "bore." One

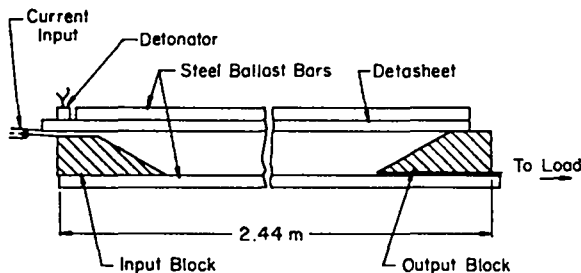

Fig. 3a.
A strip generator.

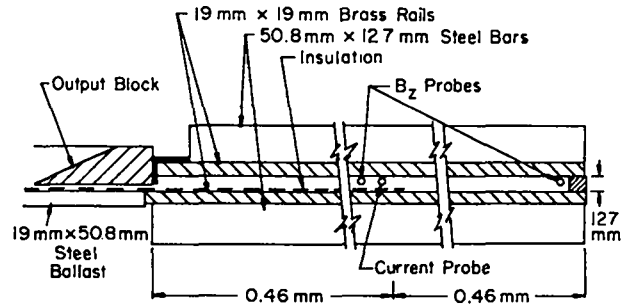

Fig. 3b.
A simulated rail gun load connected to the output of a strip generator. The heavy brass rails are ballasted with steel bars 50.8 mm thick. Insulation extends only halfway (0.46 m) down the bore.

B_z magnetic-field measuring probe was placed in the insulated section, as was a current-measuring (Rogowski) probe. Another B_z probe was placed at the end of the bore. An electrical breakdown between rails in the uninsulated section would cause a difference in the signals from the two B_z probes. In the actual shot, the two B_z probe signals were essentially identical. The current record obtained for this shot is shown in Fig. 4. During generator burn, the current gradually increased and was nearly 0.7 MA at generator burnout. After burnout, the current decayed because of flux penetration into the rails and expansion of the bore.

Flash x-radiographs (Figs. 5a and b) were taken of the assembly near the output block-load coil connection. Figure 5a shows the pretest setup, and Fig. 5b shows the same region about 25 μ s before generator burnout. The lead brick (102 mm thick) seen at the top of both

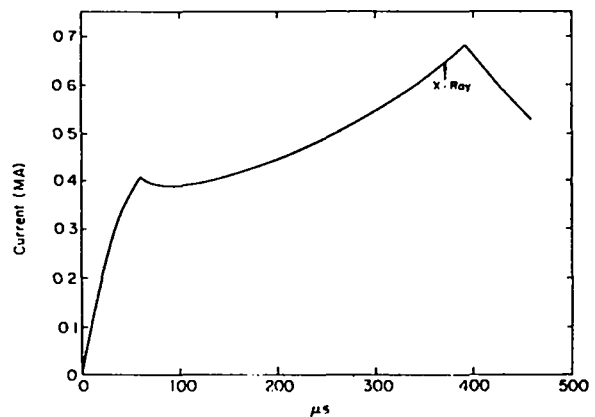

Fig. 4.
Current vs time for a simulated rail gun load. A flash x-radiograph was taken at the generator-load junction shortly before generator burnout.



Fig. 5a.

Flash x-radiograph of the setup near the load-generator connection for the simulated rail gun test.

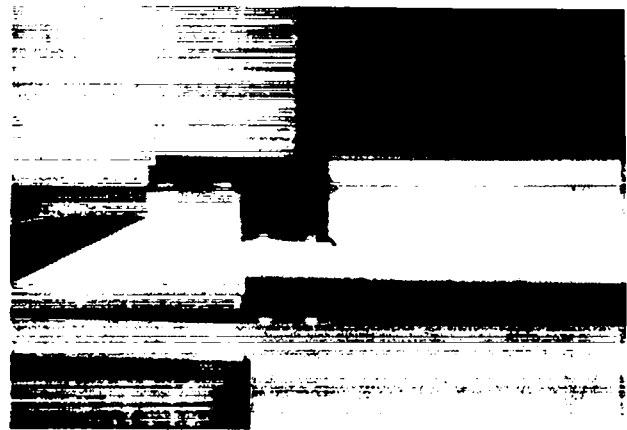

Fig. 5b.

Flash x-radiograph of the same region taken just before generator burnout.

x-radiographs supplemented the steel ballast bars and effectively prevented upward displacements of the generator components. In spite of the heavy ballasting over other components, their displacements are quite apparent. The gun bore separation has increased from its initial 12.7 mm to 25 mm. Prevention of significant rail displacement could be a major problem, particularly for guns that are to be used repetitively. The problem has been solved to date by encapsulating the rails in pipes of sufficient hoop strength to prevent significant rail displacement. Ballasting is adequate for the present class of external generators, but when larger currents are required for longer times some kind of encapsulation also may be required for the generators.

IV. LOS ALAMOS-LIVERMORE RAIL GUN SHOT

A strip generator was used recently to power a 0.91-m-long rail gun in a shot fired at Los Alamos's Ancho Canyon flux compression facility. The strip generator is similar to the one described in Sec. III. The rail gun was designed and built at Livermore.

Figure 6 shows several components of the assembly. The gun bore was 12.7 mm by 12.7 mm. The rails and insulating walls forming the bore were potted in a glass epoxy mixture, and the potted assembly, in turn, was contained in an aluminum pipe. Flanges on the pipe ends allowed vacuum-tight connections of the gun rails to the generator output on the left, and to a cylindrical diagnostic terminal container on the right. The projectile was a 12.7-mm lexan cube to which an 0.80-mm-thick,

12.7-mm-square ablator was taped. The projectile with ablator was placed in the gun breech (near the generator input) just after the copper fuse (12.7 mm high, 10.2 mm wide, 0.51 mm thick). The vacuum seal at the gun output end was effected by a Mylar window, 102-mm in diam by 0.13 mm thick, secured to the diagnostic container. Electrical diagnostics included a Rogowski current probe, muzzle and breech voltage dividers, and six magnetic pickup probes located at various distances down the gun. The breech voltage divider and the magnetic pickup probes were connected inside the diagnostic container to the cable terminals projecting through the container wall. Seen behind the diagnostic container and to the right is a cassette holding x-ray film, with which we hoped to obtain a picture of the projectile in free flight by flash x-radiography. Also seen in the figure is a rag-stuffed garbage can placed beyond the cassette to catch the projectile.

For a first test, the results were quite satisfactory. At the suggestion of R. A. Marshall, a consultant to the project who also supplied the projectile ablator, the shot was fired at considerably less initial current than originally planned to improve the odds against fracturing the projectile. Figure 7 shows the current record for the shot, and Fig. 8 is the flash x-radiograph. In Fig. 8, the lexan cube and ablator have separated, and both are somewhat rotated. The lexan cube was recovered intact. Most of the ablator was also recovered.

The maximum projectile velocity was estimated from the various probe records and the time at which the x-radiograph was taken at about 3 km/s. This velocity was achieved in a gun only 0.91 m long. Also, the lexan



Fig. 6.
A 0.91-m-long rail gun, a film cassette, and a projectile catcher.

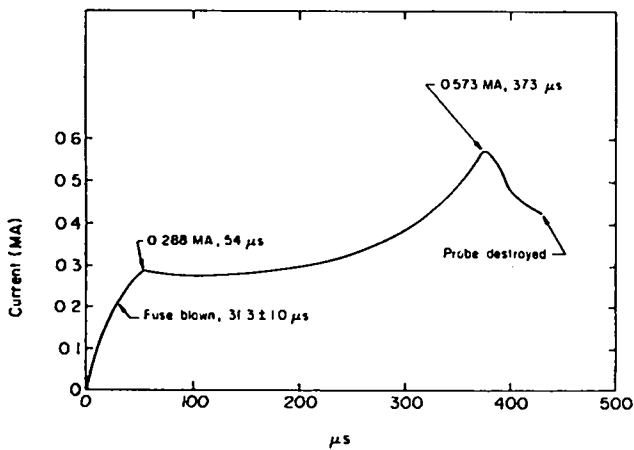

Fig. 7.
Record of current vs time obtained from the Los Alamos-Livermore rail gun shot.

projectile was subjected to pressures three to four times higher than those under which such projectiles had remained intact. We tentatively attribute this fortunate result to the slow rate at which the current increased to its large peak value (nearly 0.6 MA). If other tougher projectile materials exhibit a similar capacity to be overstressed, a significant advance in rail gun technology can be expected.

V. RAIL GUN APPLICATIONS

Figure 9 shows a series of curves that relate projectile velocity, time, gun length, mass, and average gun current. The acceleration a , assumed to be constant, is given by Eq. (2). A gun inductance of $0.4 \mu\text{H/m}$, about the value measured for Marshall's guns, has been



Fig. 8.

A flash x-radiograph shows the separated lexan projectile and ablator in free flight.

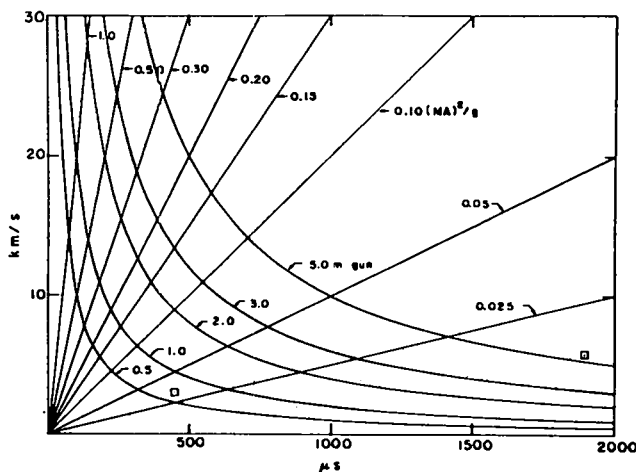

Fig. 9.

Curves of constant acceleration and distance plotted on velocity, time coordinates for idealized rail guns.

assumed. Velocity and time are related linearly for constant acceleration. The straight lines through the origin show this relationship for various values of a , or from Eq. (2), for various values of I^2/M . The hyperbolas are lines of constant distance s (gun length) given by $vt = 2s$.

The two points enclosed by squares in Fig. 9 are experimental points. Marshall obtained a velocity of 5.9 km/s in about 1900 μ s with a gun about 5 m long. As noted on the figure, the (v,t) point lies quite close to the 5-m curve. The value of I^2/M , about 0.015, corresponds to an average current of some 200 kA for a projectile of about 3-g mass. The point at 3 km/s and 450 μ s was obtained from the Los Alamos-Livermore shot. Here, I^2/M is about 0.035, and I should average about 320 kA. (This calculated value should be raised about 15%, because L' for this gun was only about 0.3 μ H/m.) The predicted acceleration length is only about 0.7 m. This length is thought to be about right, as it is consistent with other shot diagnostics. The power supply was actually designed for a full 0.91-m gun. However, as noted earlier, the generator loading was reduced at Marshall's suggestion. Consequently, the current delivered by the generator was insufficient to continue substantial projectile acceleration down the entire barrel. In other words, we think that the projectile coasted the last 0.2-0.3 m. The agreement of experiment with the idealized curves of Fig. 9 is sufficiently good that cautious extrapolation to other rail gun conditions appears reasonable.

At present there appear to be two regions of major interest: acceleration of a few grams to velocities in excess of 10 km/s for equation-of-state work, and acceleration of 100- to 300-g projectiles to velocities of 2-5 km/s.

There are, of course, ranges of gun length, average current, and time in which to accelerate a projectile to a given velocity. For example, a 3-g projectile would be accelerated to a velocity of some 15 km/s in a 3-m gun by an average current of 770 kA over a time of about 400 μ s (as determined from the intersection of the $I^2/M = 0.2$ line with the $s = 3$ m curve). At the other extreme, a 200-g projectile could be accelerated to 3 km/s under the following conditions.

Gun Length (m)	Average Current (MA)	Time (μ s)
2	1.55	1300
1	2.2	670
0.5	3.0	330

None of these conditions are impossible to meet from the standpoint of the flux compression generators. More massive strip generators, perhaps incorporating containment features other than mere inertial ballasting, may be required for the longer time pulses. Booster generators no doubt will be required to load the main drive generators needed to accelerate 200-g projectiles. Although the rail and projectile limitations are not considered here, it is clear that they play major roles in setting the gun designs.

VI. INTEGRAL RAIL GUN PROGRAM

The similarity of the rail gun and strip generator geometries led to the concept of treating the rail gun as a strip generator. In principle this can be done by laying a strip of explosive on either or both of the rails shown in Fig. 1. Thus, if the external power source were also a flux compression generator, the rail gun itself would serve as a second-stage generator. Peterson and Fowler⁴ have analyzed projectile motion under these conditions. The analysis is idealized in that it does not allow for any flux losses. Its major finding is that projectile velocities can exceed the explosive detonation velocity. Without flux losses, the magnetic fields and currents, and thus the forces on the projectile, get very large as the detonation front approaches the projectile. The analysis shows that as detonation proceeds the detonation front closes upon the accelerating projectile up to a minimum separation distance between front and projectile. At this time the projectile has accelerated to detonation velocity; from then on its velocity increases beyond detonation velocity. In reasonably long guns, projectile velocities of order twice detonation velocity have been calculated.

Although achievement of projectile velocities approaching 20 km/s by means of an integral rail gun would indeed be significant in itself, the most exciting prospect rests on the possibility of producing almost unlimited effective detonation velocities by phased initiation of the explosive. Initiation can be phased by initiating the explosive with an externally driven flyer plate placed originally at the appropriate angle to the explosive strip.

There are other significant advantages to this approach. Because the rails are wiped out continuously, any given portion of the rails is not exposed for a very long time to the disruptive effects of large currents; that is, to rail deformation stresses, flux penetration, and

heating. In addition, the magnetic energy stored in the rail cavity is correspondingly smaller.

There are potential problems to the integral rail gun, aside from those facing more conventional guns. For instance, if flux losses are excessive, the detonation front can overtake the projectile. Also, jets formed at the rail contact region might strike the projectile or produce additional current paths and result in undesirable flux-trapping.

There could be additional problems associated with the explosives, both from undue damage to the uninitiated explosive if it is subjected to large mechanical stresses, and from lack of energy content if the efficiency of conversion to projectile kinetic energy is too low. Somewhat paradoxically most of these problems are expected to be less serious at very large phased velocities.

To date, several integral rail gun sections have been constructed, mainly to evolve simpler designs and to allow for incorporation of diagnostics. Preliminary shots have been fired (without current) to perfect techniques for studying the interaction of the explosively driven rails. Engineering drawings are nearly finished for two complete gun sections, the one to be potted in an aluminum tube and the other to be overwound with fiber glass and epoxy. Methods of potting the gun with explosives in place have been discussed with Los Alamos Group WX-3 consultants and appear to present no serious difficulties. Discussions with Los Alamos Group CMB-6 personnel have led to several ideas for better projectiles, which will be fabricated and tested. Finally, consideration has been given to improving diagnostic coverage. In particular, we hope to obtain multiple flash x-ray coverage of the projectiles in free flight and to improve the quality of the magnetic pickup probe signals that monitor projectile motion inside the gun.

REFERENCES

1. S. C. Rashleigh and R. A. Marshall, "Electromagnetic Acceleration of Macroparticles to High Velocities," *J. Appl. Phys.* 49(4), 2540 (1978).
2. R. S. Hawke and J. K. Scudder, "Magnetic Propulsion Railguns: Their Design and Capabilities," Lawrence Livermore National Laboratory preprint UCRL-82677 (1979).

3. C. M. Fowler, R. S. Caird, W. B. Garn, and D. B. Thomson, "The Los Alamos Flux Compression Program from Its Origin," in *Proc. Conf. Megagass Magnetic Field Generation by Explosives and Related Experiments*, H. Knoepfel and F. Herlach, Eds., (Euratom, Brussels, 1966) p. 13.
4. D. R. Peterson and C. M. Fowler, "Rail Gun Powered by an Integral Explosive Generator," in "Proc. Impact Fusion Workshop," A. T. Peaslee, Jr., Comp., Los Alamos National Laboratory report LA-8000-C (August 1979) pp. 237-244.

Printed in the United States of America
 Available from
 National Technical Information Service
 US Department of Commerce
 5285 Port Royal Road
 Springfield, VA 22161
 Microfiche \$3.50 (A01)

Page Range	Domestic Price	NTIS Price Code	Page Range	Domestic Price	NTIS Price Code	Page Range	Domestic Price	NTIS Price Code	Page Range	Domestic Price	NTIS Price Code
001-025	\$ 5.00	A02	151-175	\$11.00	A08	301-325	\$17.00	A14	451-475	\$23.00	A20
026-050	6.00	A03	176-200	12.00	A09	326-350	18.00	A15	476-500	24.00	A21
051-075	7.00	A04	201-225	13.00	A10	351-375	19.00	A16	501-525	25.00	A22
076-100	8.00	A05	226-250	14.00	A11	376-400	20.00	A17	526-550	26.00	A23
101-125	9.00	A06	251-275	15.00	A12	401-425	21.00	A18	551-575	27.00	A24
126-150	10.00	A07	276-300	16.00	A13	426-450	22.00	A19	576-600	28.00	A25
									601-up	†	A99

†Add \$1.00 for each additional 25-page increment or portion thereof from 601 pages up.

LASL
REPORT LIBRARY

MAR 24 1961

RECEIVED