

LA-3562

C.3

CIC-14 REPORT COLLECTION
**REPRODUCTION
COPY**

LOS ALAMOS SCIENTIFIC LABORATORY
of the
University of California
LOS ALAMOS • NEW MEXICO

**Distribution of Americium Between
Liquid Plutonium and a Fused Salt.
Evidence for Divalent Americium**

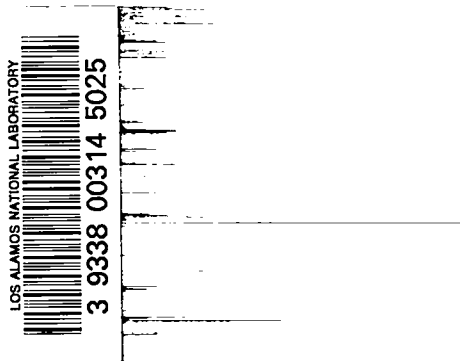

UNITED STATES
ATOMIC ENERGY COMMISSION
CONTRACT W-7405-ENG. 36

LEGAL NOTICE

This report was prepared as an account of Government sponsored work. Neither the United States, nor the Commission, nor any person acting on behalf of the Commission:

A. Makes any warranty or representation, expressed or implied, with respect to the accuracy, completeness, or usefulness of the information contained in this report, or that the use of any information, apparatus, method, or process disclosed in this report may not infringe privately owned rights; or

B. Assumes any liabilities with respect to the use of, or for damages resulting from the use of any information, apparatus, method, or process disclosed in this report.

As used in the above, "person acting on behalf of the Commission" includes any employee or contractor of the Commission, or employee of such contractor, to the extent that such employee or contractor of the Commission, or employee of such contractor prepares, disseminates, or provides access to, any information pursuant to his employment or contract with the Commission, or his employment with such contractor.

This report expresses the opinions of the author or authors and does not necessarily reflect the opinions or views of the Los Alamos Scientific Laboratory.

LA-3562
UC-4, CHEMISTRY
TID-4500

LOS ALAMOS SCIENTIFIC LABORATORY
of the
University of California
LOS ALAMOS • NEW MEXICO

Report written: May 17, 1966

Report distributed: December 1, 1966

Distribution of Americium Between
Liquid Plutonium and a Fused Salt.
Evidence for Divalent Americium

by

L. J. Mullins
A. J. Beaumont
J. A. Leary



ABSTRACT

The distribution of Am between liquid Pu metal and a fused salt of NaCl-KCl containing PuCl₃ has been studied at 698, 730, and 775°C. over a PuCl₃ mole fraction range of 6 x 10⁻³ to 2 x 10⁻². The distribution data are consistent with the following equation

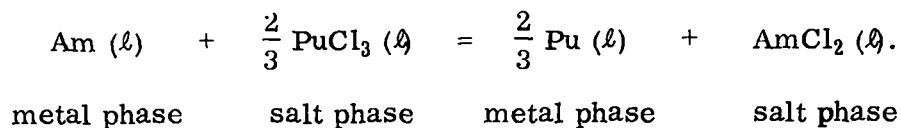

From the temperature dependence of the equilibrium constant, a value of -3.5 kcal. was obtained for ΔH° for the above reaction.

ACKNOWLEDGMENTS

The authors are indebted to R. L. Nance for the PuCl₃, to K. W. R. Johnson for the Am, to Group CMB-1 for radiochemical analyses, and to G. M. Campbell who assisted with the computer programming.

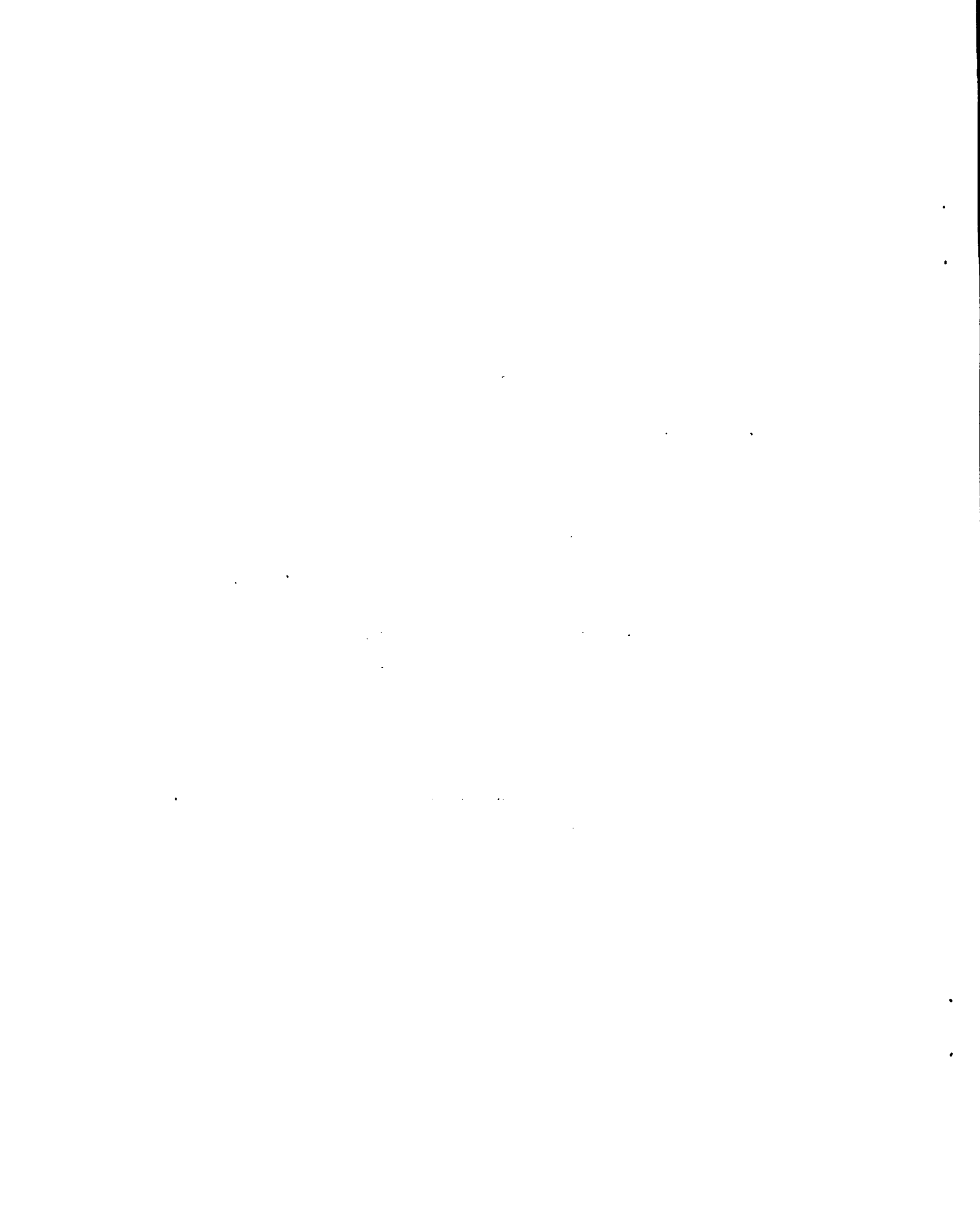

CONTENTS

	<u>Page</u>
Abstract	3
Acknowledgments	3
Introduction	7
Experimental	7
Equipment	7
Procedure	8
Preparation of Materials	10
Results and Discussion	10
References	19
Appendix	20

TABLES

1. Distribution of Am and Pu at 698 ^o C.	11
2. Distribution of Am and Pu at 730 ^o C.	12
3. Distribution of Am and Pu at 775 ^o C.	13
4. Equilibrium Constants at 730 ^o C. for	
$\text{Am} + \frac{y}{x} \text{PuCl}_x = \text{AmCl}_y + \frac{y}{x} \text{Pu}$	15
5. Equilibrium Constants for the Reaction	
$\text{Am} + \frac{2}{3} \text{PuCl}_3 = \text{AmCl}_2 + \frac{2}{3} \text{Pu}$	18

ILLUSTRATIONS

<u>Figure</u>	<u>Page</u>
1. Equipment for Distribution Studies	9
Plots of K'/K'_{\max} vs. wt. % Pu in Salt, 730°C., for the Stoichiometry	
2. PuCl ₁ and AmCl ₁ through AmCl ₆	21
3. PuCl ₂ and AmCl ₁ through AmCl ₆	22
4. PuCl ₃ and AmCl ₁ through AmCl ₆	23
5. PuCl ₄ and AmCl ₁ through AmCl ₆	24
6. PuCl ₅ and AmCl ₁ through AmCl ₆	25
7. PuCl ₆ and AmCl ₁ through AmCl ₆	26

INTRODUCTION

Americium-241 grows into Pu at the rate of about 15 p. p. m. per month as the result of β decay of Pu-241. The chemistry of trace amounts of Am in molten Pu-molten salt systems has been discussed in earlier publications. ^(1, 2) When PuCl₃ is equilibrated at high temperature with Am dissolved in liquid Pu, the Am is preferentially oxidized and concentrates in the molten salt phase.

This report summarizes the results of a study of the heterogeneous equilibrium between Am and Pu in liquid metal-molten salt systems.

EXPERIMENTAL

Equipment

The equipment used for the distribution studies is shown in Fig. 1. The salt and metal phases were contained in a Ta crucible and were mixed by a motor driven Ta stirrer. The crucible was positioned in a stainless steel furnace tube which was heated by a Hevi-Duty Electric Co. tube furnace, Model M-5012. The upper furnace tube head contained seals and fittings for a stirrer, six sampling tubes, two Ta tubes which served as thermocouple sheaths, a gas-vacuum line, and a motor support rod. The bottom furnace tube cover contained a fitting for an Ar line. Temperatures were measured with a chromel alumel thermocouple immersed in the liquid metal phase and were recorded with a Brown Honeywell recorder. The thermocouple was protected by a Ta sheath. The temperature was controlled by a Wheelco Potentiostat which was activated by a thermocouple positioned in the

thermocouple well shown in Fig. 1. The atmosphere in the furnace tube was Ar which was purified by passing welding grade Ar (99.998% purity) through a U chip furnace at 700°C.

Procedure

Approximately 700 g. of metal and 280 g. of salt were placed in the Ta cup shown in Fig. 1 and heated to melting. The sampling tubes were positioned 1 in. above the molten salt phase to minimize temperature changes during the sampling process, and the stirrer and thermocouple were lowered into the melt. The controller was set at the desired temperature, and the stirrer was activated. After at least 1 hr. at a constant temperature ($\pm 0.5^\circ\text{C}.$), the stirrer was stopped, and the salt and metal phases were sampled. The metal sample was taken by simply lowering the Ta sampling tube into the metal phase. The salt phase was sampled by lowering an evacuated Ni filter tube into the salt phase and filtering the salt through the Ni frit by pressurizing the furnace to ~ 3 p. s. i. g. Samples of both phases were taken at the same time. The sample tubes were permitted to fill for approximately 3 min. The recorded temperature dropped as much as $4^\circ\text{C}.$ during this 3-min. period. All temperatures listed in the tables are the equilibration temperatures. The tubes were then raised into the cold zone of the furnace tube which resulted in freezing the salt and metal samples. The furnace was then set at a higher or lower temperature or in some cases kept at the same temperature. After temperature equilibrium was again established the mixing of both phases was continued for at least 1 hr. and the sampling process repeated. After three salt and three metal samples had been taken in this manner the furnace was cooled to $480^\circ\text{C}.$ to freeze the metal and salt, and the furnace tube head was replaced with a blank flange. An Ar atmosphere was maintained in the furnace at all times.

The metal samples were removed from the Ta tubes and were pickled in 4M HNO_3 to remove any adherent salt prior to dissolution in 6M HCl . The

- (1) Metal phase
- (2) Salt phase
- (3) Ta crucible, 2-1/2 in. O.D., 2-7/16 in. I.D., 3-1/4 in. tall
- (4) Ni crucible, 2-13/16 in. O.D., 2-11/16 in. I.D., 9-1/2 in. tall
- (5) Thermocouple well, 1/2 in. diam. x 2 in. deep
- (6) Ta stirrer, 1/4 in. O.D. rod, 16 in. long, 3/4 in. diam. impellers spaced 1-1/4 in. apart
- (7) Ni adapter, 9/16 in. wide, 3/4 in. long, 1/2 in. tall
- (8) Ni rod, 1/4 in. O.D., 10 in. tall
- (9) Ni filter tube for salt phase samples, 5/16 in. O.D., 1-1/2 in. tall, 5/16 in. I.D., 1-1/4 in. deep; frit dimensions 5/16 in. O.D., 1/16 in. thick
- (10) Ta rod, 1/8 in. diam., 2-1/2 in. tall
- (11) Ni rod, 1/4 in. diam., 10 in. long
- (12) Ta adapter tube, 3/8 in. O.D., 1/4 in. I.D., 3 in. tall; milled slot 3/16 in. wide, 2 in. tall
- (13) Ta sampling tube for metal phase, 1/4 in. O.D., 1-1/2 in. long; two milled slots 1/8 in. wide, 1/2 in. tall
- (14) Stainless steel furnace tube, 5 in. O.D., 4-3/4 in. I.D., 20 in. long
- (15) Stainless steel pedestal, 9 in. tall
- (16) Stainless steel spacer, 4-1/2 in. O.D., 2-7/8 in. I.D., 3-1/2 in. tall
- (17) Ar inlet port

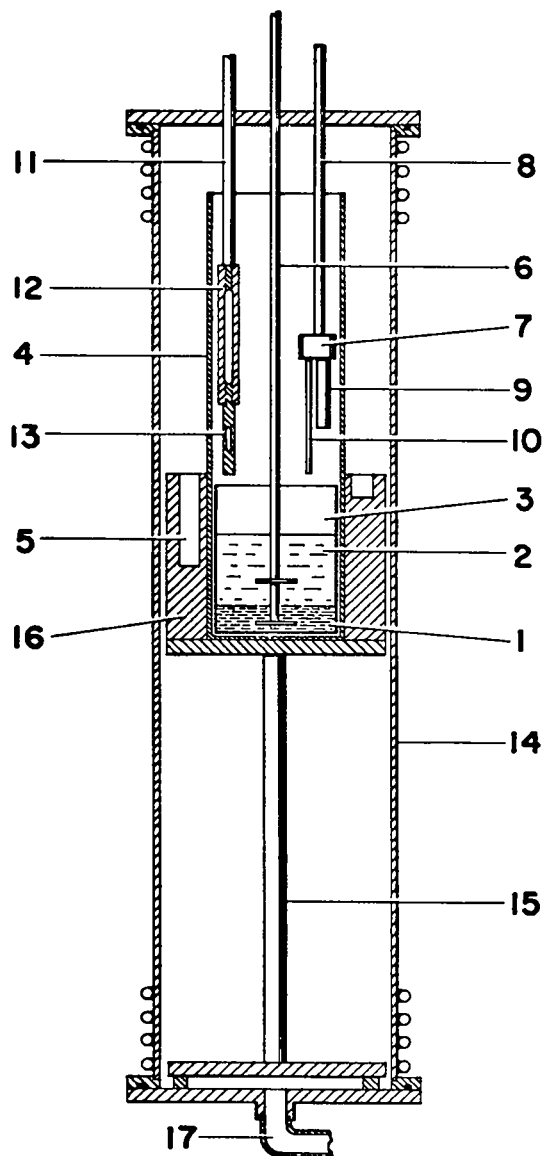

Fig. 1. Equipment for Distribution Studies

salt samples were removed as quantitatively as possible from the Ni tubes and were dissolved in 4M HNO₃. Plutonium and Am were determined radiochemically. (3)

To conduct an experiment at a different temperature or at a different PuCl₃ or AmCl₃ concentration the blank flange was removed from the furnace, the desired amount of salt or metal was added, and the sampling tube head was installed. The results were shown to be reversible with respect to direction of approach of temperature and Pu and Am concentrations (i. e., the same results were obtained when Am was transferred from salt to metal phase or when Am was transferred from metal to salt phase). Equilibrium was achieved in less than 1 hr. at a constant temperature.

Preparation of Materials

NaCl-KCl... An equimolar mixture of the salts was prepared by melting Baker's A. R. grade salts under vacuum.

PuCl₃... The PuCl₃ was prepared by the hydrochlorination of Pu₂(C₂O₄)₃, followed by vacuum distillation of the PuCl₃.

Pu... The Pu was electrorefined grade metal.

Am... The Am metal was obtained by the reduction of Am₂O₃ with La and distillation of the Am. (4)

RESULTS AND DISCUSSION

The results of the distribution experiments at 698, 730, and 775° C. are given in Tables 1, 2, and 3.

The extraction of Am from the metal into the salt phase can be represented by the generalized equation

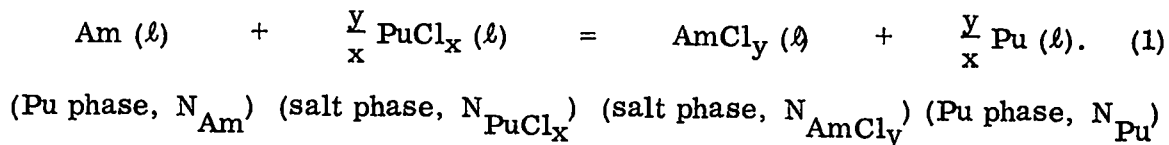

Table 1
 Distribution of Am and Pu at 698°C.
 Salt Phase - Equimolar NaCl-KCl Containing
 Pu and Am

<u>Pu in Salt,</u> wt. %	<u>Am in Salt,</u> wt. % x 10 ²	<u>Am in Metal,</u> wt. % x 10 ³
2.14	6.76	8.32
2.20	6.96	7.87
2.29	6.89	7.56
2.61	7.71	6.92
3.04	7.15	6.08
5.44	8.33	4.89
5.62	7.49	4.31
6.08	8.14	4.42
6.76	8.48	4.39
9.78	7.58	3.38
11.20	8.15	2.99

Table 2

Distribution of Am and Pu at 730°C.
Salt Phase - Equimolar NaCl-KCl Containing
Pu and Am

<u>Pu in Salt,</u> <u>wt. %</u>	<u>Am in Salt,</u> <u>wt. % x 10²</u>	<u>Am in Metal,</u> <u>wt. % x 10³</u>
2.30	6.70	7.23
2.40	6.95	7.57
2.66	7.54	7.43
2.67	7.34	7.36
2.90	7.84	7.37
3.51	8.04	6.81
3.55	7.99	6.84
3.72	8.26	6.35
4.78	12.0	8.41
5.52	8.28	4.84
5.66	7.58	4.83
5.88	8.06	4.86
6.06	7.99	4.83
7.01	6.78	3.72
7.80	8.64	4.40
8.13	7.58	3.96
8.22	8.88	4.71

Table 3

Distribution of Am and Pu at 775^oC.Salt Phase - Equimolar NaCl-KCl Containing
Pu and Am

<u>Pu in Salt,</u> <u>wt. %</u>	<u>Am in Salt,</u> <u>wt. % x 10²</u>	<u>Am in Metal,</u> <u>wt. % x 10³</u>
2.15	6.53	8.34
2.28	6.57	8.17
2.51	7.20	7.42
2.56	6.83	7.44
2.58	6.85	7.34
3.76	10.7	9.05
3.88	10.2	9.01
4.56	11.7	9.38
5.27	8.00	5.40
5.78	7.11	4.68
5.89	5.02	3.73
5.98	7.29	4.70
7.81	7.36	3.89
8.56	6.96	3.82

The equilibrium constant for reaction (1) can be written

$$K = \frac{N_{\text{AmCl}_y}^{\text{N}} N_{\text{Pu}}^{y/x}}{N_{\text{Am}} N_{\text{PuCl}_x}^{y/x}} \frac{\gamma_{\text{AmCl}_y} \gamma_{\text{Pu}}^{y/x}}{\gamma_{\text{Am}} \gamma_{\text{PuCl}_x}^{y/x}}, \quad (2)$$

where N is the mole fraction and γ is the activity coefficient. The metal phase is essentially pure Pu, so that $N_{\text{Pu}} = \gamma_{\text{Pu}} = 1$.

The range of Am and AmCl_y concentrations studied varied

from $\sim 2 \times 10^{-4}$ to $\sim 3 \times 10^{-4}$ for N_{AmCl_y} and

from $\sim 5 \times 10^{-5}$ to $\sim 7 \times 10^{-5}$ for N_{Am} .

Therefore, the activity coefficients of Am and AmCl_y should be essentially constant. Further, to a first approximation the activity coefficient of PuCl_x can be assumed to be nearly constant over the mole fraction range studied, 6×10^{-3} to 2×10^{-2} . This is a reasonable assumption since the activity coefficient of PuCl_3 has been shown to be constant in the LiCl-KCl system over the PuCl_3 mole fraction range 6×10^{-4} to 2×10^{-2} .⁽⁵⁾ Equation (2) can therefore be written

$$K' = \frac{N_{\text{AmCl}_y}^{\text{N}}}{N_{\text{Am}} N_{\text{PuCl}_x}^{y/x}}. \quad (3)$$

With the aid of the IBM 7094 computer, values of K' were calculated for each value of x and y from 1 through 6. Typical results are shown in Table 4. In order to observe which values of x and y gave the most constant

Table 4

Equilibrium Constants at 730°C. for

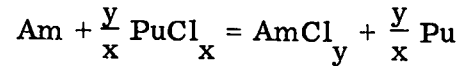

<u>N x 10²</u> <u>PuCl₃</u>	<u>K' x 10² for</u>	
	<u>x = 3, y = 3</u>	<u>x = 3, y = 2</u>
0.658	4.03	0.755
0.688	3.83	0.727
0.764	3.82	0.751
0.767	3.74	0.737
0.836	3.67	0.744
1.02	3.36	0.729
1.03	3.29	0.716
1.08	3.50	0.774
1.41	2.99	0.721
1.64	3.10	0.788
1.69	2.77	0.711
1.76	2.82	0.733
1.82	2.73	0.718
2.13	2.60	0.720
2.39	2.49	0.719
2.50	2.35	0.689
2.53	2.29	0.674

value of K' , the values of K' for any particular x , y set were normalized by dividing each value of K' by the maximum value of K' for that set. The normalized values were then plotted as a function of the weight percent Pu in the salt. A constant value of K' would therefore result in a straight line plot parallel to the y axis and would intersect the x axis at $x = 1.0$. The slope of the curve is sensitive to the ratio of y and x . For example almost identical plots can be expected for $\text{PuCl}_1\text{-AmCl}_1$, $\text{PuCl}_2\text{-AmCl}_2$, $\text{PuCl}_3\text{-AmCl}_3$, $\text{PuCl}_4\text{-AmCl}_4$, $\text{PuCl}_5\text{-AmCl}_5$, and $\text{PuCl}_6\text{-AmCl}_6$.

The 36 plots for the experiments at 730°C . are given in the appendix. The same procedure was used for the 698 and 775°C . data. In all cases the most constant value of K' was obtained for the values ($x = 3$, $y = 2$), ($x = 6$, $y = 4$), and ($x = 5$, $y = 3$).

All previous studies on this type of metal-salt system have shown that trivalent Pu is the only stable Pu ion in equilibrium with Pu metal. Potentiometric measurement in LiCl-KCl have shown that PuCl_3 is the only species stable in the presence of Pu metal. ⁽⁵⁾ Anodic and cathodic efficiency studies in the electrorefining process ⁽¹⁾ have indicated that the electrode reactions are

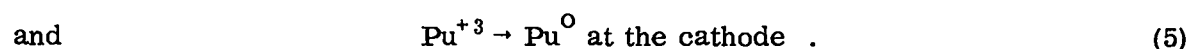
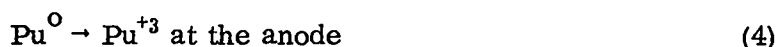

In addition the phase diagram for Pu-PuCl_3 ⁽⁶⁾ gives no evidence of a Pu oxidation state other than +3.

The only x , y set consistent with this information is the set $x = 3$, $y = 2$. Equation (1) can therefore be written as follows for divalent Am:*

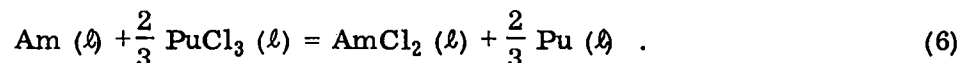

*The conclusion that Am is present in the salt as divalent Am was first reported by Leary and Mullins at the Symposium on Thermodynamics, International Atomic Energy Agency, Vienna, July 22-27, 1965. ⁽⁷⁾

Values of K' for reaction (6) for the experiments at 698, 730, and 775°C. are given in Table 5. The average deviations of K' were $\pm 4.5\%$ at 698°C., $\pm 2.0\%$ at 730°C., and $\pm 4.1\%$ at 775°C. These values approximate the expected experimental deviation of 4%. A plot of $\log K'$ vs. $1/T$ gives a ΔH° for reaction (6) of -3.5 kcal.

Since Am is the homolog of Eu and Eu is known to form divalent salts, the presence of divalent Am in the NaCl-KCl salt is reasonable. Although all attempts to prepare pure Am^{+2} compounds have been unsuccessful, (8) the stabilization of divalent Am in a CaF_2 lattice has been postulated recently by workers at the Lawrence Radiation Laboratory. (9) Single crystals of CaF_2 containing 0.1 - 0.2 wt. % AmF_3 were reduced electrolytically at 600°C. Optical absorption spectra of the crystals at room temperature showed the disappearance of the Am^{+3} lines around 5000 Å and the appearance of broad absorption peaks which were attributed to Am^{+2} .

Table 5

Equilibrium Constants for the Reaction

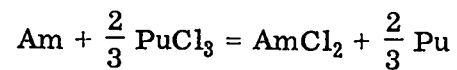

<u>Temp., °C.</u>	<u>K' (Avg. Dev.)</u>
698	77.2 (± 3.5)
730	73.0 (± 1.5)
775	67.6 (± 2.8)

REFERENCES

1. L. J. Mullins, J. A. Leary, A. N. Morgan, W. J. Maraman, "Plutonium Electrorefining," Los Alamos Scientific Laboratory Report LA-2666 (1962).
2. L. J. Mullins, J. A. Leary, "Fused-Salt Electrorefining of Molten Plutonium and Its Alloys by the LAMEX Process," *Ind. Eng. Chem. Process Design and Develop.*, 4, 394 (1965).
3. J. Bubernak, M. S. Lew, G. M. Matlack, "Determination of Americium in Plutonium by Gamma Counting," *Anal. Chem.*, 30, 1759-1762 (1958).
4. K. W. R. Johnson, J. A. Leary, "Preparation of Americium Metal," Los Alamos Scientific Laboratory Report LA-2992 (1963).
5. G. M. Campbell, J. A. Leary, "Thermodynamic Properties of Pu Compounds from EMF Measurements I. Pu Versus Ag in LiCl-KCl Eutectic," Los Alamos Scientific Laboratory Report LA-3399 (1965).
6. K. W. R. Johnson, J. A. Leary, "The Pu-PuCl₃ System," *J. Inorg. Nucl. Chem.*, 26, 103-105 (1964).
7. J. A. Leary, L. J. Mullins, "Practical Application of Thermodynamics to Plutonium Process Reactions at High Temperature," *Symposium on Thermodynamics with Emphasis on Nuclear Materials and Atomic Transport in Solids*, International Atomic Energy Agency, Vienna, 1966, Vol. 1, p. 462.
8. R. A. Penneman and L. B. Asprey, "Review of Americium and Curium Chemistry," Paper P/833, *Proc. Intern. Conf. Peaceful Uses of Atomic Energy*, Geneva, 1955, 7, 355 (1956).
9. N. Edelstein, W. Easley and R. McLaughlin, "Formation and Characterization of Divalent Americium in CaF₂ Crystals," *J. Chem. Phys.*, 44, 3130 (1966).

APPENDIX

Plots of $K'/K'_{\max.}$ as a function of wt. % Pu in the salt phase for the 730°C. distribution experiments are given in Figs. 2 through 7. $K'/K'_{\max.}$ is plotted on the x axis and wt. % Pu in the salt is plotted on the y axis.

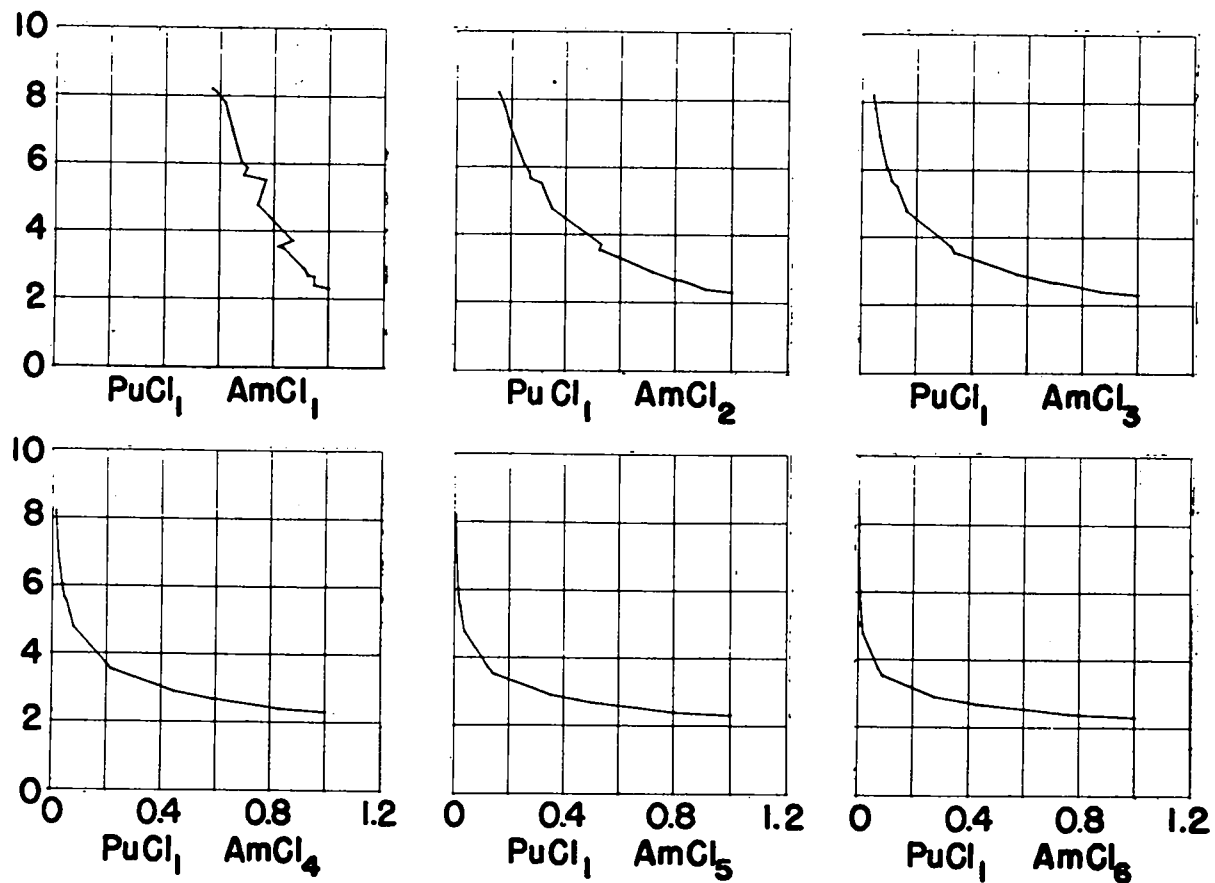

Fig. 2. K'/K'_{\max} (x axis) vs. wt. % Pu in Salt (y axis), 730°C ., for the Stoichiometry PuCl_1 and AmCl_1 through AmCl_6

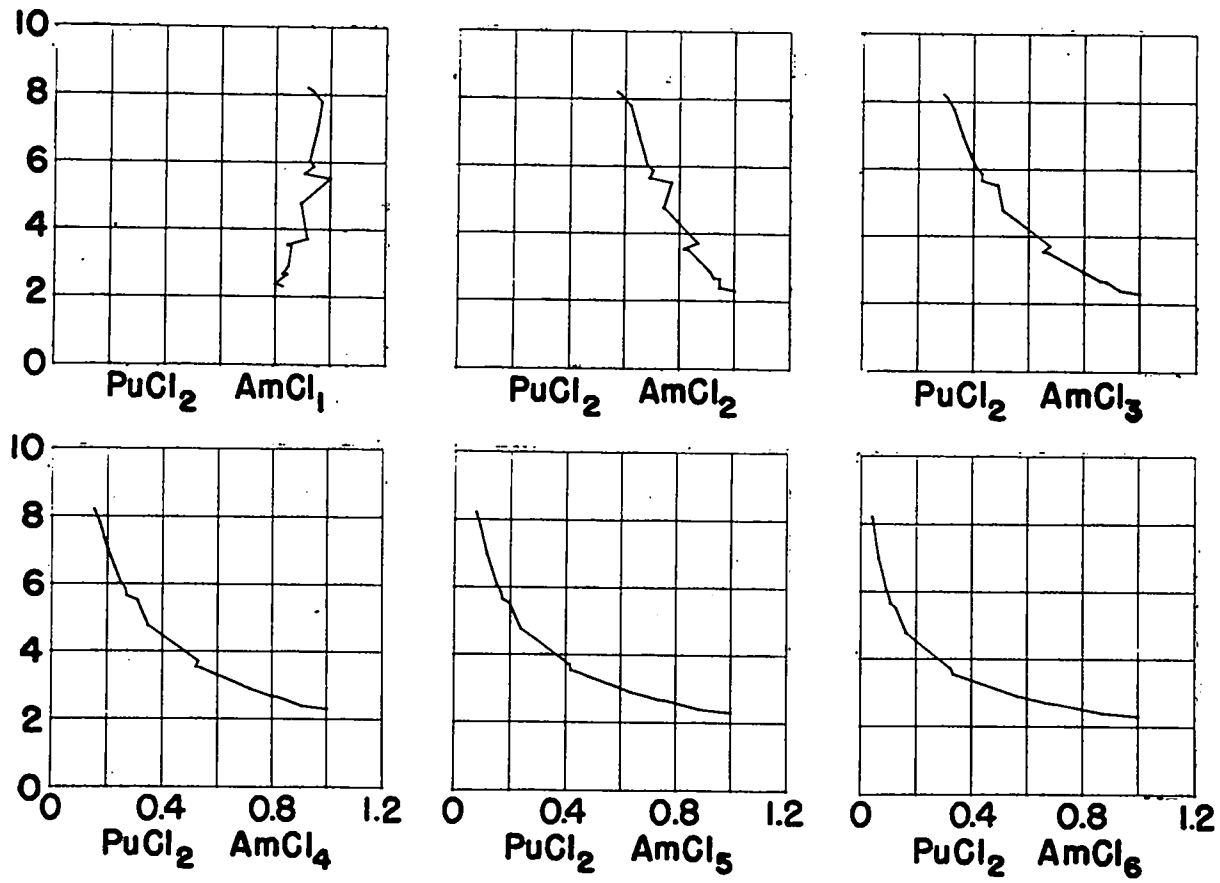

Fig. 3. K'/K'_{max} (x axis) vs. wt. % Pu in Salt (y axis), 730°C., for the Stoichiometry PuCl₂ and AmCl₁ through AmCl₆

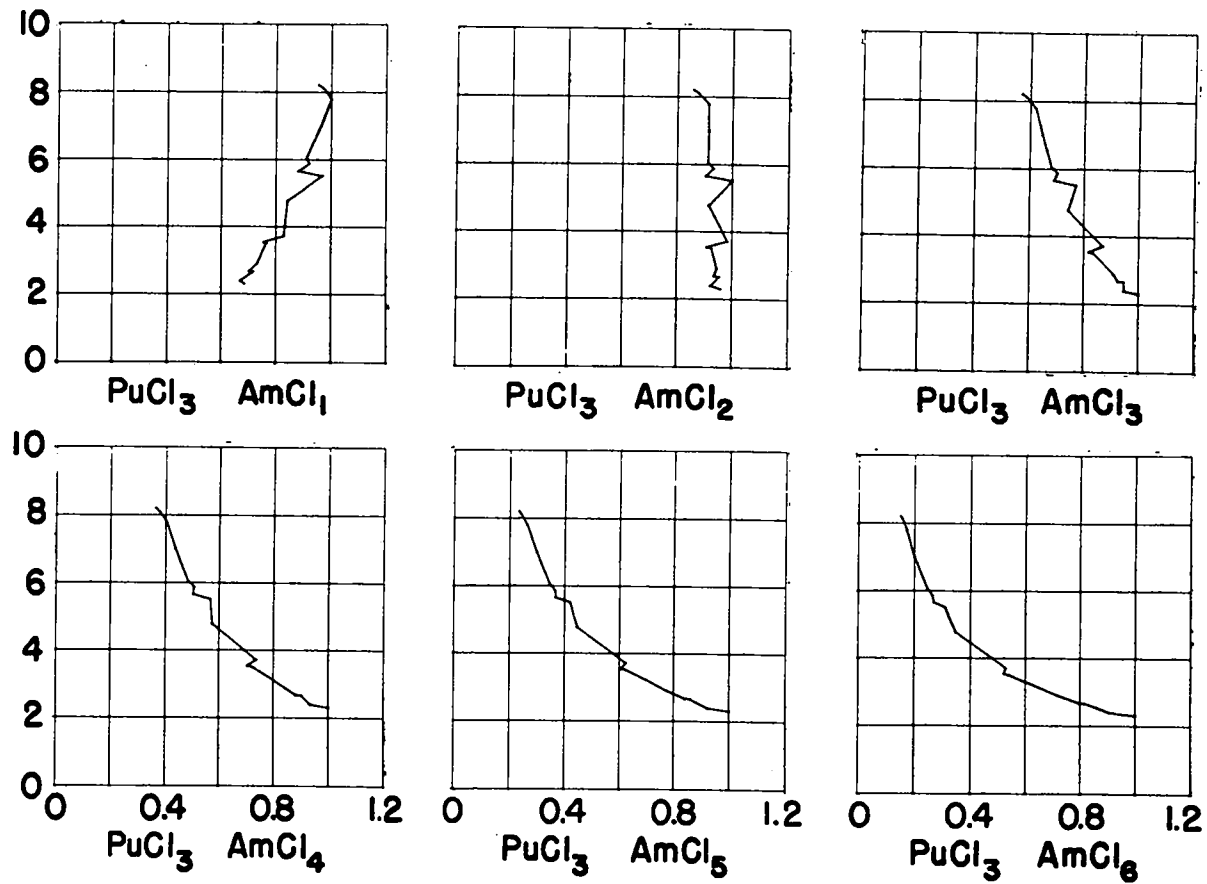

Fig. 4. K'/K'_{\max} (x axis) vs. wt. % Pu in Salt (y axis), 730°C ., for the Stoichiometry PuCl_3 and AmCl_1 through AmCl_6

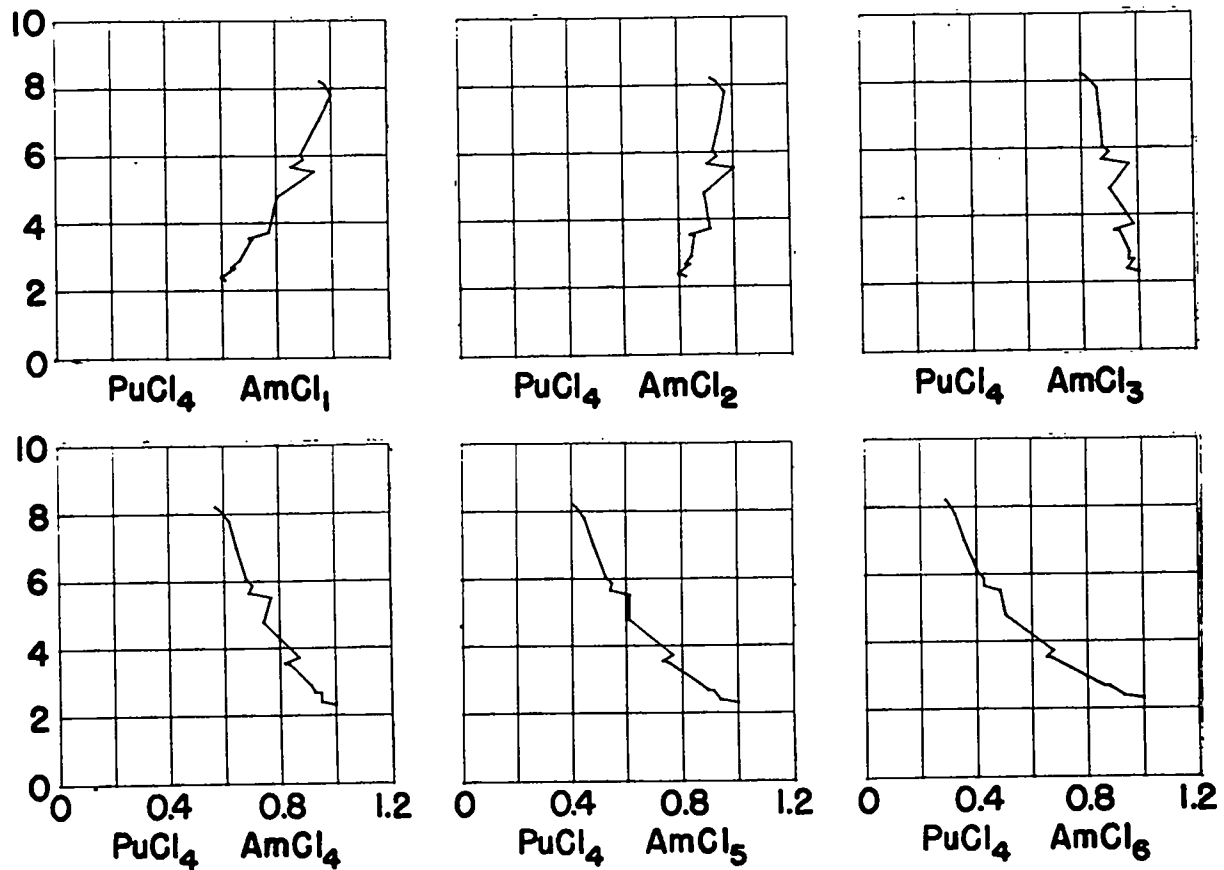

Fig. 5. K'/K'_{max} (x axis) vs. wt. % Pu in Salt (y axis), $730^{\circ}C.$, for the Stoichiometry $PuCl_4$ and $AmCl_1$ through $AmCl_6$

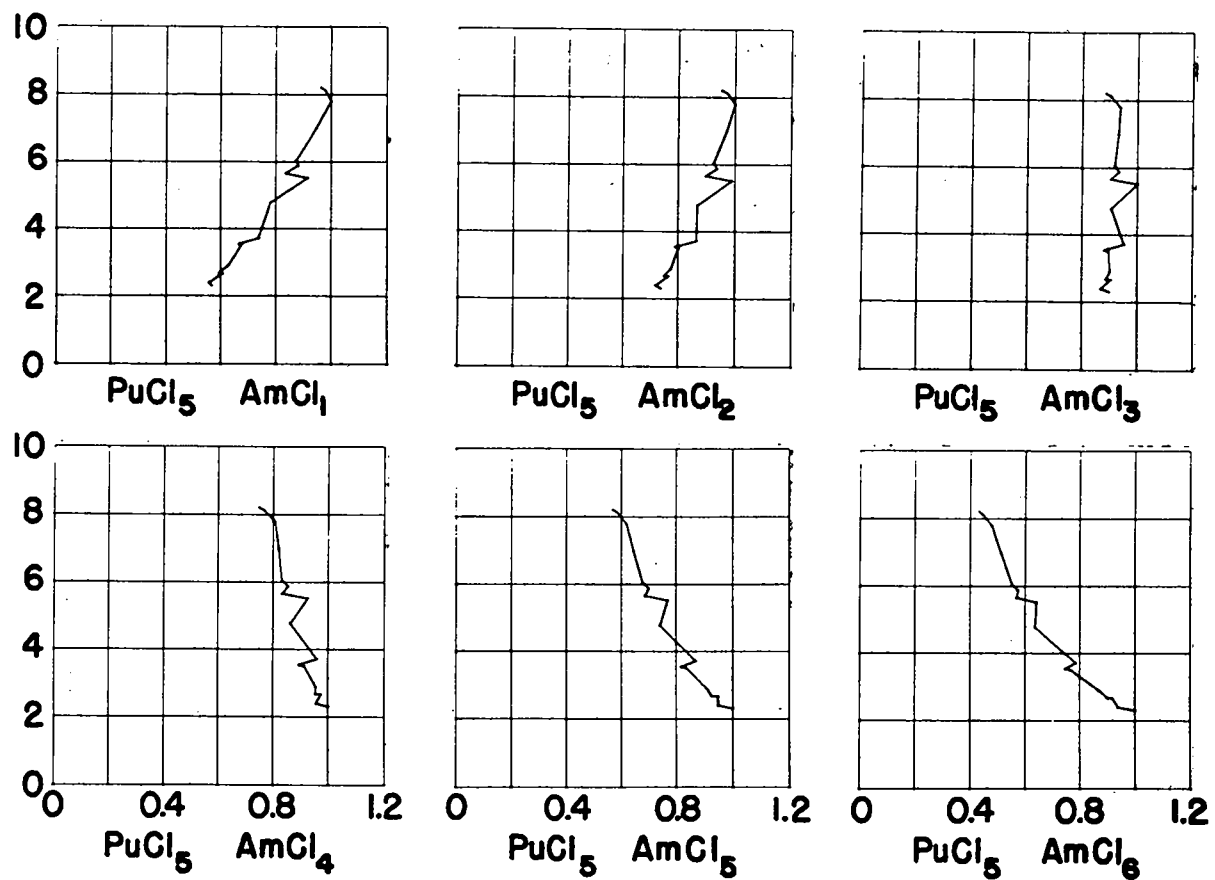

Fig. 6. K'/K'_{max} (x axis) vs. wt. % Pu in Salt (y axis), 730°C ., for the Stoichiometry PuCl_5 and AmCl_1 through AmCl_6

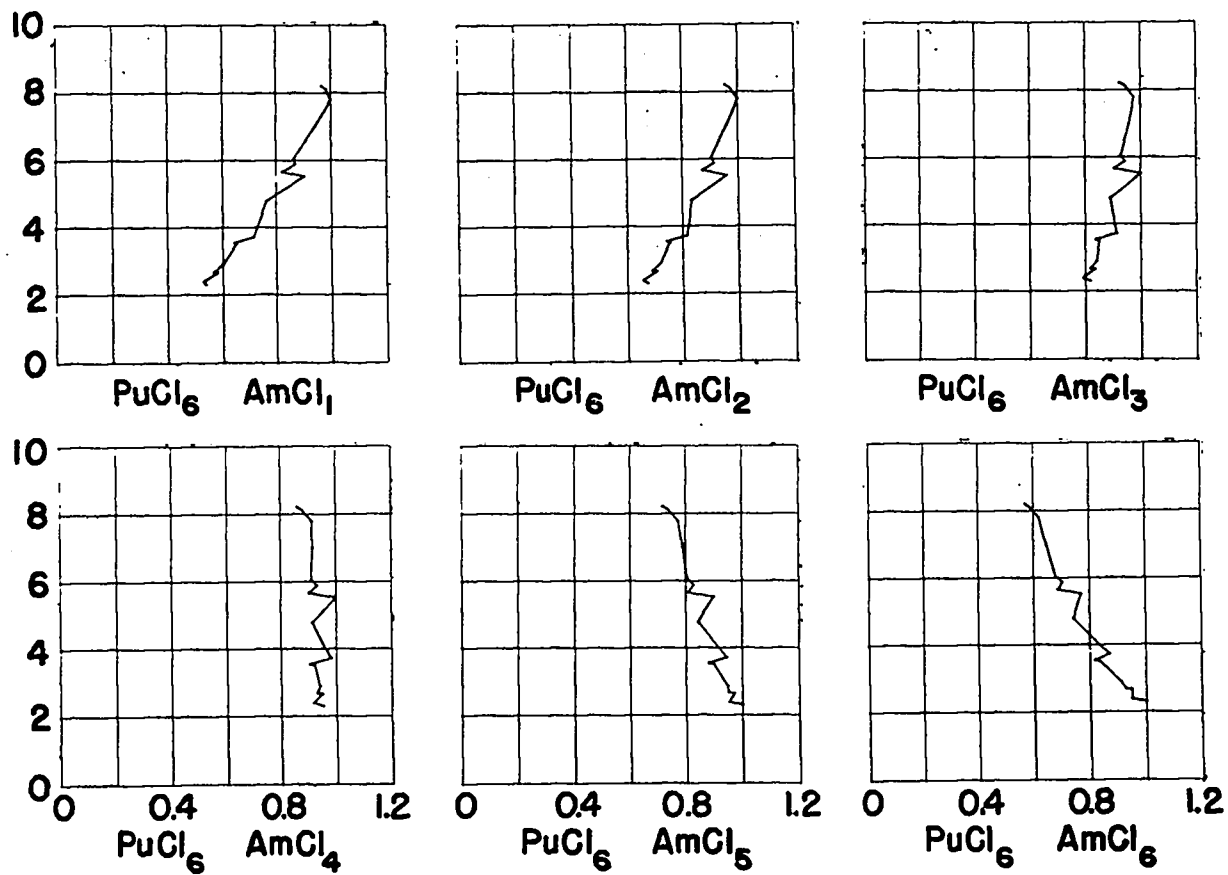

Fig. 7. K'/K'_{max} (x axis) vs. wt. % Pu in Salt (y axis), $730^{\circ}C.$, for the Stoichiometry $PuCl_6$ and $AmCl_1$ through $AmCl_6$