

*Cover Photo: Chemistry and Metallurgy Research Building*

*An Affirmative Action/Equal Opportunity Employer*

*This report was prepared as an account of work sponsored by an agency of the United States Government. Neither the United States Government nor any agency thereof, nor any of their employees, makes any warranty, express or implied, or assumes any legal liability or responsibility for the accuracy, completeness, or usefulness of any information, apparatus, product, or process disclosed, or represents that its use would not infringe privately owned rights. Reference herein to any specific commercial product, process, or service by trade name, trademark, manufacturer, or otherwise, does not necessarily constitute or imply its endorsement, recommendation, or favoring by the United States Government or any agency thereof. The views and opinions of authors expressed herein do not necessarily state or reflect those of the United States Government or any agency thereof.*

*Ventilation System History  
of a Plutonium Analytical  
Chemistry Laboratory*

*Joel W. Dahlby  
William E. George  
Manuel Gonzales  
Ronald G. Stafford*





## CONTENTS

ABSTRACT	1
BUILDING DESCRIPTION	1
VENTILATION SYSTEM	1
CONTAINMENT BOXES	2
Glove Boxes	2
Open-Port Boxes	2
Open-Front Boxes	3
HOODS	3
MAINTENANCE EXPERIENCE	3
USER EXPERIENCE:	
THE ANALYTICAL CHEMISTRY GROUP	3
Safety Record	4
Flammable Organic Solvents	4
Generation of Acid Fumes	5
Sense of Awareness	5
Other Safety Concerns	5
Other Considerations	5
Conclusion	6
NEW INNOVATIONS	6
SUMMARY	7

# VENTILATION SYSTEM HISTORY OF A PLUTONIUM ANALYTICAL CHEMISTRY LABORATORY

by

Joel W. Dahlby, William E. George, Manuel Gonzales,  
and Ronald G. Stafford

## ABSTRACT

**The Chemistry and Metallurgy Research Building at Los Alamos has been used for nuclear materials research and development for the past 35 years. In this report, we describe the operation of the building with emphasis on its unique air ventilation system and on the experience gained by the Analytical Chemistry Group, one of the building occupants, over this period.**

---

## BUILDING DESCRIPTION

The Chemistry and Metallurgy Research (CMR) Building (Fig. 1) was occupied in 1952 and consisted of five wings plus an administration wing. In 1959, a wing was added to contain the hot cells used for the examination of spent reactor fuels. The building has three floors, including a full basement, and is 550,000 sq ft overall. A floor plan of one wing is shown in Fig. 2. The main laboratory areas and offices are on the first floor. The attic contains the air supply system and all the general utility supply, and the basement contains the exhaust ducts, drain lines, and a variety of support equipment. Recently, some laboratories have been added in the basement. Towers at the end of each wing contain the exhaust fans and filters.

## VENTILATION SYSTEM

The CMR Building has an extensive ventilation system that moves about 100,000 CFM of air through each wing. The air supply is pulled in through openings in the walls of each wing near the building's central spinal hall. The air then passes through a centrifugal fan turned by a 50-hp motor (Fig. 4) and is

dispersed to the rooms in the wing through a common duct (Fig. 5). Final heaters, thermostatically controlled, are located in the individual room ducts, and the air is dumped into the space above the false ceiling of each laboratory. The air then disperses through the many small holes (Fig. 6) in the false ceiling tile (529 holes/sq ft with each hole being 1/8 in. in diameter), resulting in a very smooth-flowing air supply for the hoods and open-front boxes. Each wing has four air supply systems: two large systems for offices and laboratories in each wing and two smaller units for the administration offices, change rooms, wing corridors, attic areas, basement areas, and spinal hall of the building. This spinal hall, which provides entrances to all wings, is the most overall positive pressure zone in the building, and air flows from this central spinal hall into the wings and into the laboratories.

After passing through the false ceiling, the air flow inside the wings takes the following path: Air that flows into the offices and personnel corridor is at the lowest negative pressure and therefore flows through the doors into the laboratories, as well as out through exhaust vents in the offices. Air flowing into

the laboratories from the personnel corridor, from the wing utility corridor, and from the supply ducts in the false ceiling exhausts through the hoods, open-front boxes, glove boxes or floor vents. Most of the exhaust air passes through hoods and containment boxes, follows exhaust ducts connected to each 3-ft section of the boxes (Fig. 7), then goes through the floor and into the main exhaust duct in the basement (Fig. 8).

All exhaust air from the laboratories goes into a main duct in the basement. This duct runs the length of the wing and increases in size from a beginning diameter of 2 ft up to a 5 ft diameter as it approaches the exhaust fan. This duct manifold has a water spray-down system that is activated daily for about 5 min to remove deposits of acids and dust. A drain from the duct goes into the contaminated acid drain line.

In addition to this sprayer-washdown system, where known acid-fuming operations are occurring, the exhaust air goes through scrubbers (Fig. 9) that wash acid fumes, etc., from the exhaust air with repetitive sprays of recirculated water. Preventing the scrubbers from drying up is accomplished by running makeup water into the recirculating water system at 10 to 15 gal./hour to prevent scaling and salt deposits. After the air goes through the scrubber, it then goes into the main exhaust duct (Fig. 10).

Two large centrifugal exhaust fans, turned by 1200-rpm, 150-hp or 1800 rpm, 200-hp motors (Fig. 11), are located at the end of each wing (one on the main floor and one on the second floor) just beyond the filters contained in a metal housing (Fig. 12). These fans are operating continuously and are inoperable only during total power outages in the building. During a total power outage, all supply air is also shut down, and the flow becomes static as dampers close to prevent back-flow of air into the building through the exhaust system.

The two exhaust fans are independently operable and the exhaust systems from each half of the wing are cross-connected to provide safety measures that are adequate to maintain air flow when one of the fans needs repair or replacement. Only in the hoods where air flow drops below 100-125 LFM does the

laboratory work involving nuclear materials shut down until repair is complete.

## CONTAINMENT BOXES

Containment enclosures or boxes for radioactive material are of three general types: glove boxes, open-port boxes, and open-front boxes (Fig. 13).

### Glove Boxes

A glove box (Fig. 14) provides a complete physical barrier. It is connected to a ventilation system and has glove ports and gloves to allow process and maintenance operations. Glove boxes are used for work with oxides or other forms of nuclear samples where a chance of airborne particulate contamination exists. These boxes have an air flow of ~20-50 ft<sup>3</sup>/min. The air enters the box through one or two parallel HEPA filters, sweeps through the box, and exhausts from the back of the box. These boxes usually have one pair of gloves per box, and boxes may be used individually or in a series of up to seven boxes. Chemical analysts who do work in these boxes wear laboratory smocks and surgeon's gloves for protection. The surgeon's gloves are worn to prevent contamination in the event of a leak in the glove-box gloves and also to make it easier to keep sweat from accumulating on the glove-box gloves. Connecting a series of glove boxes through a hinged door opening to an open-front box is good practice because it provides easy, quick, and safe access to the glove box or series of glove boxes. For small quantities of plutonium materials, this form of ingress or egress has proved superior in our operations to bag-in or bag-out procedures. All equipment and trash is removed by this means in most cases. For large pieces of equipment, the window can be removed, using special precautions, to allow easy access.

### Open-Port Boxes

Open-port boxes (Fig. 15) are sometimes (infrequently) used for special operations where the air-flow capacity is not adequate to support an open-front box. The air flow through the glove port openings is 100-125 LFM and allows safe handling of radioactive solutions. Analysts wear laboratory smocks and

surgeon's gloves as protective clothing when doing work in these boxes. The disadvantage of this type of box is that, when operations are performed requiring work in more than one box or requiring lateral movement, the worker must pull his hands out of the ports and insert them into the ports of the next box. This movement from one box to the other has the potential of spreading contamination outside the box unless strict preventative measures are taken. If an operation can be done in a single box, potential spread of contamination is considerably reduced because the worker takes off his surgeon's gloves before removing his hands from the ports.

### **Open-Front Boxes**

An open-front box (Fig. 16) is similar to a glove box except that it has an open slot along the front of the box in place of glove ports. Open-front boxes are used to contain solutions and other stabilized forms of radioactive materials. The air flow through the linear slot (~7 in. high and 30-36 in. long) is 100-125 LFM. Protective clothing worn while working in these boxes is laboratory smocks and surgeon's gloves. The operations performed in these open-front boxes are similar to those requiring versatile and sensitive manipulations normally done on a regular laboratory bench.

In normal operation, up to seven boxes of various combinations of open-front and glove boxes are connected in series (Fig. 17). The actual configuration is based on the chemical operations done in the boxes.

### **HOODS**

Regular laboratory fume hoods are used for operations with hazardous chemicals or for jobs that need to be contained for protection of the workers (Fig. 18). These fume hoods are limited to operations with nonradioactive materials.

Radiochemistry hoods are used for work with low-level radioactive solution samples that are prepared for radioactive counting techniques (Fig. 19).

### **MAINTENANCE EXPERIENCE**

Maintenance of the ventilation system has primarily been limited to replacement of motors, filters, and short sections of exhaust

duct. Each of these jobs requires that one exhaust fan be shut down but the other remains in operation, which makes the wing usable provided measures are taken to assure adequate air flow through the boxes.

Filters are replaced on an as-needed basis with the main criteria being pressure drops across the filter, usually caused by dust loading. The replacement frequency for these filters has generally been on a 3- to 5-year cycle. The air flow beyond the filters is sampled and checked for radioactive particulate matter.

The building is configured so that each wing can be operated independently with its own utility supplies and independent exhaust systems. Thus, a shutdown in one wing does not normally affect operations in other wings.

After exposure to chemicals for several years, replacement of some ductwork has been necessary. The original ductwork is made from stainless steel with no interior protective coating applied to protect it from corrosive acid fumes. However, only the ductwork connected to the boxes has been replaced. No replacement was necessary in the basement, but the areas where corrosion was worst have been patched. The washdown system that cleans corrosive chemicals and reactive materials from the duct interior surface on a daily basis has undoubtedly contributed to this long life.

Skilled engineers and craftsmen provide upkeep for the facility, and users of the building are not involved in these operations except in an advisory capacity. Health physics personnel work with the craftsmen when any potentially contaminated equipment is repaired.

Few modifications to the ventilation system have been necessary, and those were minor. Most of these changes have been due to changing the number of glove boxes and open-front boxes in individual laboratories. By rebalancing the air supply and exhaust system, these changes have been accommodated easily.

### **USER EXPERIENCE: THE ANALYTICAL CHEMISTRY GROUP**

For more than 35 years, CLS-1, a large analytical chemistry group with about 100 people, has handled nuclear materials safely in glove boxes and open-front boxes in the CMR Building. By comparing operations in these two

box systems from a safety standpoint, we have found that, under the appropriate conditions, open-front boxes can be operated safely, and in some situations, e.g., when working with volatile solvents, they are even more suitable than glove boxes because of the quick dilution and removal of the solvent fumes.

The combination of glove boxes and open-front boxes in CLS-1 has provided safe and effective use over the years. Currently CLS-1 has 170 glove boxes and 122 open-front boxes in use, which does not include the hoods and radiochemistry hoods. These boxes are generally connected in modules of up to seven individual boxes in a row (Fig. 17). As a general rule, all glove boxes that we install have an open-front box on the end for introducing and removing materials and equipment.

Many people assume that glove boxes are safer merely because they are closed systems. It is true that glove boxes are required for some operations with nuclear materials. For instance, work with oxide powders, salts, or other easily airborne materials always takes place in closed glove boxes. However, where almost no potential for airborne contamination exists, as with the relatively small quantities of plutonium material analytical chemists work with in solution or a freshly polished piece of metal, open-front boxes are appropriate and safe. Of course, as in any analytical chemistry operation, care must be taken to assure the work area inside and outside the box is kept meticulously clean to prevent any undue hazard.

#### **Safety Record**

In our 35 years (almost 6 million man hours) of operations with special nuclear materials in glove boxes and open-front boxes, no significant personnel exposure caused by failures in the ventilation system has occurred. During this time, we have had a large personnel turnover, and we have handled gram quantities of special nuclear materials. We estimate the total amount of nuclear material handled in our containment boxes by the Group over the years to be greater than 500,000 g. During these many years of operation, our safety record has remained superlative.

On numerous occasions, the exhaust air in our building has been interrupted accidentally in the midst of full operation. Electric power has been lost because of failure of the main power supply, once for as long as 12 hours. Many times individual wings of the building have lost power while work activities were in full operation, resulting in immediate evacuation of all personnel. After the power was restored, all laboratory floors and other surfaces were carefully checked for contamination by Health Protection Technicians. Even though almost half the containment boxes are open front, no contamination was detected outside the boxes; in addition, extremely sensitive continuous air monitors did not detect any airborne contamination when power was resumed other than the naturally occurring radon-thoron. Our documented evidence supports the fact that open-front boxes are safe and possibly safer than glove boxes for some of the procedures unique to the Analytical Chemistry Group.

#### **Flammable Organic Solvents**

Many of our analytical separations require specific solvents for specific procedures. Because some of these solvents are volatile and flammable, they cannot be used in our closed glove boxes. However, these explosive solvents can be used very safely in open-front boxes in small, well-controlled quantities because the open-front boxes are appropriately ventilated. Nonflammable reagents as substitutes many times are not available or are not as effective in delivering the highly precise results required by safeguard and security standards.

At least two chemical fires have occurred in open-front boxes, and they were easily extinguished by the chemist. If these fires had occurred in glove boxes and if fire-retardant material were not available in the glove boxes, they could have been out of control before extinguishing materials could be placed into the boxes, with the potential for radiation spread and personal injury. On another occasion, a solvent explosion in a glove box did cause serious damage and spread of radioactive material. Other DOE laboratories have experienced explosions in glove boxes. Explosions in open-front boxes are very rare because of the



increased air flow, which is considerably more than in closed systems. This air flow dilutes and removes solvent fumes before they become concentrated and produce an explosive hazard.

### **Generation of Acid Fumes**

Many of our analytical procedures require fuming with acids to remove detrimental materials before analysis. Acids used may include concentrated hydrochloric, nitric, sulfuric, perchloric, and acetic acids. Most of these acids may corrode the glove boxes and cause holes that will leak radioactive material into the laboratory. This corrosive action is greatly reduced in open-front boxes because of their greater air flow. A more serious matter, however, is the necessity for using perchloric acid in chemical procedures. In such procedures, the fumes must be quickly removed into a scrubber system to avoid any deposits of perchloric acid that could possibly cause a fire or an explosion. The most effective way to safely control these fumes is fast extraction of fumes from the containment box and rapid transfer into a scrubber. This extraction can be done most efficiently with downward-exhaust ducts, which can be washed daily with a water spray. The slower air flow through closed glove boxes makes it more difficult to remove the fumes fast enough and thus can allow the buildup of explosive mixtures. We have found that perchloric acid can be fumed safely in open-front boxes with the normal level of air flow and appropriate scrubbing.

### **Sense of Awareness**

Glove boxes can give workers a false sense of security; they may assume that the closed system protects them from all mistakes and inattention to details. For example, a pin hole is especially hazardous because it is not observable by the worker. "Pumping" of the glove by the worker while doing normal glove-box operations can spread contamination rapidly. However, complacency is not as much of a problem for analysts experienced with open-front boxes. Often, workers whose experience is with only closed glove boxes must be retrained to work more efficiently and safely in open-front boxes. An awareness of safety factors and of the hazardous nature of plutonium is crucial to maintaining an orderly and predictable

chemical environment. Open-front boxes contribute to this awareness by requiring constant attention and diligence by workers. These attributes are stressed during the training of all personnel.

### **Other Safety Concerns**

The use of open-front boxes is favored because they allow better visibility of the work area, permit better feel and control of operations performed, and allow the added dimension of being able to hear what is happening as the work progresses. Also, open-front boxes lead to safer operations by reducing operator fatigue, annoyance, stress, and frustration when performing the delicate operations necessary to obtain precise analytical chemistry results.

### **Other Considerations**

The increased air flow in hoods and open-front boxes when compared with that in glove boxes may cause an increase in heating or cooling costs. This increased air-flow capacity is necessary in a research and development chemistry laboratory because operations are continually changing and because the assurance that no flammable or hazardous vapors build up in dangerous amounts is required. Also, acid fumes must be quickly removed from the containment boxes and trapped in a scrubber system.

The increased air flow in these open-front boxes may also contribute greater oxygen quantities to a fire situation. However, keeping flammable materials to a minimum in any chemical laboratory is sound scientific practice. This is done by making the containment boxes and exhaust ducts from high-melting-point metals or alloys. Also, the prompt removal of flammable materials such as paper towels, rubber gloves, etc., is necessary to keep the fire potential to a minimum.

Open-front boxes and hoods are not recommended for process-type operations, where much larger quantities of nuclear materials are handled. Also, this type of box should not be used for volatile or powdered radioactive materials or where solutions are openly boiled.

Open-front containment boxes are intended only for the relatively small quantities of nuclear materials associated with analytical

chemistry activities. Also, analytical chemistry operations done in open-front boxes are specifically limited to work with solutions and freshly polished metals. Vigorous movements in these boxes or hoods must be avoided by both operating personnel and automated equipment so the normal air flow into the box is not disrupted.

Vigorous air turbulence in a laboratory where hoods or open-front boxes are used cannot be tolerated because it also disrupts the flow of air into the containment box. This turbulence is prevented by having a very dispersed supply of air into the laboratory, such as that designed into the CMR Building.

### Conclusions

We are aware of our responsibility to improve the containment systems whenever possible. The glove boxes and open-front boxes now in use in the analytical chemistry group are mostly of an old design (20 to 30 years old); boxes with better designs are available that permit more even air flow. The old boxes have one slot in the rear surface for air exhaust, and the newer ones have three evenly spaced slots in the rear vertical surface, which allows more even air flow in and through the box (Fig. 20). Figure 21 shows the air flow just outside an open-front box.

Because we work with a large variety of materials and perform many diverse operations, we rely on both closed glove boxes and open-front boxes to provide maximum safety for our personnel. Contamination problems in the operating group, whether with closed glove boxes or with open-front boxes, have been rare and usually could be cleaned easily with minimal disruption. Workers handling nuclear materials must be acutely aware of the necessity for neat, clean, and well-controlled working conditions, and they must not develop a complacent attitude about the safe handling of nuclear materials.

### NEW INNOVATIONS

New and innovative design ideas being tested in the DOE nuclear laboratory complex include use of devices to permit smoother air flow through open-front boxes.

Test sections of air foils have been used on open-front box openings to make the air flow into the box smoother, resulting in considerably less air turbulence inside the box.

The air flow volume through these boxes when they are not being used, such as overnight, could be lowered by providing a perforated barrier (Fig. 22) that would be placed over the opening to reduce the air flow volume by >75%. Tests of the plastic cover showed that no contamination was detected on its inside surface after months of continuous use.

Generally having a hood or open-front box adjacent to a door is considered poor practice. However in many laboratory configurations, this arrangement is necessary to use the laboratory space efficiently. The fear is that the disruption of smooth air flow when the door is opened will "draw" air out of the containment hood or box. In extreme cases, air flow has been disrupted, possibly when most of the supply air could come in through an open door. However, Fig. 23 shows that, in one of our laboratories, some disruption to the smoothness of the air flow inside the box occurs when a door adjacent (within 1 foot) to the box opening is opened or closed. When a door is opened, the air flow is disrupted slightly inside the box, but during this test, no detectable air was pulled from the box. Comparison of air flows in Figs. 21 and 23 illustrates this.

Other innovations are air flow monitors connected to each box that regulate dampers. The question is how long a complicated system with many damper controls like this can work effectively when it handles corrosive materials. The British have designed a no-moving-part vortex damper that could be very effective in solving this mechanical damper problem.

Figure 24 shows a new containment box design that can be backed tightly against a wall. This design will save many square feet of laboratory floor space. We currently have some of these boxes on order for testing in plutonium-handling laboratories.

We are also testing special coatings on the inside surfaces of glove boxes. Some baked-on coatings have shown very good resistance to corrosive acid mixtures. The British are planning to use a ceramic coating on their steel boxes.

## SUMMARY

The design of the CMR Building ventilation system works well for our activities. Key to the successful operation may be the smooth and dispersed flow of inlet, or supply, air into the laboratories where hoods and open-front boxes are used. This forethought in design has permitted the building to be operated successfully,

safely, and effectively with minimal repair or maintenance for its 35-year life.

By studying this system, we can design an even better system that will incorporate new advances and will be even more effective in a new facility.



*Fig. 1. Chemistry and Metalurgy Research Building.*

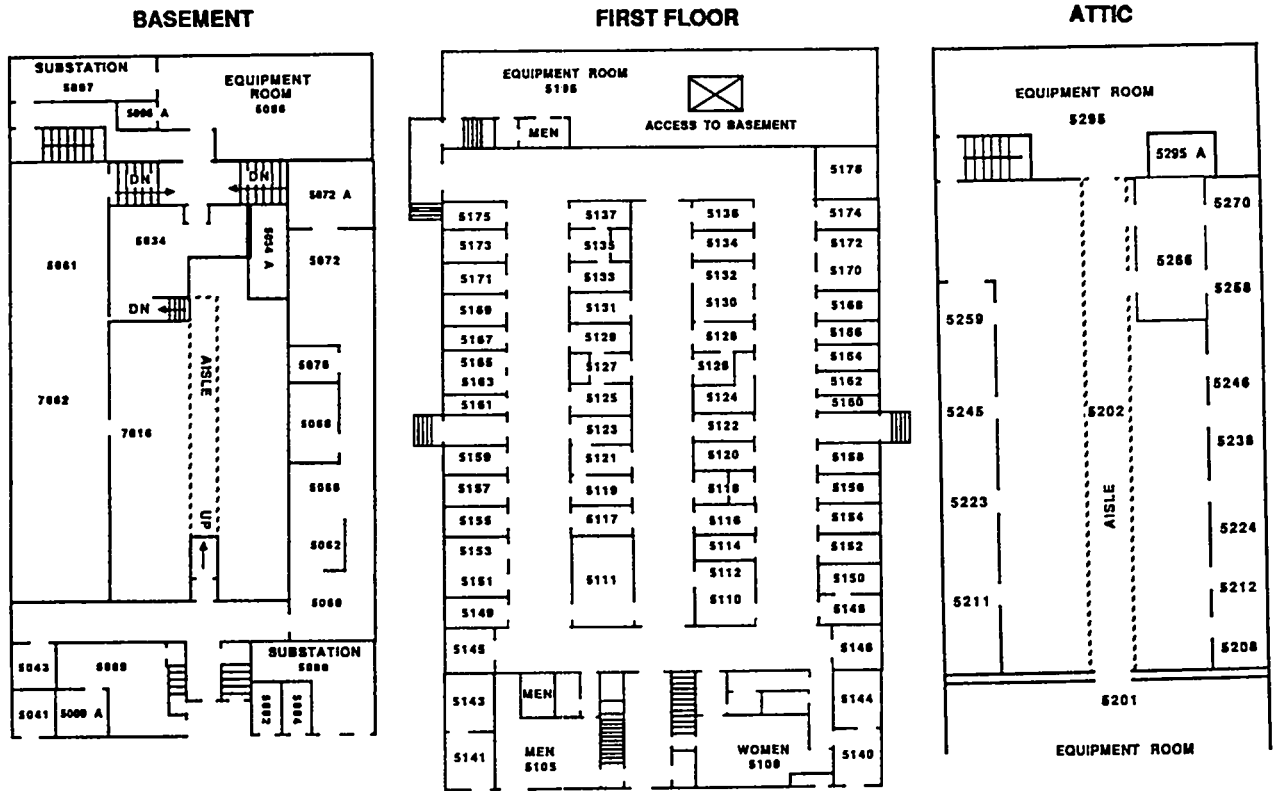


Fig. 2. Typical floor plans of the three floors.

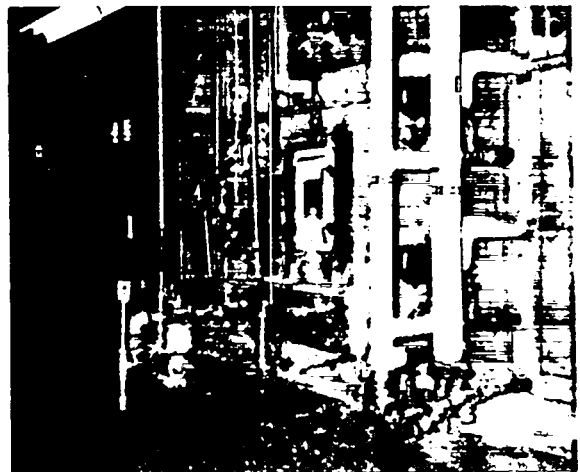
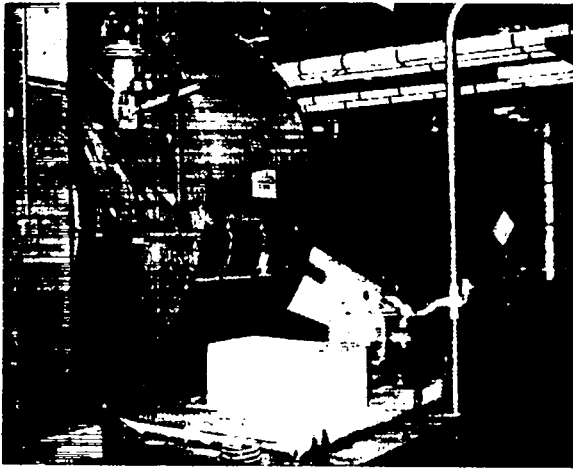


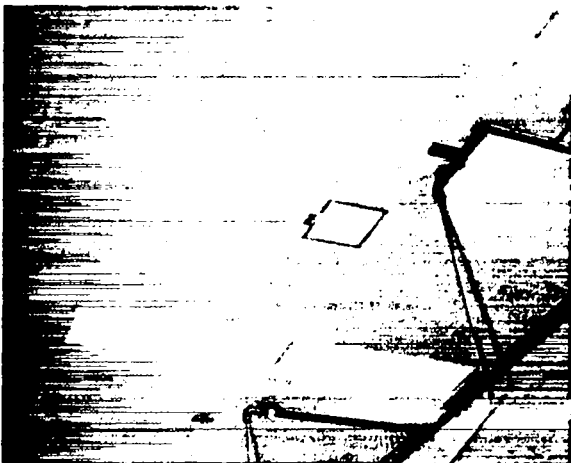
Fig. 3. Inlet air pretreatment compartment.



*Fig. 4. Supply air fan and motor.*

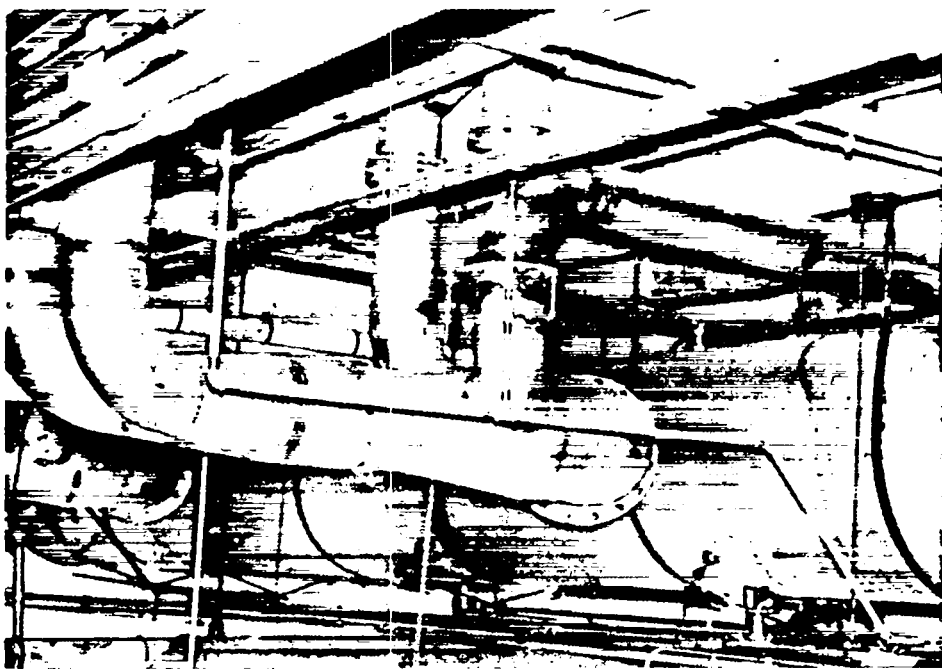
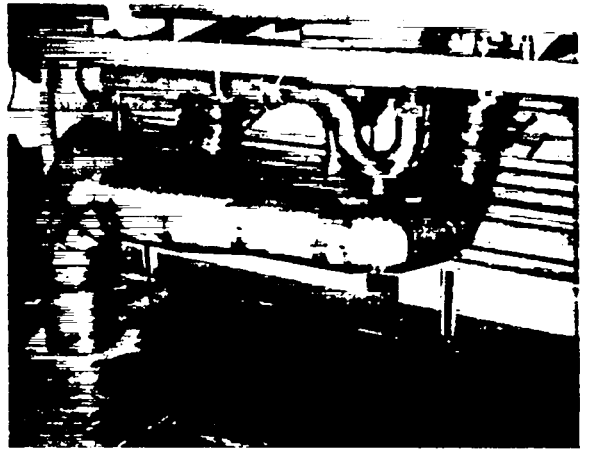


*Fig. 5. Supply air ductwork.*



*Fig. 6. Ceiling tile with air dispersion holes.*

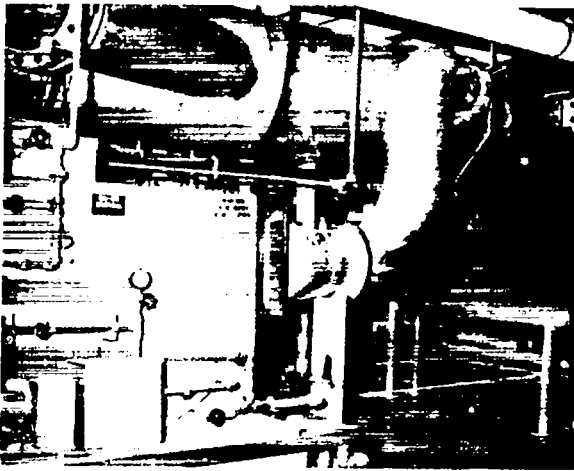
*Fig. 7. Containment box exhaust ductwork.*



*Fig. 8. Collection exhaust duct and main exhaust duct.*



*Fig. 9. Acid fume scrubber.*



*Fig. 10. Exhaust from acid fume scrubber and main duct.*



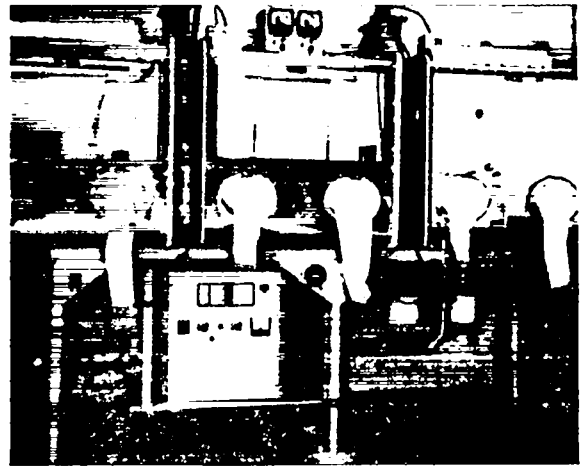
*Fig. 11. Exhaust fan and motor.*



*Fig. 12. HEPA filter housing.*

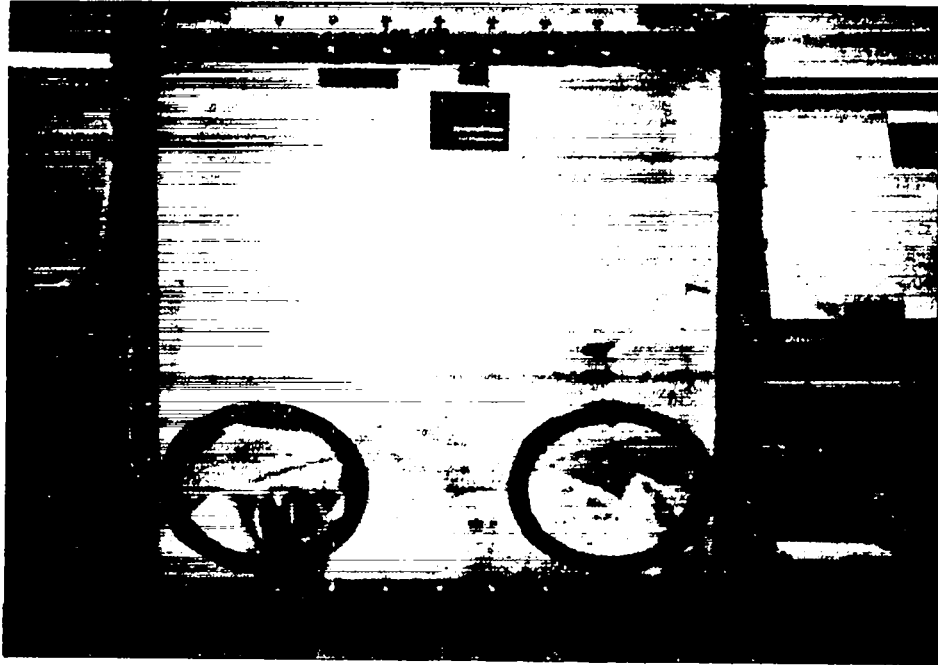


*Fig. 13. Array of glove box, open-port box, and open-front box.*



*Fig. 14. Glove boxes.*





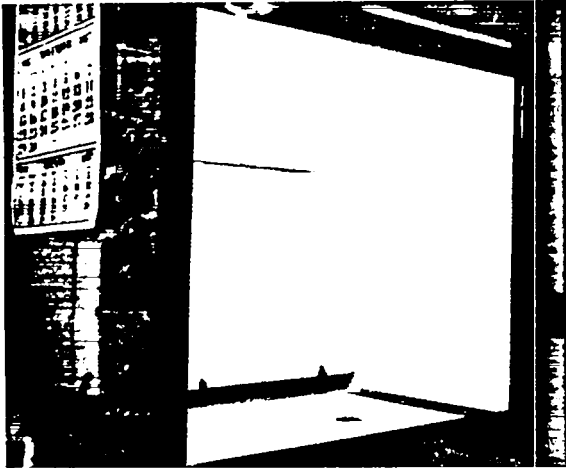
*Fig. 15. Open-port boxes.*



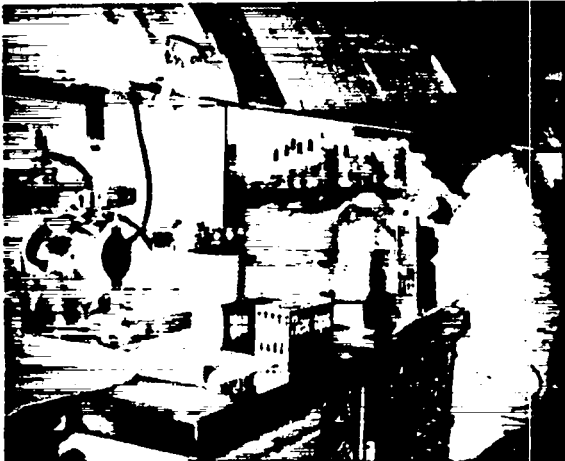
*Fig. 16. Open-front boxes.*



*Fig. 17. Set of open-front boxes and glove boxes.*



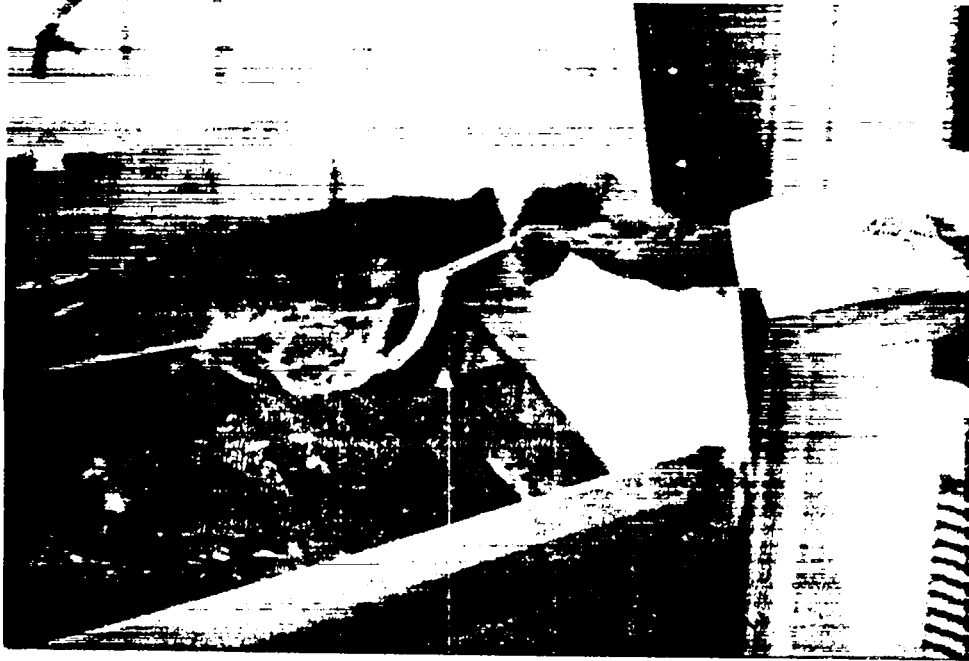
*Fig. 18. Laboratory hood.*



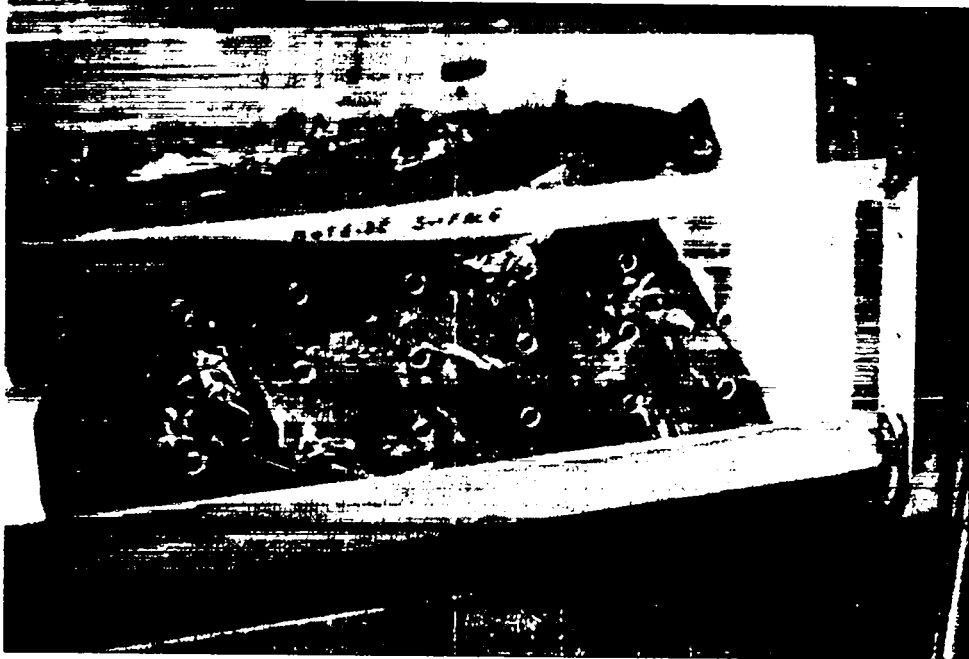
*Fig. 19. Radiochemistry hood.*



*Fig. 20. Three-slotted box exhaust.*



*Fig. 21. Air flow through open-front box opening.*



*Fig. 22. Perforated air flow barrier.*



Fig. 23. Air flow beside open laboratory door.

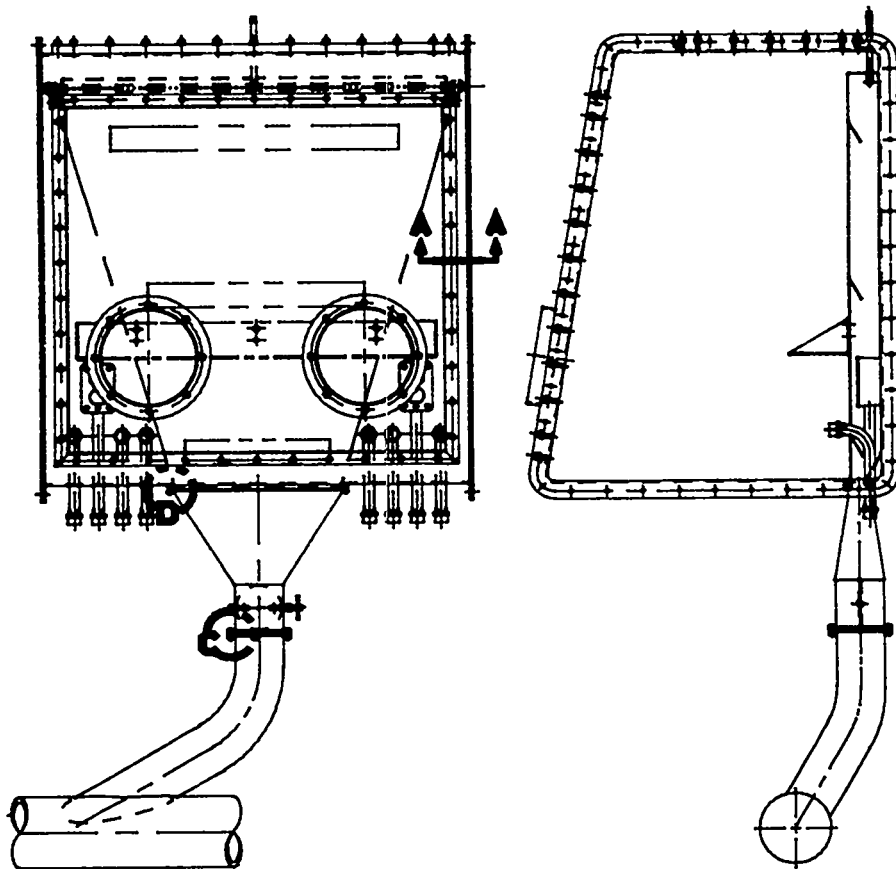


Fig. 24. New containment box design.

Printed in the United States of America  
Available from  
National Technical Information Service  
US Department of Commerce  
5285 Port Royal Road  
Springfield, VA 22161

Microfiche (A01)

Page Range	NTIS Price Code	Page Range	NTIS Price Code	Page Range	NTIS Price Code	Page Range	NTIS Price Code
001-025	A02	151-175	A08	301-325	A14	451-475	A20
026-050	A03	176-200	A09	326-350	A15	476-500	A21
051-075	A04	201-225	A10	351-375	A16	501-525	A22
076-100	A05	226-250	A11	376-400	A17	526-550	A23
101-125	A06	251-275	A12	401-425	A18	551-575	A24
126-150	A07	276-300	A13	426-450	A19	576-600	A25
						601-up*	A99

\*Contact NTIS for a price quote.

FIRST CLASS

United States Department of Energy  
Office of Scientific and Technical Information  
Post Office Box 62  
Oak Ridge, Tennessee 37831

OFFICIAL BUSINESS  
PENALTY FOR PRIVATE USE, \$300



13280 FS- 1 B  
LOS ALAMOS NATIONAL LAB  
ATTN J A FREED  
REPORT LIBRARIAN, MS P364  
PO BOX 1663  
LOS ALAMOS, NM 87545

VOID VOID VOID VOID  
VOID VOID VOID VOID  
VOID VOID VOID VOID  
VOID VOID VOID VOID  
VOID VOID VOID VOID  
VOID VOID VOID VOID

