

SCANNED NOV 13 1996  
UNCLASSIFIED

LAMS-439 C.3  
[REDACTED]  
UNCLASSIFIED  
[REDACTED]

LOS ALAMOS NATIONAL LABORATORY  
3 9338 00349 5230

UNCLASSIFIED  
SCANNED NOV 13 1996

UNCLASSIFIED

CIC-14 REPORT COLLECTION  
REPRODUCTION  
COPY

UNCLASSIFIED

UNCLASSIFIED LAMS- 439 C.3

PUBLICLY RELEASABLE  
LANL Classification Group

*Mark A. Lee*  
2/2/96

SERIES B

SPECIAL RE-REVIEW  
FINAL DETERMINATION  
UNCLASSIFIED, DATE: 4/7/81

TOP SECRET

Authority of the District Engineer

By *Delaney*  
Date MAR 24 1987

VERIFIED UNCLASSIFIED

Per *SLW 4-7-81*  
By *J. D. B. 2-8-96*

VERIFIED UNCLASSIFIED

*NDA 6/14/79*  
*SLW 4/7/81*

Classification changed to UNCLASSIFIED  
by authority of the U. S. Atomic Energy Commission

Per AEC/TID-1400-501 Sent - Oct 1974

By REPORT LIBRARY

*Madra Lander 6/27/75*  
UNCLASSIFIED

Classification changed  
by authority of *J. L. Lague*  
3-23-49 See Count 6 to Doc Rem  
3-22-49

*R.C. Smith etc. 4-30-51*

NOV 13 1987

SCANNED

LOS ALAMOS NATL. LAB. LIBS.  
3 9338 00349 5230

UNCLASSIFIED

UNCLASSIFIED

UNCLASSIFIED

UNCLASSIFIED

LAMS - 439

September 1, 1946

This document contains 30 pages.

RADIATION INTENSITY vs TIME

INSIDE TARGET SHIPS

Report Written by:

J. L. Tuck

UNCLASSIFIED

UNCLASSIFIED

UNCLASSIFIED

UNCLASSIFIED

Crossroads Technical Instrumentation Report

Tests A and B

1 September 1946

From: Los Alamos Field Group O13H  
To: Technical Director, JTF-1  
Project No.: V - II  
Subject: Radiation Intensity vs. Time Inside Target Ships

Prepared by: J.L. Tuck  
Approved: M.G. Holloway

*M.G. Holloway*

ABSTRACT

The intensity of gamma radiation in Tests Able and Baker was measured by an ionization chamber recording equipment over the period from one second to several hours after the explosion and at several points throughout the ship array.

In the air burst shot, the observed variation of gamma ray intensity is roughly compatible with a hypothesis that most of the fission products are in the ball of fire, emitting delayed gamma rays at the rate observed in the laboratory. Intensity after the first minute was small.

In the underwater shot, the burst of intensity the first minute was smaller, but followed by a sustained rise attributable to the return of fission products to the vicinity of the ships as rain.

Estimates of gamma dose were found to agree with independent estimates made by the radiological group from similarly located films.

Tactically, the dosage rates are such that in an ABIE type attack, exposed personnel could benefit by prompt dodging behind a shield while in a BAKER type attack, similar protective action could be taken.

UNCLASSIFIED

UNCLASSIFIED

UNCLASSIFIED

-2-

UNCLASSIFIED

INTRODUCTION

Our knowledge of the gamma ray phenomenon associated with atomic bombs showed some gaps and some contradictions when these Able and Baker shots were being planned. Of the published material, LA. 218 and LA. 250 (V. Weisskopf et al.) gave theoretical estimates of the dosage from various factors in the explosion, of which factors, the delayed gammas appeared to be by far the most important. Figures for the contribution of these was based on Fermi's measurements for delayed gamma intensity as a function of time and a reasonable estimate for the mean gamma ray energy of about 1.5 Mev., giving a mean free path in air of 220 meters. In LA. 432 (Segre, Deutsch, et al.) reported that the ionization intensity at Trinity saturated their ionization chamber recording equipment. Films were also exposed, but the high level of local ground contamination made estimates of proportion of the blackening due to the direct gamma radiation from the bomb uncertain. From Hiroshima and Nagasaki came reports of casualties from gamma radiation at distances of 1500, 2000 meters and beyond, which, if the usually accepted lethal dose of 300 to 500R was taken to apply, was strongly in conflict both with the predictions of LA. 218 and 250 and with a measurement obtained at Nagasaki from film fogged in a hospital by radiation at 1500 meters, indicating a dose of only 10R. It was decided, therefore, to supplement the usual gamma ray film measurements at the Crossroads operation with gamma ray time measurements. The purpose of these latter was to give information on such points as how the gamma ray dose was divided among the various factors of (1) direct radiation from the fission product cloud, (2) ship contamination, (3) water-borne contam-

UNCLASSIFIED

UNCLASSIFIED

UNCLASSIFIED

UNCLASSIFIED

UNCLASSIFIED

ination, (4) wind-borne contamination and also on the possibility of taking evasive action from the radiation. Another point was that should the local contamination be strong, the time record might supply a key to the interpretation of the film records.

### Experimental

#### 1. General

An experiment of this kind requiring measurement of a time varying quantity on a number of isolated and widely distributed ships seems to fall into two patterns involving either the large effort with gamma ray detection on the ships and radio transmission of data to a remote recording station achieving perhaps microsecond resolving power, or the smaller effort with rather simple completely self contained recording units, necessarily battery operated, of more modest performance.

Time for preparation was such that strict simplification of even the second procedure was necessary. Requirements were set at:-

- (1) No film recording, many records having been lost at Trinity through fogging.
- (2) Apparatus not primarily dependant on triggering by radio signal.
- (3) Capable of remaining in a receptive state for several days in order to be able to tolerate a postponement of firing day without reservicing.
- (4) Protection from blast, ship motion and tropical humidity.
- (5) Ability to record a wide range of gamma intensities.

The resulting apparatus illustrated in Fig. 2, is in essence an ionization chamber which actuates via an amplifier in a manner proportional to the logarithm of the gamma ray intensity, the pen of a recorder which

UNCLASSIFIED

UNCLASSIFIED

UNCLASSIFIED

-4-

UNCLASSIFIED

writes in ink on a chart driven by clockwork.

The chart is advanced at the slow rate of 1/10" per minute, with enough chart to run for 7 days. In its final form, a radio triggering equipment, introduced as 60 fold improvement in resolving powers without sacrificing reliability, by actuating a change speed mechanism increasing the chart speed to 6" per minute, and giving a total running time of 3 or 4 hours.

The equipment was enclosed in an airtight Dural drum, and mountable by a single point suspension.

## 2. The Chamber

This was of a type formerly used in RaLa work designed for electron collection. We are indebted to Dr. D. Hall of M-2 for the supply of these. They had a 3" diameter 12" long brass tubular envelope and a 15 mil central wire electrode passing through hermetic seals with guard rings. The chambers were filled to a total pressure of 3 atmospheres with argon + 2% CO<sub>2</sub>. These chambers were found to be very reliable and similar in their properties, doubtless on account of the long experience and production methods used in their manufacture. High tension supply at 2000 V was supplied from a specially made compact dry battery (W3). The electrical properties of the chambers are described more fully in Figs. 3, 4, and 5 and under "calibration".

## 3. The Amplifier

UNCLASSIFIED

From calculations of the gamma ray intensities expected, the minimum intensity to be recorded was set at 100,000 R/hr and the minimum estimated to be a safe background intensity for inspection and recovery, at 1R/hr, giving a ratio of 10<sup>5</sup>. This ratio is based on the known chamber sensitivity,

UNCLASSIFIED

UNCLASSIFIED

set the amplifier requirement as an input range from  $10^{-10}$  A to  $10^{-5}$  A with an output from 0 to 3 m.a. through a resistance of 1400 ohms.

We are indebted to Dr. R. Watts who was able to develop for this work, a battery operated DC amplifier having very satisfactory logarithmic properties. This amplifier consisted (Fig. 1) basically of a high insulation cathode follower (959) used in a well known circuit feeding into a two triode balanced bridge circuit which developed the required power output.

The input signal to the cathode follower consisted of the potential developed by the ionization current across the variable anode cathode resistance of a miniature triode, V32. This resistance was lowered as the input signal increased, by connecting the grid of the V32 to the output of the cathode follower. The effect of this direct current negative feedback was to give an amplifier sensitivity which decreased with increasing signal input in a manner dependent on the properties of the impedance tube its bias and the operating conditions of the 959 cathode follower. In our case, when the logarithm of the current input was plotted against the output deflection, a satisfactory S shaped curve was obtained covering an input range of 5 decades. At first the amplifier sensitivity was found to be too high for small signals and it was found possible to adjust the initial sensitivity to a convenient level by shunting the V32 impedance tube by a  $1.5 \times 10^8$  ohms resistance.

Since the amplifier output is in terms of the logarithm of a current the amplifier could not be tested by a voltage generator and a current signal generator was therefore designed, known as the imitation chamber, Fig. 1b, which proved to be a great convenience in testing. This consisted of a 250 V battery potentiometer and a set of high resistances graduated provided currents in roughly equal steps of log i from 1 to  $25000 \times 10^{-10}$  amperes.

UNCLASSIFIED



FIG 1 CIRCUIT DIAGRAM OF GAMMA RAY RECORDER UNIT

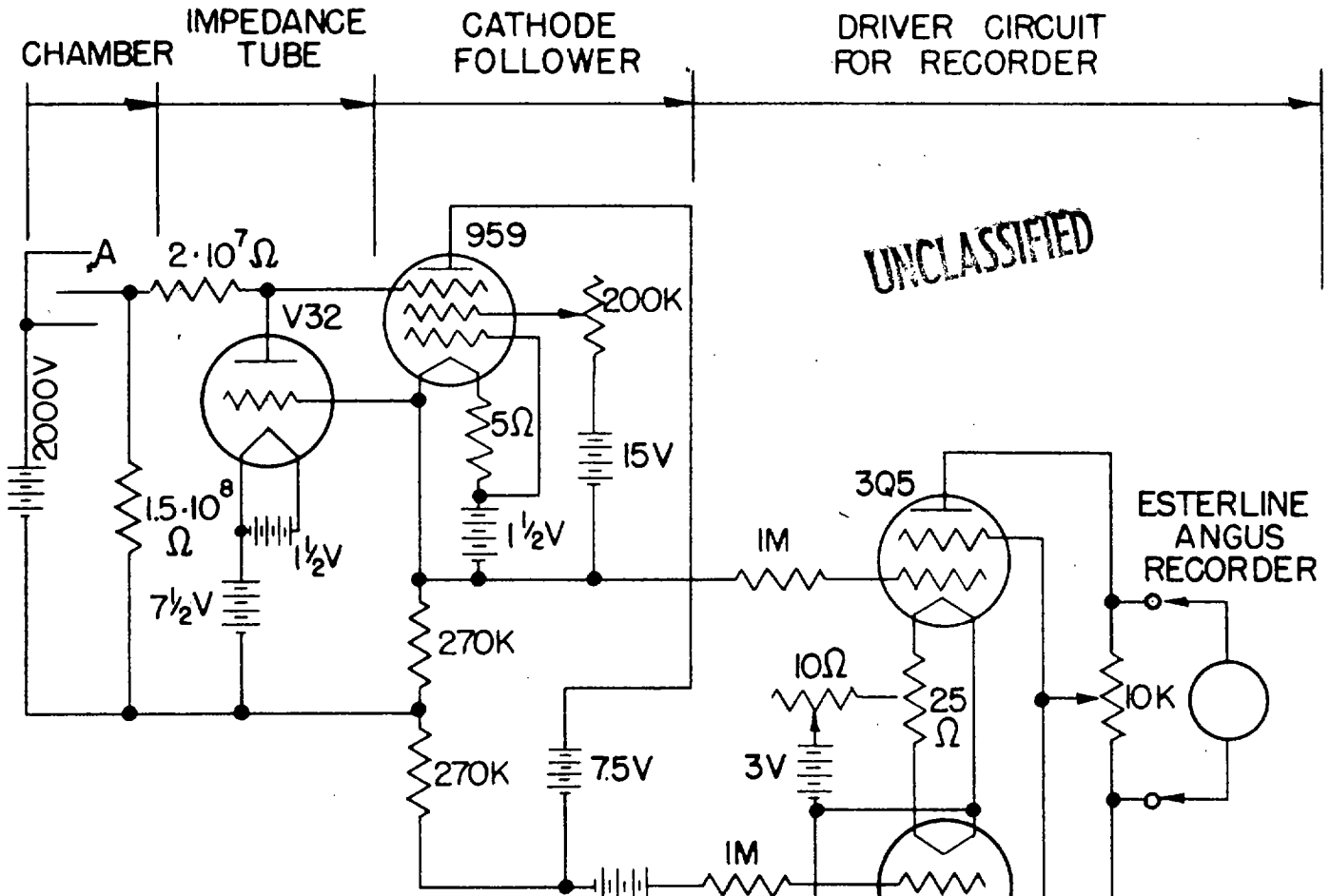

UNCLASSIFIED

FIG 2 TEST UNIT FOR ABOVE 3V

BY MEANS OF THE METER "M" AND POTENTIOMETER "A", A SERIES OF VOLTAGES FROM 1 VOLT TO 250 VOLTS CAN BE APPLIED TO THE HIGH RESISTOR BANK R WHICH HAS A RANGE OF VALUES  $2.5 \cdot 10^9 \rightarrow 10^7 \Omega$ .

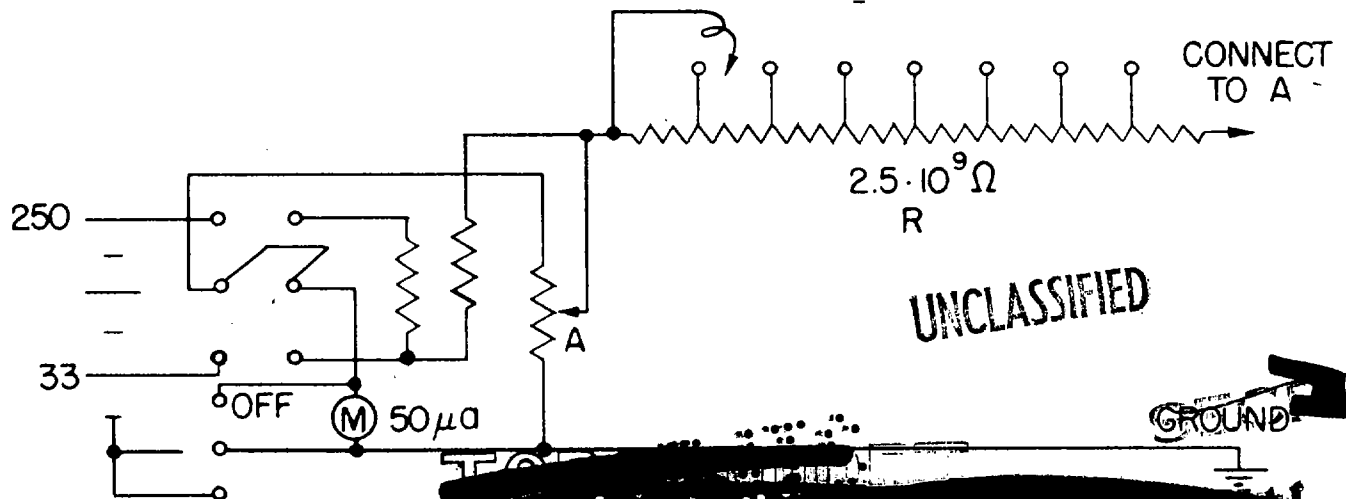

UNCLASSIFIED

  
4. Recorder

UNCLASSIFIED

It was important in selecting the recording instrument to take account of the effect of the under water shot transmitted through the ships structure and of the violent pitching expected due to wave and blast effects from the bomb. Of the many types of recording on paper instruments some used electro-chemical or hot wire stylus methods of recording and were free from ink spilling difficulties but were not procurable in time, while others used robust potentiometric balancing eg Micromax but required alternating current main power which was not expected to be available. The greater part of the available battery space for the recorder was found to be taken up by the recorder driver stage requirements, so that economy in the power used by the recorder movement was a consideration. A high sensitivity Esterline Angus movement requiring 1 m.a. full scale proved to be too sensitive to pitching and rolling of the kind expected on shipboard. At the suggestion of the makers, a restoring spring of increased stiffness was adopted in such a movement, which reduced the current sensitivity to 3 m.a. full scale and the period to 0.2 seconds. This modified movement was found by experiment to be very insensitive to the anticipated pitching and rolling, while the battery requirements remained within acceptable limits.

## 5. The can and mounting

It proved possible to accommodate the foregoing equipment inside a cylinder of 20" diameter and 39" length. The equipment was mounted on a rack bolted to a top plate, and a 1/8" thick dural can, fitted with clamps was arranged to enclose the equipment forming an airtight seal with a rubber gasket at the top by a contrivance (Fig. 2) similar to the lid of some types of pressure cooker.

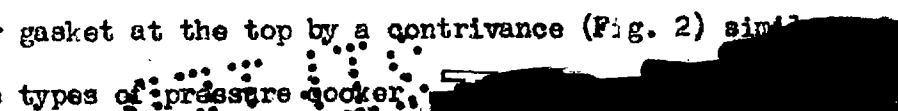

UNCLASSIFIED

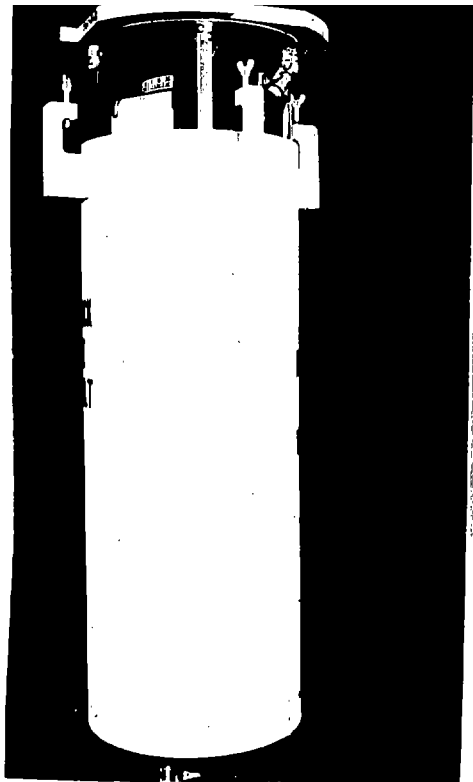

Unit Showing Can & Method of Sealing

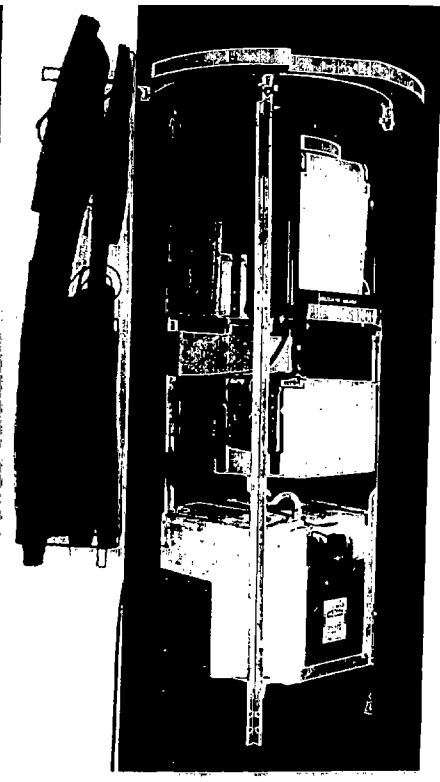

Recorder Side

UNCLASSIFIED

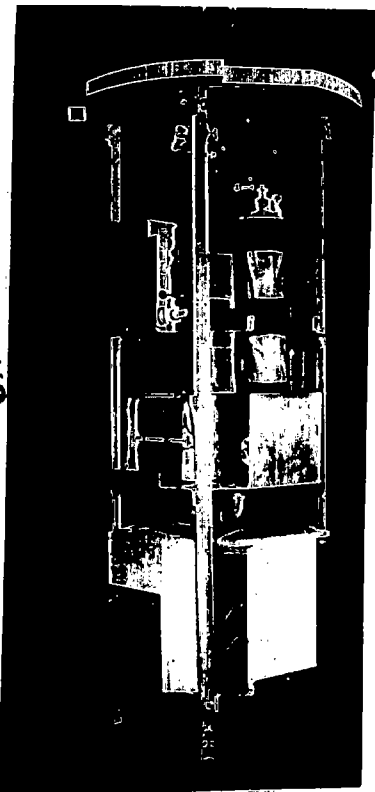

Chamber Side

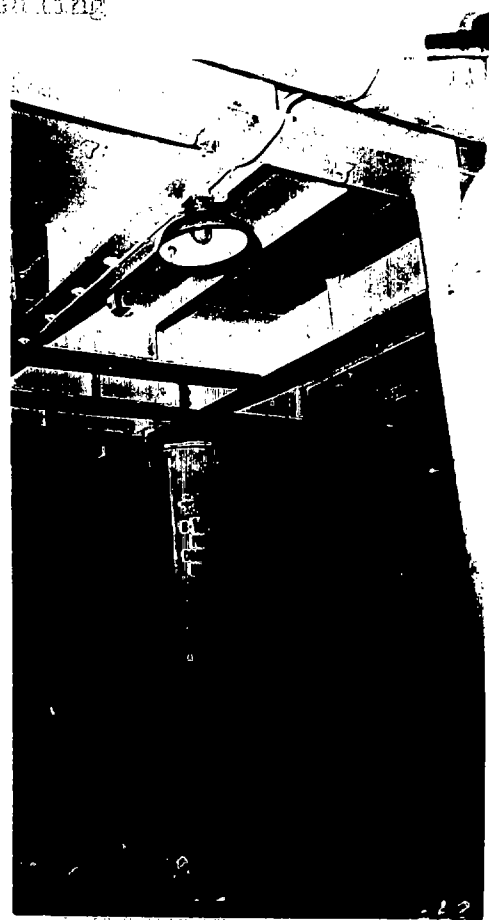

APA, 70 Carteret  
Installation in Troop Compt.



Nagato: Installation in  
Compt. behind open port.

UNCLASSIFIED

Fig. 2

UNCLASSIFIED

[REDACTED]

The suspension was formed from steel bar having a hinge allowing swinging in all directions in a horizontal plane. The direct transmission of shock down the suspension was reduced by interposing a layer of rubber between the blasing surfaces of the hinge, so that there existed no metal to metal contact between the two members across the hinge. An additional feature was the adoption of a lead strip spanning the hinge, which being flexed plastically by bending at the hinge, provided damping. This lead link was found to have worn out in some cases after the Able test, showing that much oscillation energy had been absorbed.

#### 6. Radio change speed control.

The change speed on the clock was activated by the movement of a small lever. This lever was held in the slow speed position by a fine steel wire link held in tension by a spring. When the relay contacts closed in the radio unit, this applied 18 volts to the steel wire, fusing it, and allowing the lever to move over to the high speed position.

#### Calibrations

Adjustment and the calibration of the current sensitivity of the amplifiers was made at 23 points covering the range  $4 \cdot 10^{-10}$  A to  $10^{-5}$  A corresponding to an anticipated range of R/hr on the chamber of 1 to 25,000 R/hr using the signal generator of Fig. 1b. Specimen curves for units #11 and #10 are seen in Figs. 3 and 4.

In order to minimize correction for battery decline, such a curve was run on each unit in its ship installations, 12 hours before the shot, and when possible, a similar record was made on each unit after the shot on reentry. After Baker, in some cases, the background contamination on the ship made it advisable to postpone these final calibrations until the unit had been removed from the ship and returned to the AV-14.

UNCLASSIFIED

UNCLASSIFIED

OR  
OUT

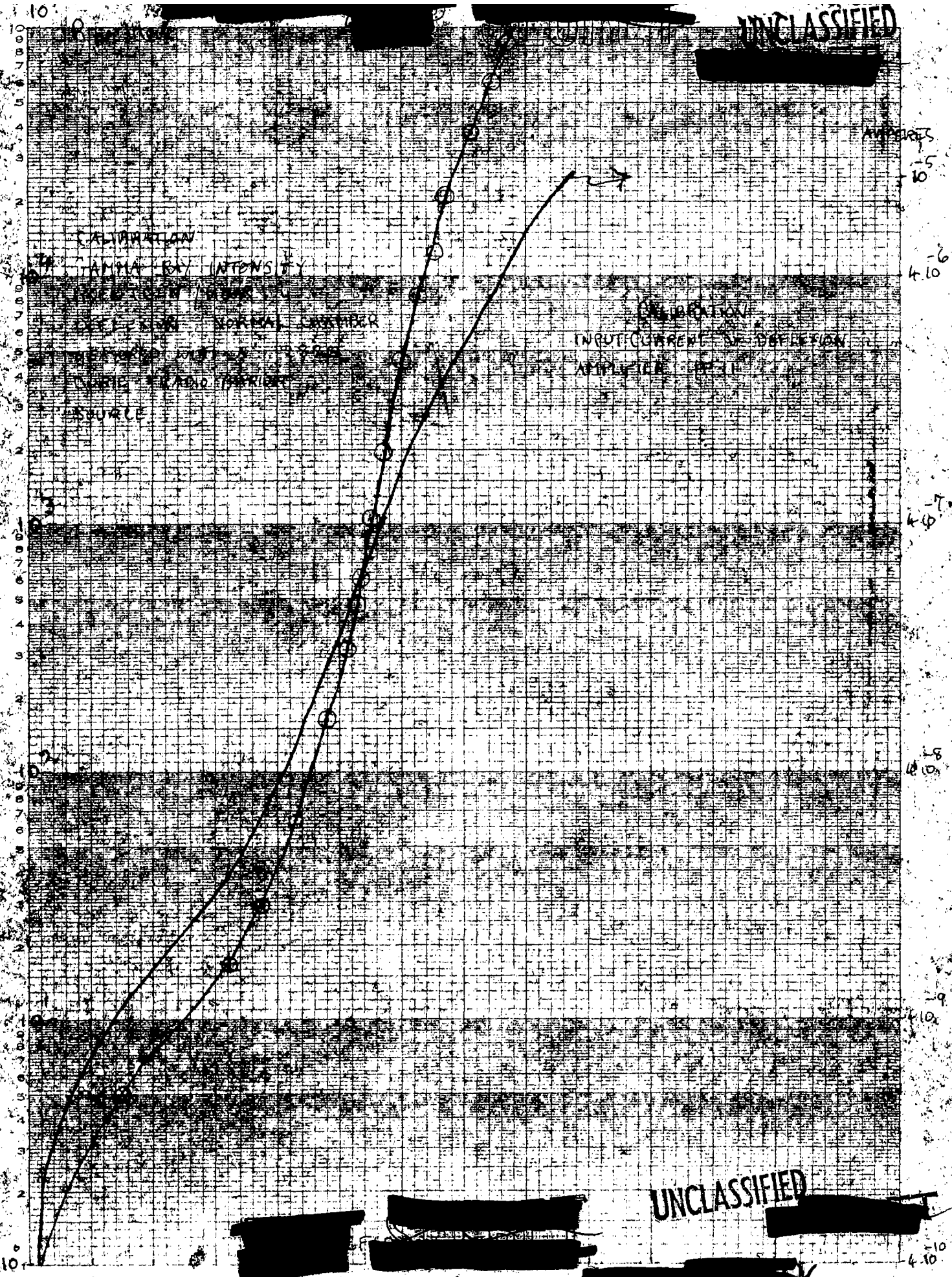

NO. 3000 S.I. DIEZEL-GRASS PAPER  
SERIALIZED BY  
GROUP 10 DIVISION

UNCLASSIFIED

UNCLASSIFIED

R. L. HUBB

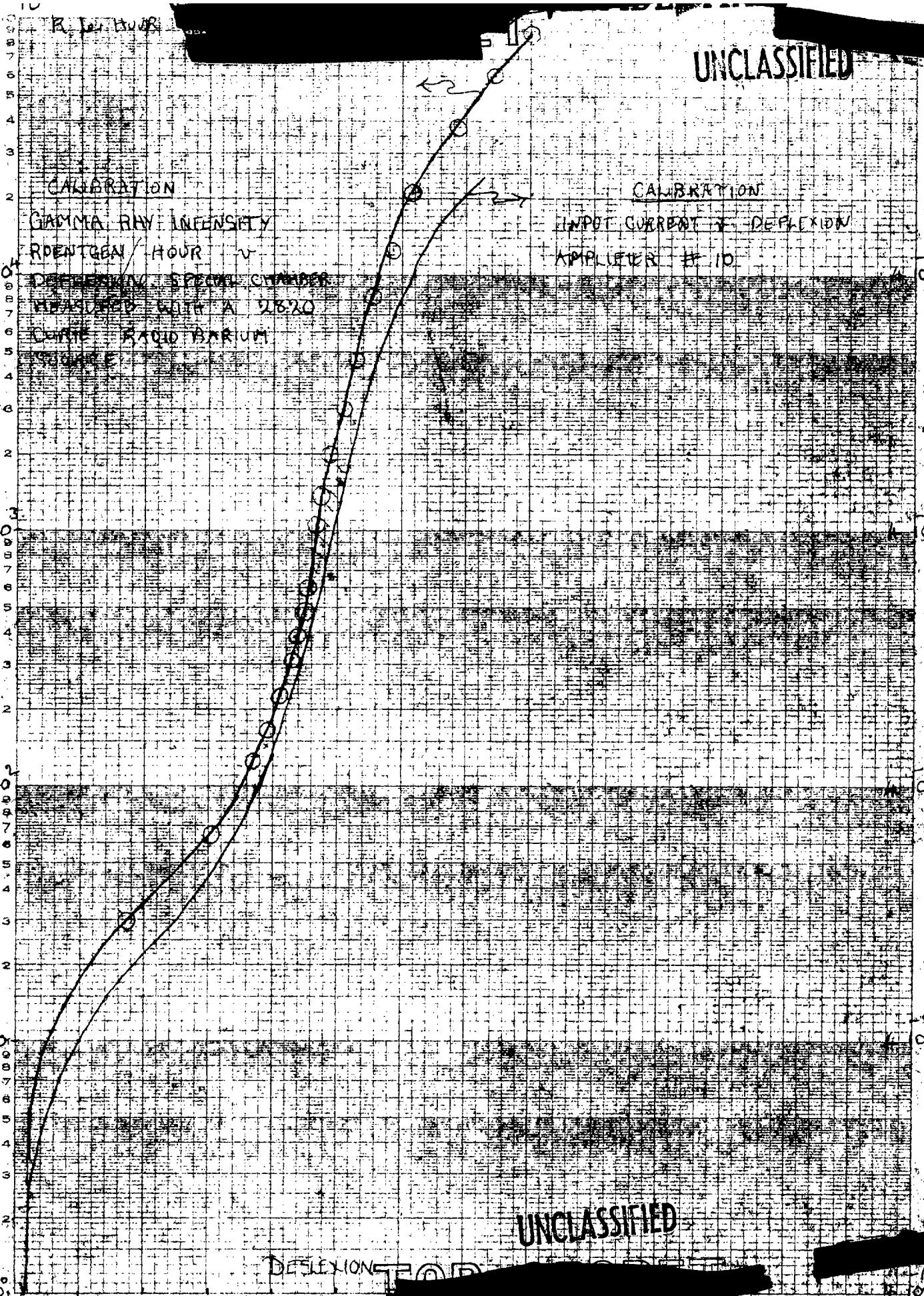

EUBENE DIETZGEN CO.

NO 340-LS10 DIETZGEN GRAPH PAPER  
SEMI-LOGARITHMIC  
5 CYCLES X 10 DIVISIONS PER INCH

UNCLASSIFIED

DEFLECTION

UNCLASSIFIED

order to keep the dosage of the operators within the legal gamma dose of 0.1 R per day. By reference to previously prepared curves of amplifier sensitivity against time, a small correction for battery decline, over the 12 hours interval between calibration and firing was applied.

#### Radiation Calibration

An accurate calibration at one intensity, 5.75 R per hr. was made on each completed unit, using a 2 gram source of radium, and making a direct comparison in each case with a standard Victoreen chamber mounted in a position as closely as possible coincident with the ionization Chamber of the unit. The results of this showed that the chambers were within the experimental error alike, all variations, from unit to unit, amounting to about 20% being accountable from variations in the previously made amplifier sensitivity curves.

In addition to the above, a calibration was made on one unit up to 100 R/hr. with 2 gm radium and using an inverse square law method.

It was our good fortune on return to Los Alamos to be able to make use of a 2620 curie Radio Barium-Radio Lanthanum source, supplied for the Rala experiment, to give a direct calibration at gamma ray intensities up to a maximum of 77,000 R/hr. The intensities were calculated using an inverse square law with an analytical correction for the finite chamber size at small distances, the source strength being measured both by the installed equipment of group M-2, and by standard Victoreen chambers at points where the gamma intensities due to the source were not too high to invalidate the standard chamber calibration.

UNCLASSIFIED

The resulting R/deflection curves are shown for standard and special chambers in Figs. 3 and 4, and the decline in sensitivity of the

UNCLASSIFIED

-9-

normal chamber at high intensities which was found, is plotted in Fig. 5. The special chamber development arose in the following way: As direct calibrations at high intensities were not expected to be available, calibration depended on the extrapolation from 100 R/hr. up to 100,000 R/hr., and misgivings being felt about the justification of such an extrapolation, in the time available between Tests Able and Baker, two chambers were modified to give higher collecting fields and lower charge densities. To do this, the central 15 mil wire was replaced by a 1 1/2" diameter cylinder and the gas pressure reduced from 3 to 1 atmospheres of A + 2 % CO<sub>2</sub>. The plan was to install these chambers having more linear characteristics alongside normal chambers, at selected points in Test Baker, in order to obtain a check on the calibration of the normal chambers at high intensities.

The availability of the 2800 curie source made this unnecessary, although the basis for the original misgivings is plainly seen to be justified from Fig. 5, in which at 77,000 R/hr the normal chamber sensitivity is seen to have declined by a factor of 20.

However the twin installations of normal and special chambers made in Test Baker provide a convenient check on experimental accuracy since both types of chamber being calibrated, the two records obtained, should yield identical intensity time curves. The extent to which this is true is seen in Fig. 7, where the the curve for the APA 77 upper installation which is a twin the points from both records are seen to lie close together. Another feature of this twin record is that the effects of ship motion on the recorders must have been small since they were mounted in such a way that the two recorders would have been affected dissimilarly by rolling and pitching. Only one such twin record was obtained since although

UNCLASSIFIED



APPARENT  
GAMMA  
RAY INTENSITY  
R/HA

SECRET

UNCLASSIFIED

EUGENE DILLIARD CO.  
MADE IN U.S.A.

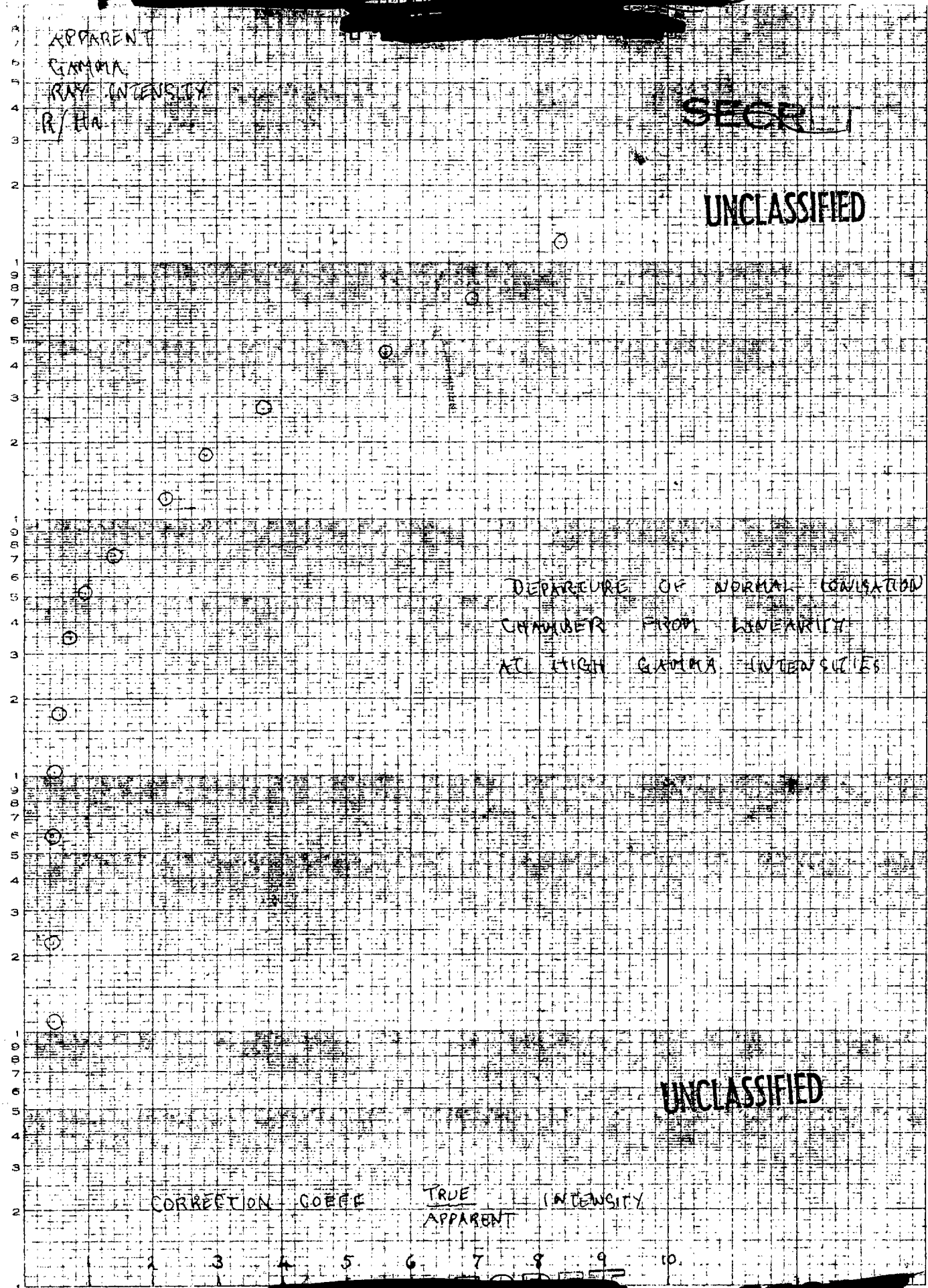

DEPARTURE OF NORMAL CORRELATION  
CHARACTER FROM LINEARITY  
AT HIGH GAMMA INTENSITIES

CORRECTION COEFF      TRUE INTENSITY  
APPARENT

UNCLASSIFIED

NO. 340-1510 DIETZGEN GRAPH PAPER  
SEMI-LOGARITHMIC  
5 CYCLES X 10 DIVISIONS PER INCH



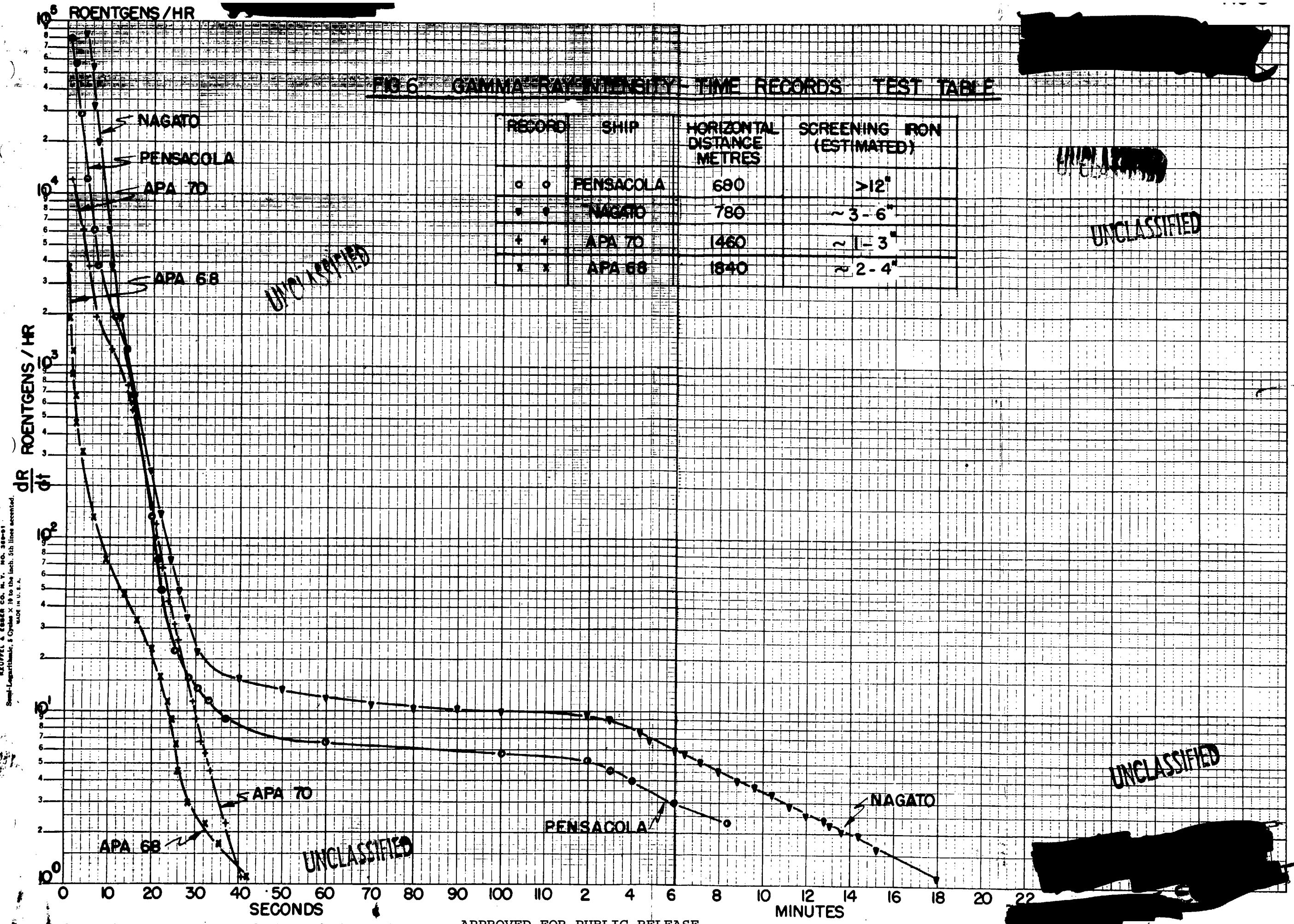

KEUFEL & ESSER CO. N. Y. NO. 35-5-51  
 Semi-Logarithmic, 5 Cycles X 10 to the Inch, 5th line accented.  
 MADE IN U. S. A.

UNCLASSIFIED

-10-

two twin installations were made, the normal unit of the other pair gave no record on account of an ink failure.

### Clock Calibration

The chart speeds of all the recorders were checked at low and high speeds and found to be within 5% of rated values except with nearly run down springs. This latest reservation does not affect any of the useful parts of the records obtained in Tests Able and Baker.

### Installational

#### 1. Test Able

In general, the plan for ABLE included installations at various distances from the target point, on an E-W line up and downwind of the burst. The units were not intended to withstand the direct blast pressure from the bomb, at operating distances, and were therefore always installed in closed ship compartments. These locations were chosen to have as far as possible light and calculable screening between the unit and the bomb.

In fact, the unexpected point of detonation in ABLE increased the screening in most cases, especially on the Pensacola and Nagato. A deep installation, coinciding with a below deck installation on the APA 69, was intended to detect water screening effects, but this ship was sunk.

Installational data for ABLE is given in Table I.

#### 2. Test Baker

Profiting from the lessons of Test ABLE, installations in Baker were modified to reduce the uncertainty of screening.

UNCLASSIFIED

In the downwind APA upper locations, units were placed far forward in the bows, ie, in the part of the ship nearest to the bomb in order

that the interposition of heavy ship machinery should be minimized. Also, a deep installation was made on APA 70, as far down, and as nearly vertically below the upper installation as possible, with a view to detecting water screening and water contamination effects.

This latter installation, though difficult to service on BAKER minus one day, on a battened down and abandoned ship, yielded an acceptable record. It would be idle to enlarge on the installations which were lost due to sinking, although it is to be regretted that the installation in the interior of the Nagato Turret, having 11" of armored screening, together with its lightly screened companion on the same ship, were not recovered. Installational data for BAKER are given in Table 2.

Table I. Installational Data. Test ABLE

Pensacola.	CA-24. Cruiser. Approximate bearing of bomb with respect to ship, 150 degrees. Horizontal distance from bomb. 680 meters. Upwind from bomb. In compartment A-203-3L. Officers Galley Estimated screening - 2 barbettes - 12" steel Radio controlled unit.
Nagato	Heavy Battleship. Approximate bearing bomb with respect to ship, 180 degrees. Horizontal distance from bomb 780 meters. Upwind from bomb. In starboard side of after tower on O1 deck, frame number 190 Estimated screening - tower members 3"-6" steel. Radio controlled unit.
APA 70 Carteret	Troop Transport. Approximate bearing bomb with respect to ship, 190 degrees. Horizontal distance from bomb, 1460 meters. Upwind from bomb. In after troop berthing compartment number 1-134-1, c-201-L on centerline. Estimated screening - oblique bulkheads and pipes 1" -3" steel
APA 68 Butte	Troop Transport. Approximate bearing bomb with respect to ship 90 degrees. Horizontal distance from bomb, 1840 meters. Downwind from bomb. Installation as on APA 70 Estimated screening - bulkheads and pipes. 1"-2" steel.

UNCLASSIFIED

UNCLASSIFIED

Table II. Installational Data. Test BAKER

APA 70 Troop Transport. Bearing of bomb - not known but ahead.  
 Crittenden Horizontal Distance from bomb, 1340 meters.  
 Downwind from bomb.  
 In forward Troop Head. 1-17-1 - A - 1021-L port side.  
 Estimated screening - 1"-2" steel.  
 Radio controlled unit.

APA 70 Troop Transport. Bearing of bomb - not known but ahead.  
 Carteret Horizontal distance from bomb 1840 meters.  
 Downwind from bomb.  
 Same location as above,  
 Estimated screening - 1" - 2" steel.  
 Radio controlled twin unit installation  
 Also:  
 Forward GSK stores. 9' below water line  
 Uncontrolled unit.

Table III. Able Test

Ship	Pensacola	Nagato	APA 70	APA 68
Distance from Bomb in meters.	680	780	1460	1840
Total dose in R by integration of our I(t) curve, using theory for 0-2 sec.	77	280	17.2	1.6
Open air dose as calc. from radiological film results (Dessauer)	5400	2900	130	27
Factor: <u>Outdoor film dose</u> - € our dose	70	10	7.6	16.8
Calc. screening thickness of iron for above attenuation taking 1/e thickness as 1.5"	6.5"	3.6"	3.1"	4.2"
Approximate actual screening in inches Fe	12"	3"-6"	1"-3"	2"-4"

UNCLASSIFIED

UNCLASSIFIED

Table IV. Baker

Ship	APA 77 Upper Location	APA 70 Upper Location	APA 70 Deep Location
Distance from Bomb in meters	1340	2680	2680
Total dose in R by integration of our I(t) curve. No theory and neglecting small initial burst	90	31.8	12.6
Total dose from accompanying radiological films (Dessauer)	—	30	15
Approximate screening in inches Fe	1"-2"	1"-2"	3/8" sea water

Results:Test ABLE.

Of the 8 installations made for test "ABLE" four records were obtained, yielding the final results plotted in Fig. 6. (The missing records were accountable as follows--2 by sinking, 1 recorder damaged by shock, 1 loss by battery failure.) For all four recorders the radio control was successful, using the putative minus 20 second time signal which actually turned on the units at minus 3 seconds.

(Experiments were made subsequently, to determine whether this allowed enough time for the chart to reach full speed before detonation, which was found to be the case)

The rate controlling factor in unit response was the recorder movement with a time constant of 0.2 seconds and since the latter was almost critically damped, the records as given should be taken to be significant (that is within a few percent of equilibrium) at times from 1 second after the detonation.

UNCLASSIFIED



**UNCLASSIFIED**

**1977 GAMMA RAY INTENSITY TIME RECORDS - TEST BAKER**

RECORD	SHIP	HORIZONTAL DISTANCE (METRES)	SCREENING (ESTIMATED)	IRON LOCATION IN SHIP	SPECIAL CHAMBER
1	APA 77 (CATTINDEN)	1570	1 1/2	1 DECK FORWARD TROOP HEAD	SPECIAL CHAMBER
2	APA (CARTERET)	2740	1 1/2	1 DECK FORWARD TROOP HEAD	TWIN INSTALLATION x x SPECIAL CHAMBER
3	APA 70 (CARTERET)	2740	3/8 HORIZONTAL + SEAWATER	FORWARD STORES 9' BELOW WATER LINE	△△ NORMAL CHAMBER
					NORMAL CHAMBER

THESE SHOULD BE IDENTICAL

DR ROENTGEN / HR

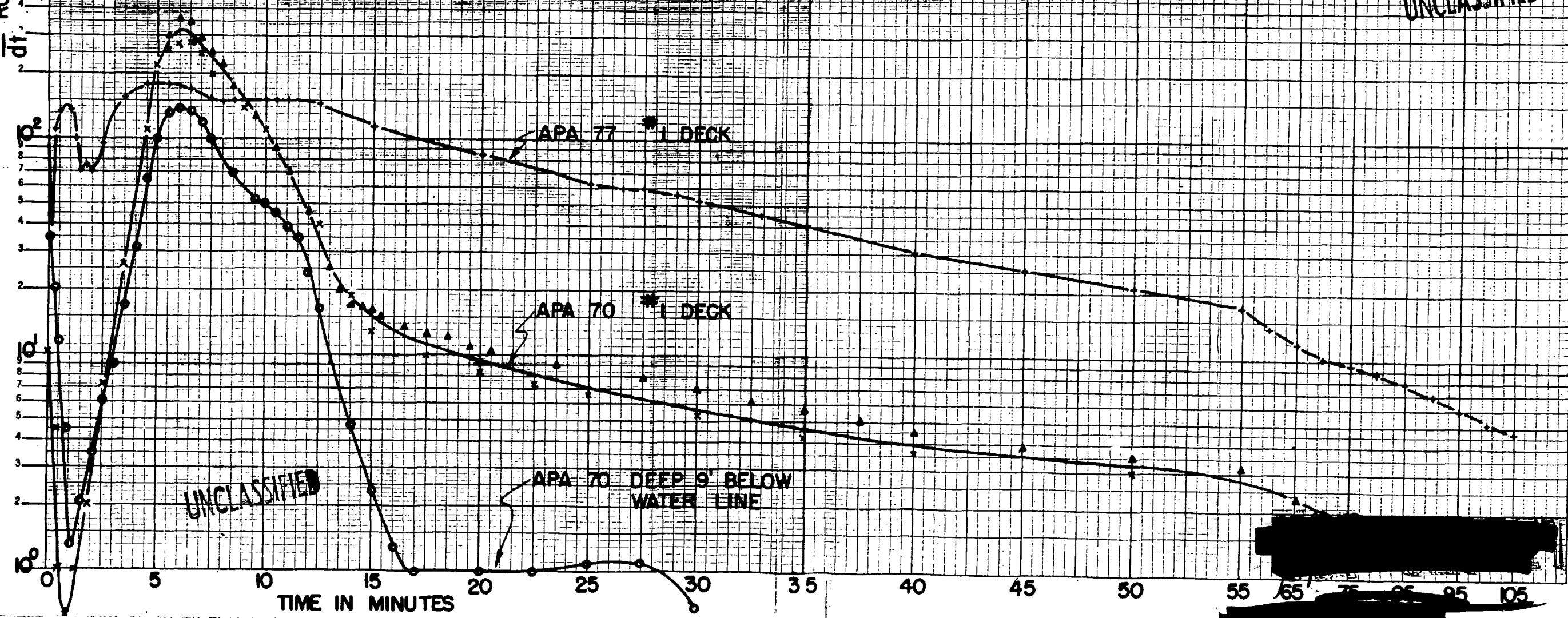

KEUFFEL & ESSER CO. N. Y. 100-100-1  
Serial-Logarithmic, Cycle X-10 to the Inch, 1/4 inch diameter  
MADE IN U. S. A.

UNCLASSIFIED

In general, the records show a rapidly falling gamma ray intensity for the first twenty seconds followed by, in the case of the two nearer-in ships, an abrupt flattening out to a decay with an approximate half life of 5 minutes.

The early part of the curves shows an oscillation of small amplitude with about the same time period as the roll of the ships. As it occurs too early to have been produced by waves, it may be due to the motion of the ships produced by the air blast. Such motion would introduce variations in gamma ray screening at various points in the oscillation.

The most uncertain factor in calculating from these curves is the screening by the ships, and the estimates given for the iron screening therein, in Table 3, are approximate being arrived at from tape measure and ruler measurements on the ships. The unexpected point of detonation in Test "Able" resulted in the major part of the Pensacola structure and turrets being interposed between bomb and unit, and a steel tower structure of uncertain thickness on the Nagato. The heavy screening on the Pensacola at 680 meters is seen to be effective in reducing the intensity observed there below that on the Nagato at 780 meters.

These effects are discussed more fully later.

#### Results:

#### Test BAKER.

Of the 9 installations made for "Baker" four records were obtained, yielding the final results plotted in Figs. 7 and 27a. (The five missing records were accountable as follows:-- 2 on Nagato which sank before cleared by Radiological Safety; 1 on Apogon, sunk; 1 on Crittenden; battery failure; 1 on Cartaret; ink failure.) Both radio controls were successful.

UNCLASSIFIED



10<sup>5</sup> ROENTGEN / HR

EARLY PART OF RECORD  
SHOWING INITIAL BURST  
SAME SCALE FIG 6

UNCLASSIFIED

KEUFFEL & ESSER CO., N. Y. NO. 5000-1  
Semi-Logarithmic, 5 Cycles X 10 to the Inch, 2 1/2" High  
MADE IN U.S.A.

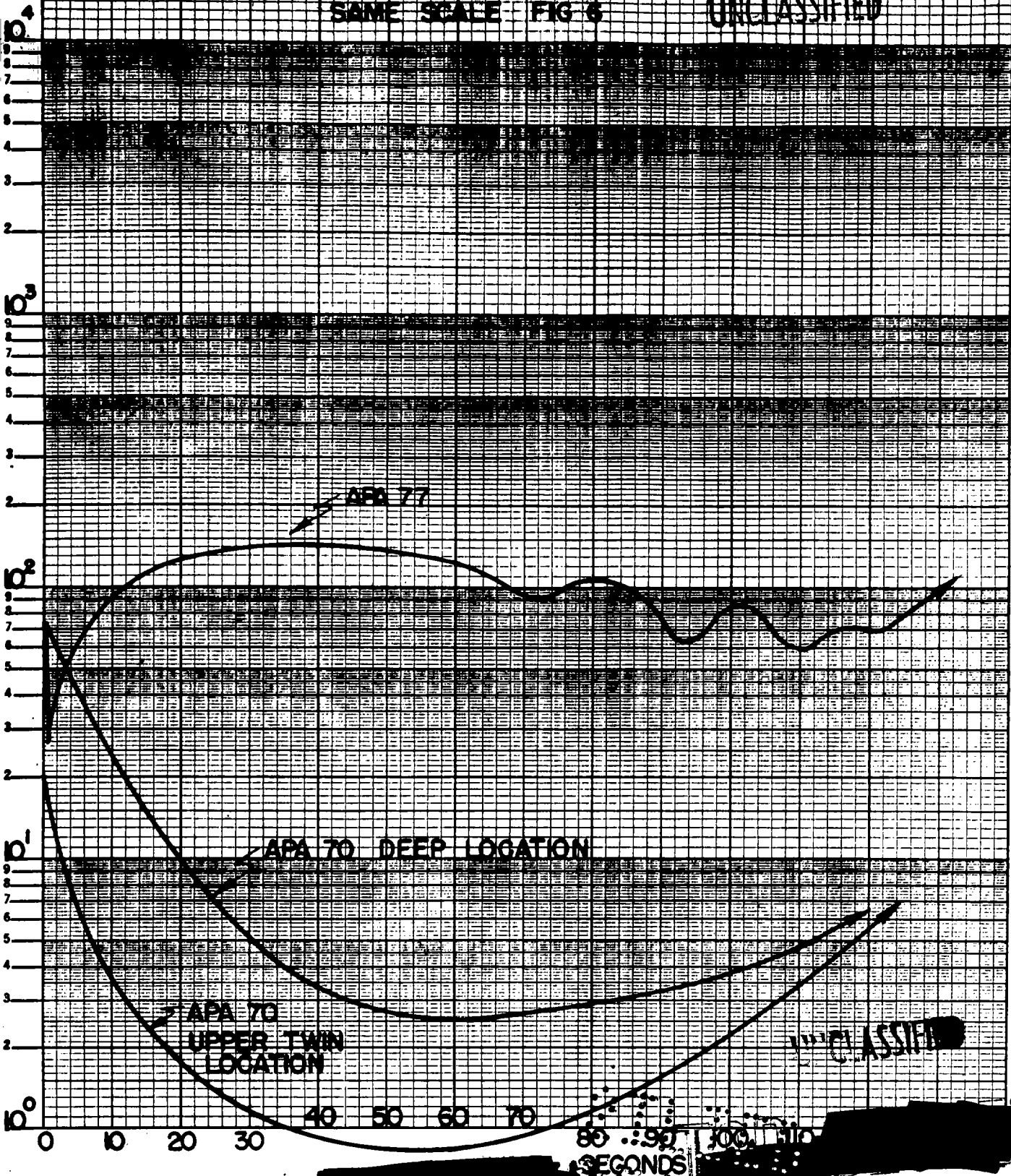

UNCLASSIFIED

SECONDS

APPROVED FOR PUBLIC RELEASE

UNCLASSIFIED

In general, the records show that the initial gamma ray burst which contained all the dose in test "Able", was smaller making a negligible contribution to the total dose. The records all showed a minimum within the first two minutes, which was as low as 0.5 R/hr on the Cartaret at 3000 yards, followed by a slow rise and flat maximum at 5 minutes of the order of 200 R/hr in magnitude preceding a slow decline, all falling below 10 R/hr after 2 hours.

It is noteworthy that when these ships were boarded, 4 days after Baker Day, although the gamma ray contamination level on deck was 0.5-1 R/hr on Cartaret and 1 to 2 R/hr on Crittenden immediately below deck, except where infiltration had taken place, the gamma ray contamination was 0.1 R/day or less. A pool of water lodged in a depression on the deck of the Crittenden had 12.R/hr.

Conclusions:

By assuming that the main origin of the observed gamma radiation is the emission of delayed gammas from the fission products of the bomb, which behave as a point source rising in the ball of fire, together with a knowledge of the air absorption efficient of the radiation, it is possible to calculate an intensity time curve.

If such curves are calculated, for the four experimental distances used in Test ABLE, four curves are obtained which agree very well in slope with the experimental observations from 1 second to about 20 seconds, (which interval covers the main part of the dose in Test ABLE). The theoretical open air intensity curves so calculated, lie from 60 to 70 times higher in magnitude than the observed curves, on account of the neglect of screening by the ship. This is not known very well, especially as when attempts were made to estimate it, difficulties were always encountered with highly variable absorbing objects such as pipes and winches,

UNCLASSIFIED

UNCLASSIFIED

-16-

[REDACTED]

which could vary the result by a factor of ten.

It seems possible to go some way to avoid this difficulty by making use of the Radiological film data.

In Test BAKER, by which time better liaison had become established, Radiological films were placed in coincidence with the ionization chamber on some units. Integration of the gamma intensity - time curves obtained from such units, gave total doses in good agreement with independent measurements made by the Radiological Safety Section on the films (table 4), so that it became clear that the two methods were using consistent units.

Since the theoretical  $I(t)$  curves were in good agreement in shape with experiment, over the interval 1-20 seconds, the assumption was made that this agreement was maintained in the interval from 0-1 second, so that it became possible to obtain a figure for the total dose,  $\int_0^{\infty} I(t)dt$  by using the theory for the gap from 0-1 seconds, not recorded by the units, and integrating the experimental curve from 1 second to infinity. The resulting total doses are tabulated in Table 3, and are seen to be less than the outdoor film doses by a large factor. This factor is taken to be the attenuation factor for the ship screening, which expressed in terms of inches of iron, using a mean free path in iron of 1.5", is seen to be in the region of the estimated actual ship screening.

The resulting attenuation factors, when used in conjunction with the factors, when used in conjunction with the theoretical outdoor  $I(t)$  curves, is seen (Fig. 8) to bring the theory into fair agreement with experiment for ABLE.

[REDACTED]

UNCLASSIFIED

SEMI-LOGARITHMIC  
5 CYCLES X 10 DIVISIONS PER INCH

### FIG 8 EVASIVE ACTION CURVE

SHOWING % DOSE RECEIVED UP TO TIME "t" AFTER BURST

$$y = 100 \frac{\int_0^t D(t) dt}{\int_0^{\infty} D(t) dt}$$

% WHOLE DOSE

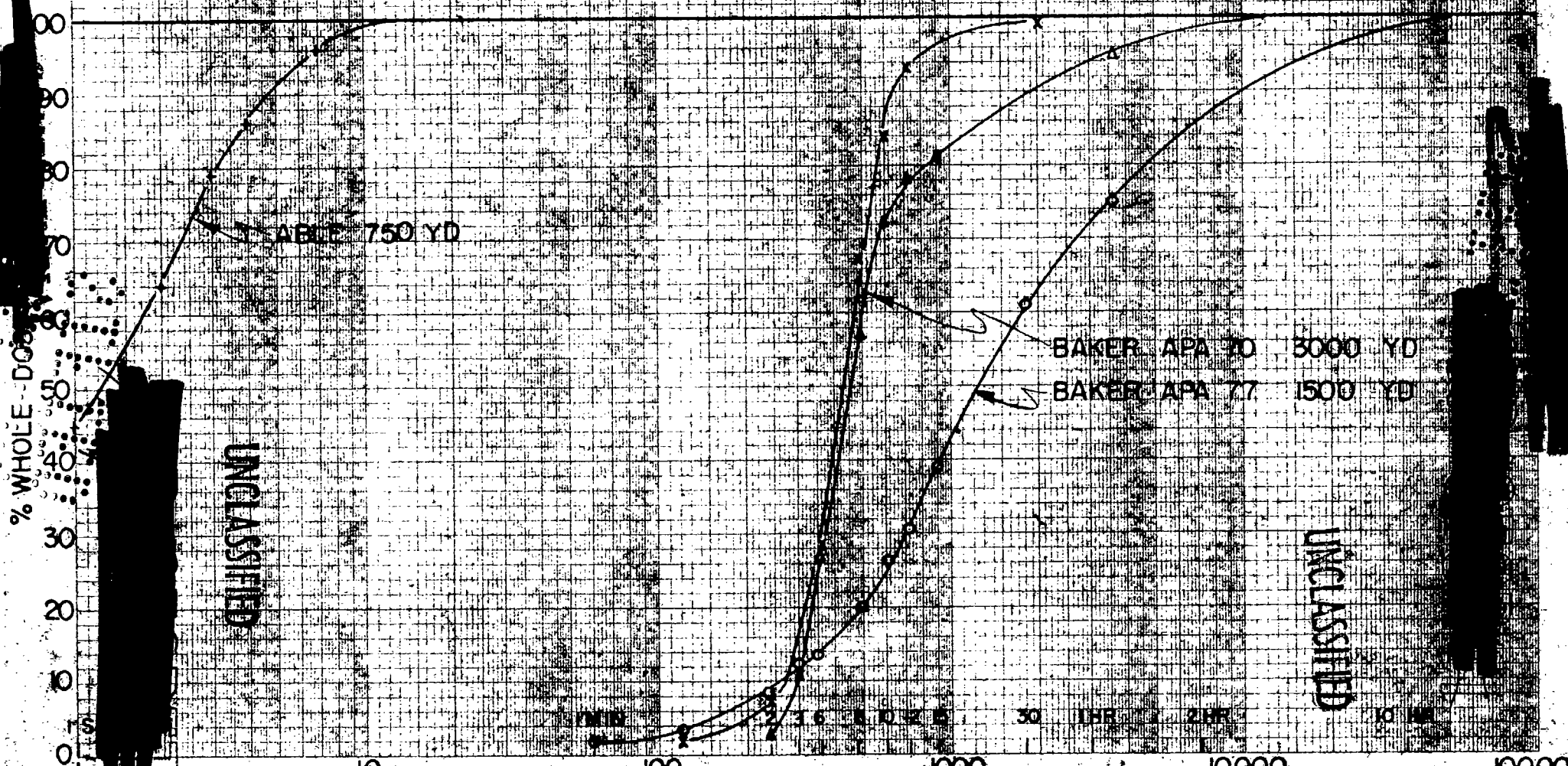

UNCLASSIFIED

UNCLASSIFIED

APPROVED FOR PUBLIC RELEASE  
TIME AFTER DETONATION t IN SECONDS

FIG 8

UNCLASSIFIED

-17-

The rapid fall in gamma ray intensity, which continues right down to very low values in the two more distant ships, shows a sudden and similar tailing off on the nearer in ships, at 20 seconds after detonation, to a lower rate of decay, of half life about 5 minutes. The presence of this effect on the nearer in ships and absence from the far out ones suggests that it arises from neutron induced activities though this hypothesis meets with a difficulty. The magnitude of this effect on the two ships, appears to be in scale with the gamma ray intensity which is attenuated much more on the Pensacola ( $\sim 70$  times) than on the Nagato ( $\sim 10$  times). However a neutron induced radiation would, on account of the diffusion properties of slow neutrons, not be expected to be eliminated but be able to reach the chambers laterally, where the screening in both cases is much less. Hence if the 5 minute decay were slow neutron induced, it would be expected to be proportionately much higher on the Pensacola, unless some local vagary of distribution of the neutron capturing material introduced a compensating effect. It is not possible to explain the effect in terms of a tail of fission products behind the ball of fire, emitting gammas, since it is absent from the farther out ships. An explanation may perhaps be found in terms of fast neutrons, which would be more directional than slow.

In the BAKER records (figs. 7, 7a) the initial burst of radiation analogous to that in ABLE, is quite small in magnitude. In the case of the distant Cartaret at 2700 meters (3000 yards), the intensity falls rapidly as in ABLE to a low value at 40 to 50 seconds, rises to a maximum at 5 minutes, and then declines slowly.

UNCLASSIFIED

It seems straight forward to explain the maximum and subsequent decay in terms of a high local concentration of fission products either

UNCLASSIFIED

UNCLASSIFIED

-18-

brought down in the descending rain and in the rolling cloud of spray which spreads out from the base of the plume. These fission products then decay and remove themselves by running off the ship and by diffusing down through the sea water.

It is interesting to speculate on the meanings of the above and below water line readings on the Cartaret. The two records are closely similar in the shapes and times of their record maxima, the below water line record not lasting so long or rising so high, and having about half the total dosage of the upper location record. The locations are almost vertically one above the other, about 40 feet and 4 steel decks apart. There is a flat deck a few feet above the upper location, that it would be affected by deck contamination by something like an order of magnitude more than the lower. It seems likely therefore, that ship contamination is not the main factor in the doses, but that a large proportion of it originates from fission products in the surrounding mist and on the water surface. The slight secondary maximum, on the underwater record, after the main maximum, which is absent on the location record, is suggestive of some downward diffusion of the fission products through the water, past the unit.

The Crittenden instrumental record (1500 yds.) obtained in Baker gives evidence of very strong vibrations lasting about ten seconds, the pen being in rapid motion and producing a series of dots. There is a similar weaker effect on the Cartaret records starting at  $\frac{1}{2}$  second and much briefer. The under water shock must have caused this, and the small minimum on the Crittenden curve at  $< \frac{1}{2}$  second is probably instrumental from the same cause. There appears also a marked oscillation on

UNCLASSIFIED

UNCLASSIFIED

-19-

this curve at 90 seconds, corresponding to the expected time of arrival of the first water wave from the explosion.

By plotting the integral of the ABLE and BAKER curves up to time "t", as a percentage of the total integral fig. 9, one obtains a curve which shows the percentage reduction in dose resulting from dodging behind a strongly absorbing shield. About  $\frac{1}{2}$  the total dose is obtained in the first second, in ABLE, is that very prompt action would be needed to reduce the dose to say, 300 R at 1500 yards in ABLE to 150 R. The Pensacola screening result suggests that all round shielding is not required, scattering being small.

In Baker however, the time to half dose is much longer, varying from 20 minutes at 1500 yards to seven minutes at 3000, which may give time for ship evasive action. In this case, the radiation will be fairly isotropic, so that all round screening would be required.

Group Personnel:

Harley Gabrielson

James L. Tuck

Roger White

Lennie Whitworth

UNCLASSIFIED



10<sup>5</sup> ROENTGEN / HR

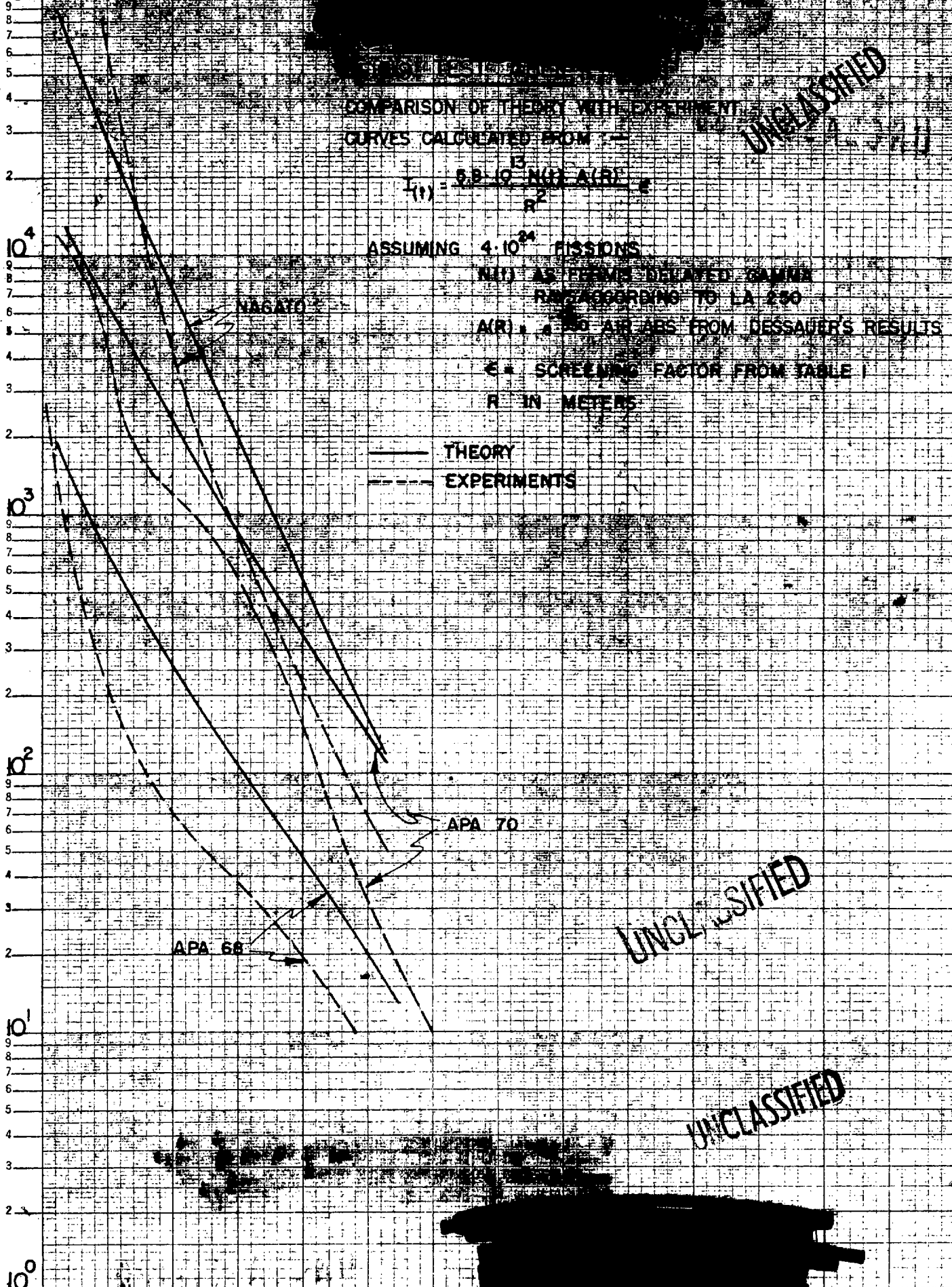

UNCLASSIFIED

UNCLASSIFIED

UNCLASSIFIED

KEUFFEL & ESSER CO., N. Y. NO. 389-91  
Semi-Logarithmic, 5 Cycles, 10 mm for the inch, 5th line accepted.  
MADE IN U. S. A.

APPROX SECONDS





UNCLASSIFIED

UNCLASSIFIED

DOCUMENT ROOM

REC. FROM LB  
DATE 11/21/47  
REC. NO. ✓

UNCLASSIFIED

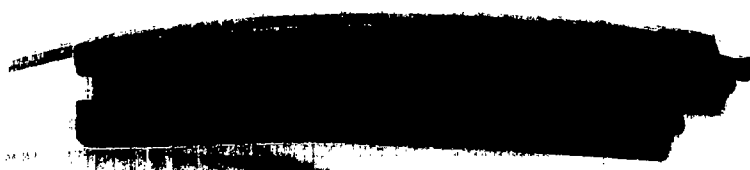

UNCLASSIFIED

UNCLASSIFIED  
UNCLASSIFIED

UNCLASSIFIED  
APPROVED FOR