

CIC-14 REPORT COLLECTION
REPRODUCTION
COPY

C.3

LOS ALAMOS SCIENTIFIC LABORATORY

OF THE UNIVERSITY OF CALIFORNIA
LOS ALAMOS, NEW MEXICO



CONTRACT W-7405-ENG.36 WITH THE
U.S. ATOMIC ENERGY COMMISSION

LOS ALAMOS NATL. LAB. LIBS.
3 9338 00353 5555

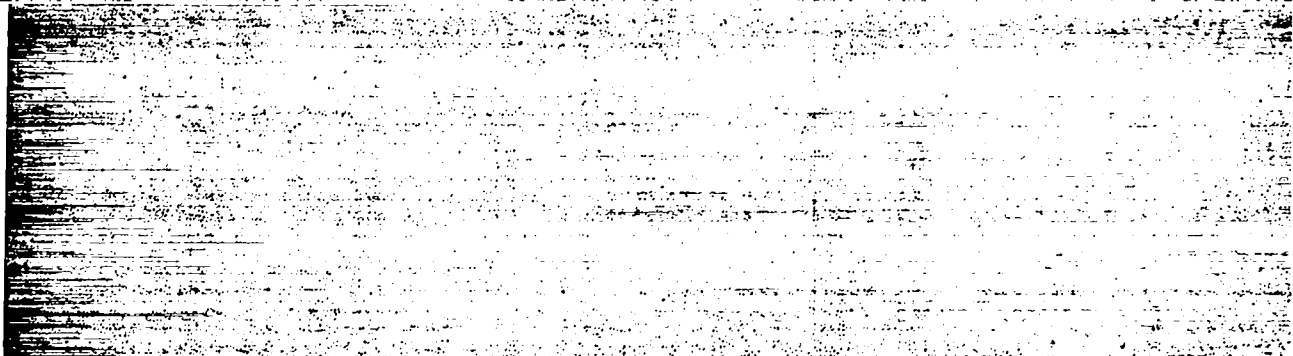

C 6

LOS ALAMOS SCIENTIFIC LABORATORY
of the
UNIVERSITY OF CALIFORNIA

Report written:
April 1955

Report distributed: JUN 30 1955

LA-1909

INSTRUMENTS FOR THE MONITORING
OF TRITIUM IN THE ATMOSPHERE

by

B. C. Eutsler
G. L. Evans
R. D. Hiebert
R. N. Mitchell
Chain Robbins
R. J. Watts

INSTRUMENTATION

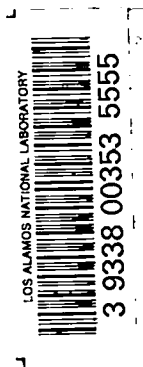

ABSTRACT

Three types of instruments, all operating on the same principle, are described. These are a battery operated type, an AC operated linear type, and an AC operated logarithmic type.

The current from a conductivity type chamber is monitored by a simple electrometer tube circuit. A warning bell is rung by means of a sensitrol relay when ionization in the atmosphere produces a full scale reading. These instruments are intended for special situations where the environment can be controlled to some extent. They will respond to ionization arising from any source. A full scale reading on the most sensitive scale is equivalent to a current of 10^{-12} amp in the chamber.

Curves are given of the behavior of this type of instrument with flow rate, tritium concentration, equilibrium time, voltage ion traps, and tritium in the form of HT and HTO.

It is concluded that these instruments are satisfactory as warning devices but are of doubtful value as health tolerance meters.

ACKNOWLEDGMENT

The authors wish to thank Edwin Bemis for pointing out to them the importance of the "equilibrium time."

INTRODUCTION

It is desirable to have a monitoring instrument for tritium in the atmosphere which is relatively inexpensive, portable, and has an unambiguous response to tritium. The low energy of the tritium betas, however, makes the design of such an instrument a difficult task. Extremely thin windows are difficult to produce, besides being fragile, and any attempt to filter the air before passing it through a conductivity type chamber inevitably leads to complications in the sense that the instruments must be more sensitive than would be necessary for unfiltered air and that the response time of the instrument may be increased.

The following described instruments are somewhat of a compromise in these respects. They will respond to ionization from any source; therefore, it is necessary for the operator to have control over other sources of ionization, such as Bunsen burners. Tritium systems, however, are usually enclosed in glass or plastic hoods or containers so that an instrument that is small enough to go into these containers will alleviate this difficulty.

Because of many factors, these instruments are not satisfactory as a means of indicating quantitatively the amount of tritium in the atmosphere. They are intended to be used as a warning device with sufficient sensitivity to respond in the neighborhood of tolerance.

Conductivity chambers and the ionization in the atmosphere have been investigated for many years.¹ Therefore, it is well known that the resistance of dry air is somewhere in the region of 10^{15} to 10^{16} ohms, although this may vary over very wide ranges depending upon many factors.

Inasmuch as it has been found that the tolerance concentration of tritium in the atmosphere will, with these chambers, give currents of the order of 10^{-12} amp, it has been concluded that it is possible to monitor successfully for tritium in the atmosphere at close to tolerance amounts. However, it can be shown that it is possible for the instrument, under certain atmospheric conditions, to be in error by a factor of 3×10^3 .

With a large number of instruments in operation, this condition has never been encountered and, therefore, it was concluded that although the instrument is not suitable as a health instrument, it has great practical utility as a warning device as has been amply demonstrated in actual use.

CIRCUIT

Figure 1 is a circuit of the Los Alamos Model 101 partially portable air sampler which is generally described as a "Sniffer." This circuit has been described in Elmore & Sands.² Use is made of a type 5800 electrometer tube to measure full scale ionization currents from 10^{-12} to 10^{-9} amp in four linear ranges. Maximum current amplification is 2×10^7 and the output is fed to a sensitrol relay which sets off an alarm when full scale reading is reached.

This instrument has a battery operated circuit and an AC blower and alarm system. Battery life under continuous operation is six months. It is possible to make this version fully portable by means of a DC motor and a 6-volt "hot-shot" battery.

A picture of this air sampler is shown in Fig. 2. The electrometer tube, range switch, and resistors are housed in a moisture proof cylindrical housing. The feedthrough from the ionization chamber is by means of a teflon disc with a guard ring pressed into the surface. Figure 3 is a full scale drawing of the arrangement.

Figure 4 is a schematic of the fully AC operated Model 110. This circuit makes use of a simple rectifier power supply, glow-discharge tube regulated, to supply circuit power. The electrometer tube operates under nearly the same conditions as in the Model 101 circuit, with zero signal plate current of $10 \mu\text{amp}$; plate voltage of 4.5 volts, and signal grid bias of about 3 volts. The alarm is actuated either by full scale swing of the sensitrol relay in the electrometer plate circuit or by failure of the electrometer tube resulting in the energizing of relay K-102.

This air sampler is built in the same size package as the battery operated instrument, but it weighs 7 lb less.

Figure 5 shows the circuit of a multi-station logarithmic air sampler (Model 126) designed to drive two paralleled multi-point Brown recorders. This instrument samples air conductivity at six remote stations, the most distant sampling point being 125 ft from the central power and control panel. Each station has logarithmic response over a chamber current range of 10^{-12} to 10^{-9} amp, thus compressing all scales of the Model 101 into one range. Slight adjustment of electrometer plate voltage matches sensitivity of each station to that of the others. Logarithmic response is obtained by the diode section of the 5803 electrometer grid when it draws current. Thus the current gain of the circuit varies from 7.5×10^6 with a chamber current of 10^{-12} amp to 5×10^4 with an input current of 10^{-9} amp. Provision is made for a microswitch on one recorder to lock in an alarm relay when any station reaches a predetermined conductivity level.

PERFORMANCE

Although these instruments were designed primarily as alarm devices, it was important to investigate their behavior in terms of tritium concentration.

The generation of a known concentration of tritium was accomplished by saturation of an air stream with water containing a known amount of tritium.³ Gaseous tritium was generated by passage of this air stream through metallic zinc at high temperatures.

Figure 6 is a schematic drawing of the calibration equipment. The direction of air flow is indicated by the arrows. The stream of air, or nitrogen (K), was passed through a rotameter (E) at a constant back pressure reading (manometer F) and dried in a calcium chloride drying tower (G_1). The dried air was saturated with water containing tritium oxide by passing it through fritted glass bubblers (J) at a constant temperature. The saturated air next flowed through the by-pass (H), or through the zinc furnace (I) when gaseous tritium was desired, and into the mixing chamber (M).

The diluting air was supplied by a Sutor-Bilt pump (O). The diluting air volume was controlled by a bleeder valve (N) and measured by an orifice meter (L). When dry air was used, the known volume of diluting air was dried in a calcium chloride drying tower (G_2). When high humidities were desired, this same tower could be converted to a humidifier by filling it with wet glass wool. The diluting air, dried or humidified, then passed into the mixing chamber (M) where it was mixed with the air containing tritium.

This mixed air, of known volume and tritium concentration, passed from the mixing chamber directly through the monitoring device (C), or if desired, could be held an extra length of time in a by-pass consisting of two 55-gal drums (D). For certain information, the tritium water vapor was collected in the liquid air traps (B). The entire system was exhausted through a 4-in. duct (A) into the room hood. Figure 7 is a photograph of the equipment (without the liquid air traps).

In the calibration of the Model 101 Sniffer, one of the most stubborn problems to be overcome was the buildup of static charge on the glass mixing chamber. This phenomenon caused the mixing chamber to act as an ion trap. The difficulty was overcome by wrapping the chamber with aluminum foil and suitably grounding it.

The preliminary calibrations were confusing because the concentrations of tritium necessary for instrument readings did not agree in orders of magnitude with previous theoretical calculations or with a rough calibration performed in 1951. It was then observed that the "hold time" from the generation of tritium to the passage of tritium-contaminated air through the Sniffer was of utmost importance. An equilibrium concentration of ions was not being realized in the 1.9 sec that the tritium contacted the air before passage through the ion

chamber. Wait and Parkinson⁴ have experimental data to show that the mean life of both small and large ions in the atmosphere will range from 5 to 20 min. (The mean life of an ion is the average time interval between formation and recombination of the ion.) Figure 8 shows a plot of Sniffer readings for given concentrations of tritium against "hold time" in seconds. The hold time was varied by means of two 55-gal solvent drums with a combined volume of 0.4 cubic meter. The mixing chamber volume was 0.012 cubic meter, and by means of valves the ionized air at a given rate of flow could be held for three lengths of time, i.e., in the mixing chamber and in one or both 55-gal drums.

For convenience, 85.9 sec was the time selected as the point to make all the calibrations. Figure 8 shows that this time represented more than 80% of the ionization equilibrium condition. All the calibrations with the Sniffer were performed at an air flow rate of 0.3 cubic meter per minute. This is the normal rate of air flow for the fan now being used on the Sniffer.

The effect of change in air flow rate through the instrument for given tritium concentrations is shown in Fig. 9. It will be noted that the change in Sniffer reading amounts to about 20% with a change in air flow rate from 0.3 cubic meter per minute to 0.15 cubic meter per minute. The collection of lint and dirt on the ion chamber screen is the principal cause of a diminished air flow rate and it is important that the screen be kept clean.

Figures 10 and 11 show the average calibration curves for five different Sniffers, both battery and AC operated, on the 4 and 5 scales. It is interesting to note that the 4 scale does not appear to be a true decade function of the 5 scale. Calibrations were not made on scales 2 and 3. Values obtained on scales 2 and 3 would be far in excess of the air tolerance figure and, as a rule, would not be used in routine monitoring procedures. For practical purposes, it might be convenient to assume that these scales are decade functions of scale 4.

All the calibrations were based upon an average relative humidity value of 30%. It was of interest to increase the relative humidity to 70 and 75% and perform the same calibrations. The increase in humidity was accomplished by converting the drying tower ahead of the mixing chamber into a humidifier. No significant difference in Sniffer readings was seen for a given tritium concentration at the increased humidity.

A 90-volt ion trap was inserted ahead of the ion chamber of the Sniffer and calibrations were performed. The ion trap collected a large percentage (greater than 90%) of the ionization produced by the tritium before reaching the Sniffer. As a consequence, the sensitivity of the Sniffer is decreased as it then responds only to the ionization which the tritium produces in its short transit time through the ion chamber. The calibration curve is given in Fig. 12.

Figure 13 shows a calibration curve for tritium as 100% HTO and as a gaseous mixture

of 60% HT and 40% HTO. It seemed apparent that the response of the instrument was the same for tritium existing in both states.

CONCLUSIONS

The practical use of these instruments in the field has shown some characteristics which are not apparent from the foregoing discussion. Although a knowledge of the "equilibrium time" is important, in actual use it is not apparent; that is, a glass tritium system has been observed to crack, releasing tritium and the instrument rings instantaneously. Subsequent experiments showed that ringing occurred very quickly even when the instrument was 30 ft away from the source.

We attribute this behavior to two things: first, that tritium gas diffuses very rapidly through the atmosphere, and second, in such cases more than the tolerance amount was released. Thus, although the equilibrium conditions were not established, there was still a sufficient number of ions for the instrument to respond.

It should be emphasized that these instruments are primarily warning devices and that the operator must be aware of the limitations. In operation it is very simple to check the sensitivity inasmuch as the ionization from a match will set off the alarm on scale 3. This feature has led to speculation as to its value as a fire alarm. However, no comparisons with conventional methods have been made.

Abundant experience has shown that these instruments are valuable as detectors. Since they are relatively simple and cheap to build, they can be put to use in large numbers. They can be serviced by personnel with a small amount of training, and experience has shown that they are reliable in operation.

REFERENCES

1. J. A. Fleming, "Terrestrial Magnetism and Electricity," 1st ed., p. 242 (McGraw-Hill Book Company, Inc., New York, 1939).
2. W. C. Elmore and M. Sands, "Electronic Techniques," 1st ed., p. 186 (McGraw-Hill Book Company, Inc., New York, 1949).
3. J. McClelland and M. F. Milligan, Los Alamos Scientific Laboratory Report LA-1645 (1954).
4. T. F. Malone, Ed., "Compendium of Meteorology," pp. 120-127 (Waverly Press, Baltimore, Md., 1951).

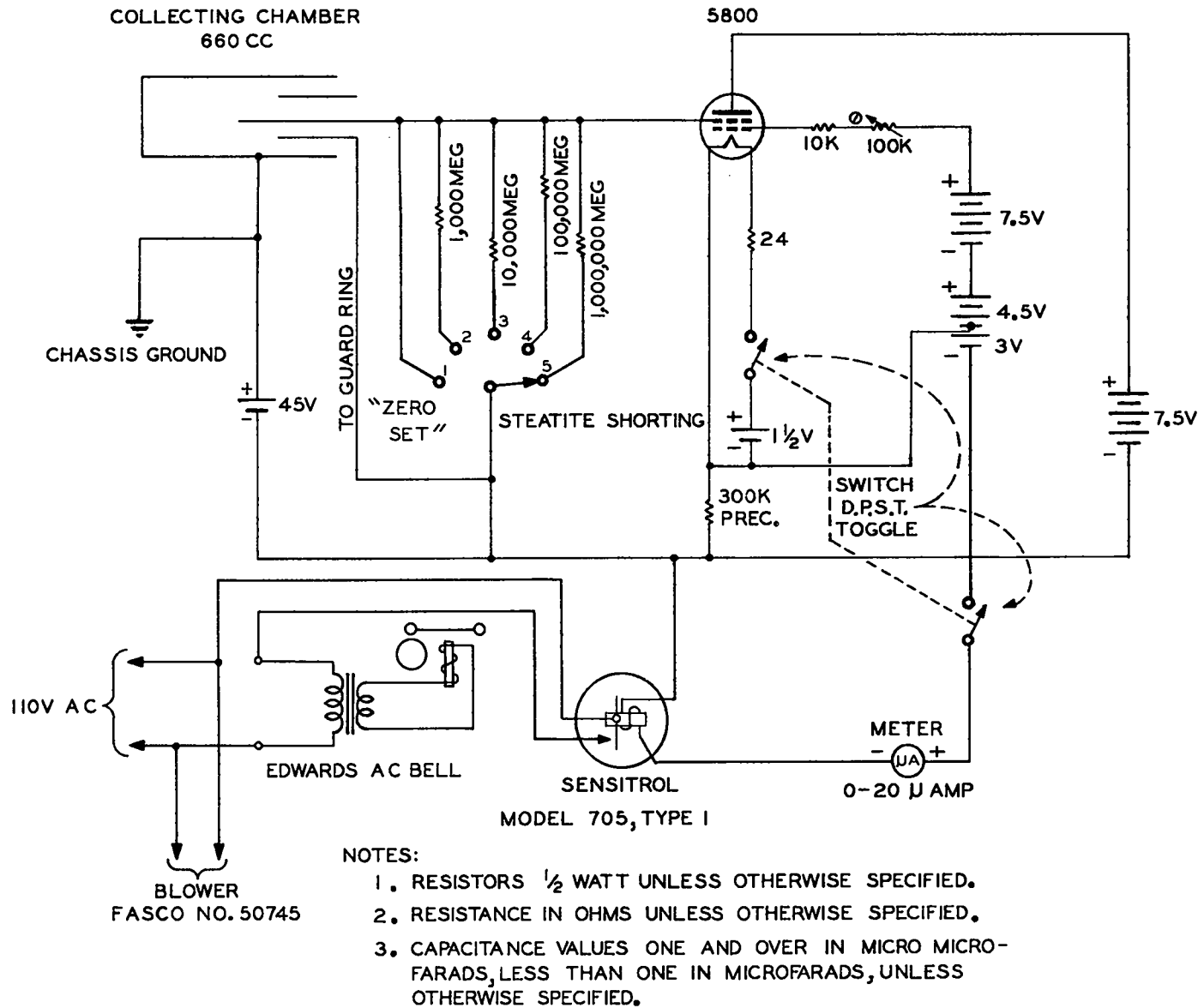

Fig. 1. Circuit of the air conductivity meter.



Fig. 2. A portable air conductivity meter.

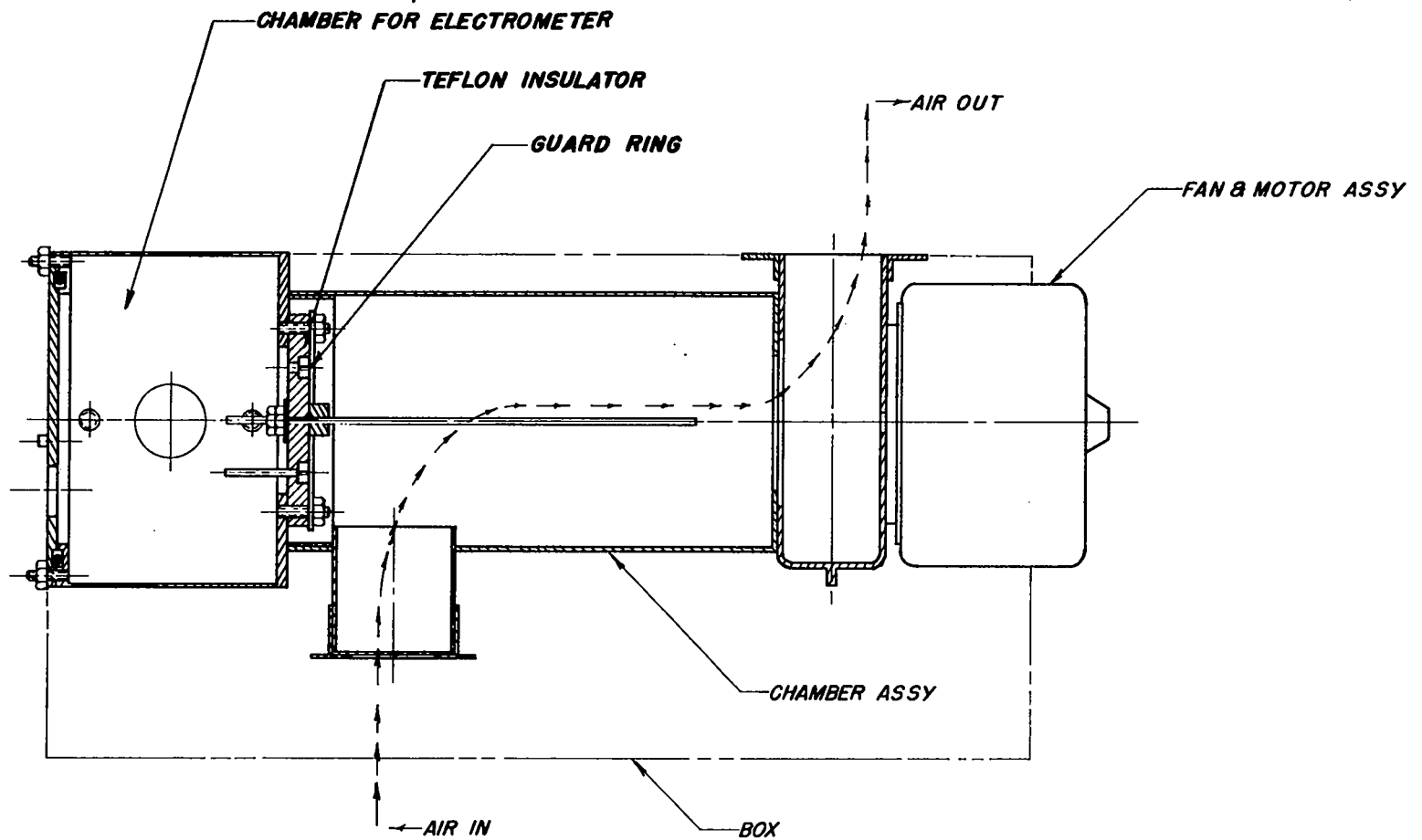
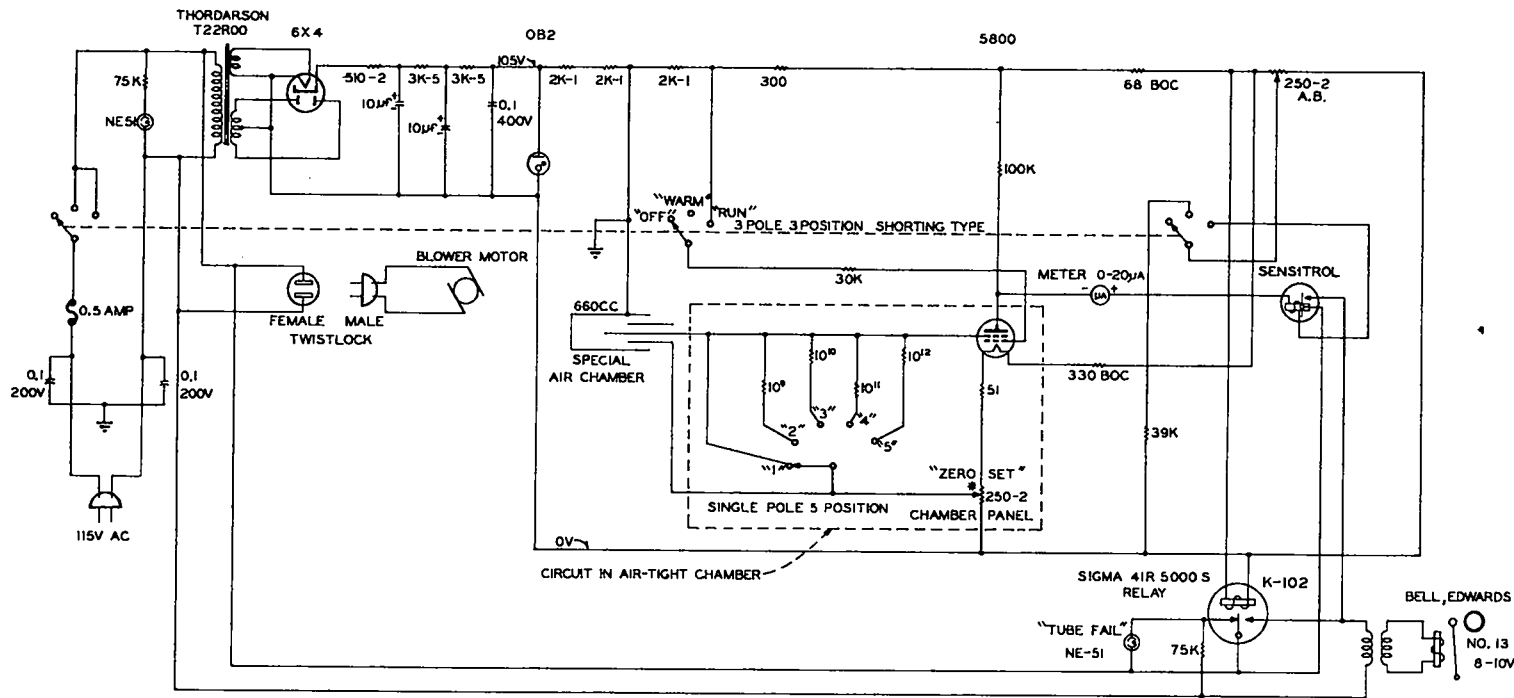
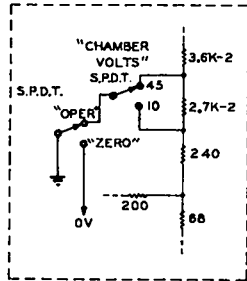

Fig. 3. Cross section of the ion chamber arrangement.



- NOTES:
1. ALL RESISTORS ARE 1/2 WATT UNLESS OTHERWISE SPECIFIED.
 2. RESISTANCE IN OHMS UNLESS OTHERWISE SPECIFIED.
 3. CAPACITANCE VALUES ONE AND OVER IN MICRO MICROFARADS, LESS THAN ONE IN MICROFARADS, UNLESS OTHERWISE SPECIFIED.
 4. * DENOTES MOST CLOCKWISE POSITION.

Fig. 4. Schematic of the Model 110 AC Operated Air Conductivity Meter.



CHAMBER POTENTIAL SELECTION IN STATION NO. 1

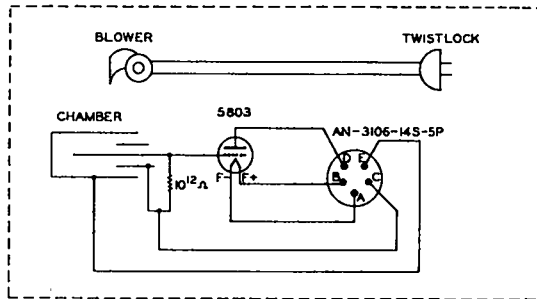

REMOTE UNIT (ONE OF SIX STATIONS)

NOTES:

1. ALL RESISTORS 1/2 WATT UNLESS OTHERWISE SPECIFIED.
2. RESISTANCE IN OHMS UNLESS OTHERWISE SPECIFIED.
3. CAPACITANCE VALUES ONE AND OVER IN MICRO MICRO-FARADS, LESS THAN ONE IN MICROFARADS, UNLESS OTHERWISE SPECIFIED.

- 12 -

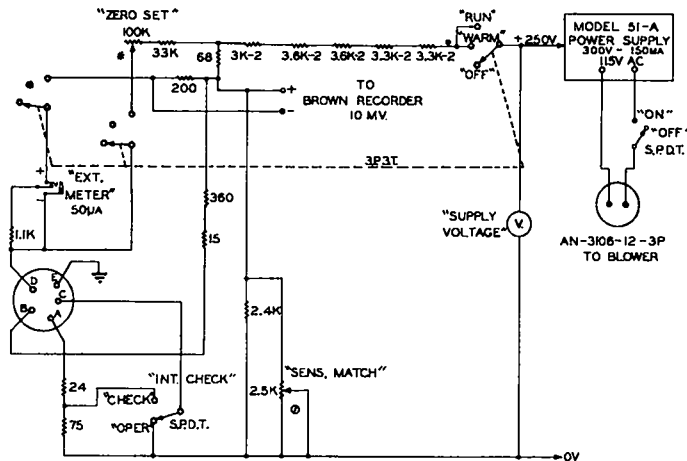

POWER AND CONTROL (ONE OF SIX STATIONS)

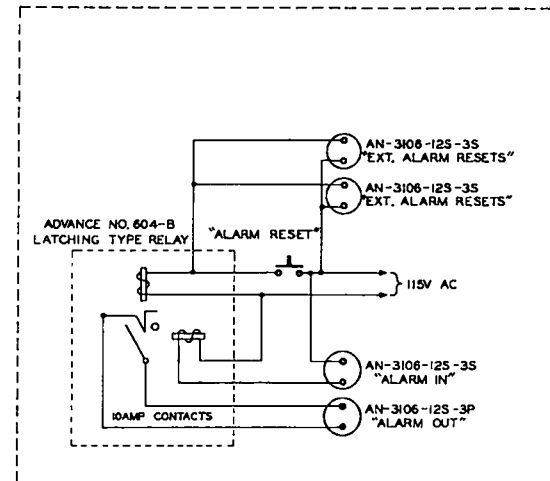

ALARM CIRCUIT

Fig. 5. Circuit of a Multi-Station Logarithmic Meter.

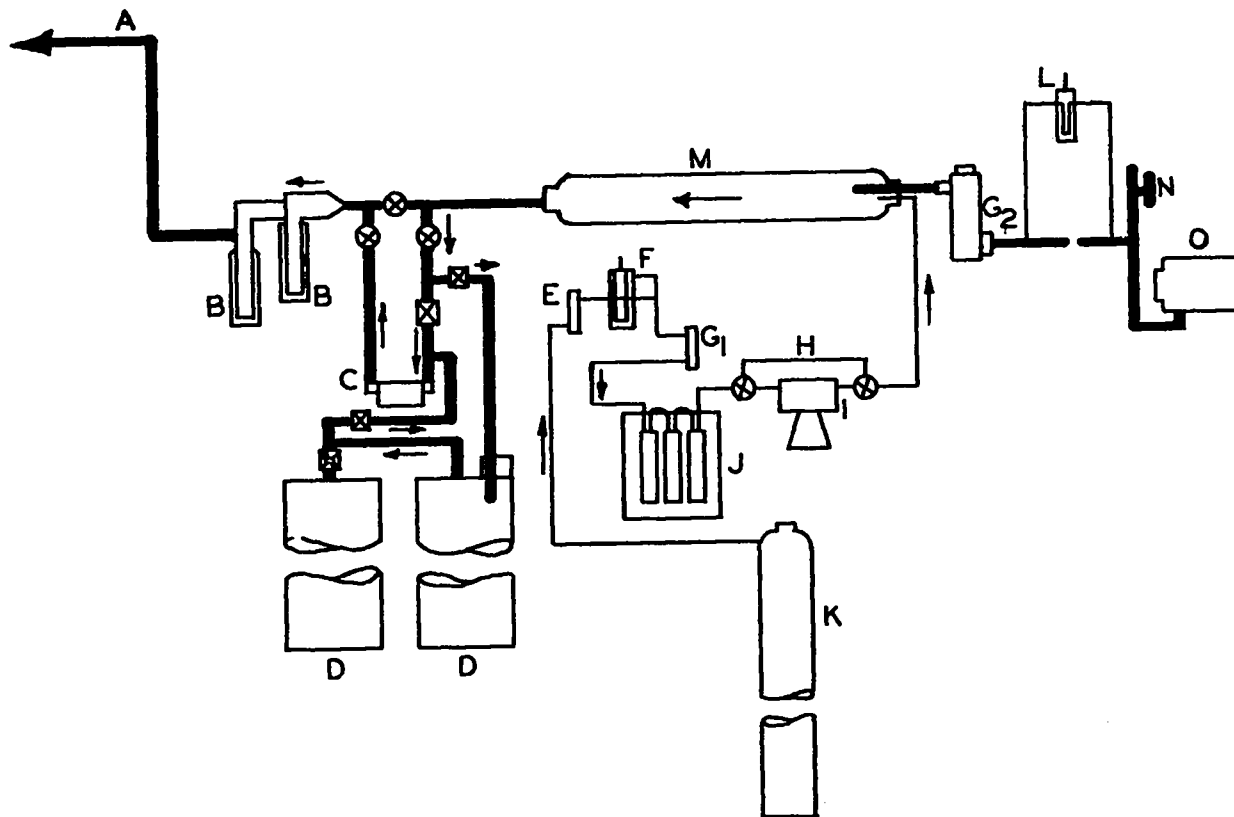

A EXHAUST DUCT
B LIQUID AIR TRAPS
C TRITIUM MONITORING DEVICE
D 55 GAL. DRUMS .4M³ VOLUME
E ROTAMETER
F BACK PRESSURE GAUGE
G₁-G₂ DRYING TOWERS
H BY-PASS

I ZINC FURNACE
J BUBBLERS IN CONSTANT TEMPERATURE BATH
K NITROGEN SIZE D CYLINDER
L ORIFICE METER
M MIXING CHAMBER .01M³ VOLUME
N BLEEDER VALVE
O SUTOR-BILT PUMP

Fig. 6. Schematic drawing of the calibration equipment.

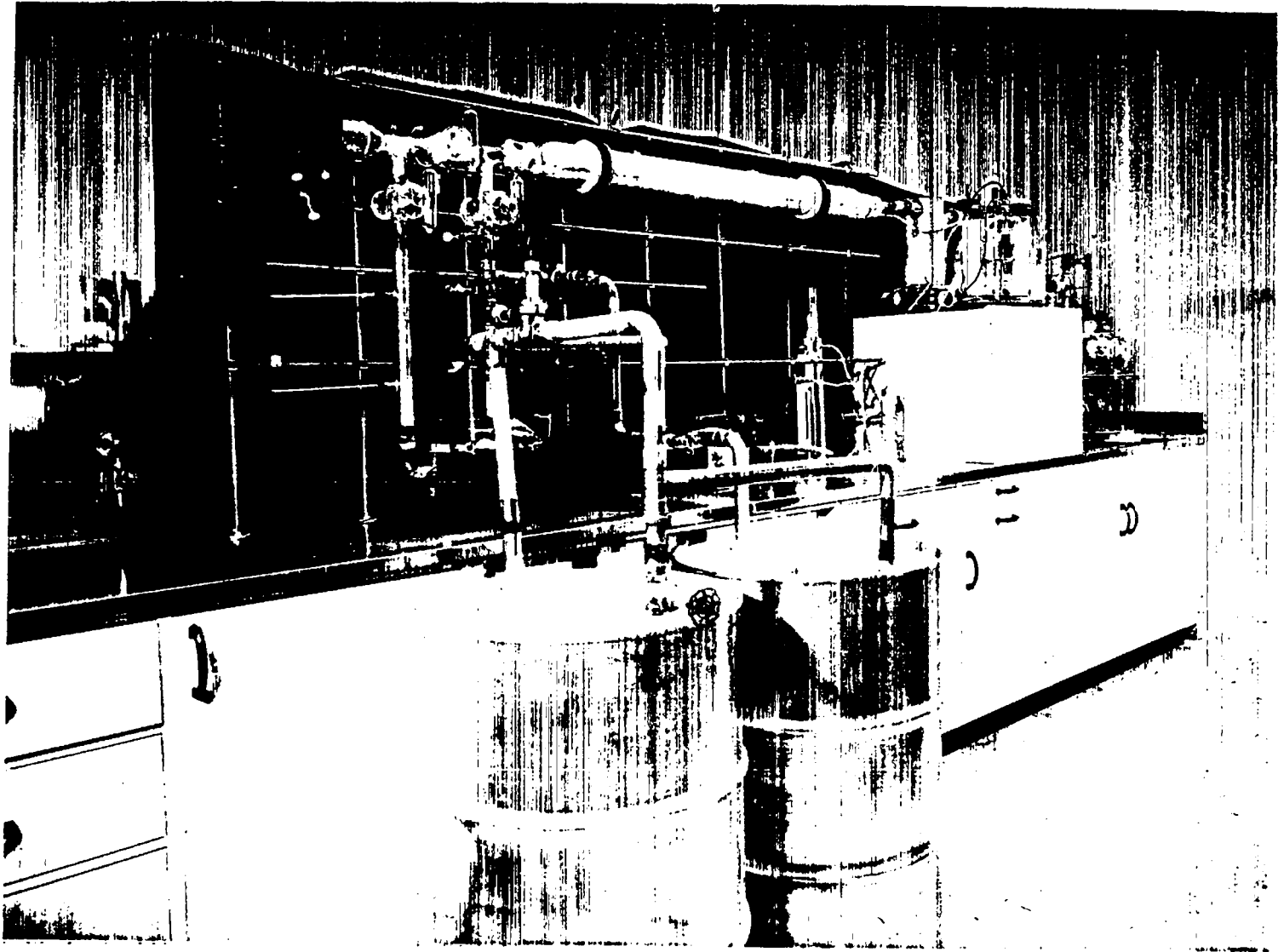

Fig. 7. Photograph of the calibration equipment.

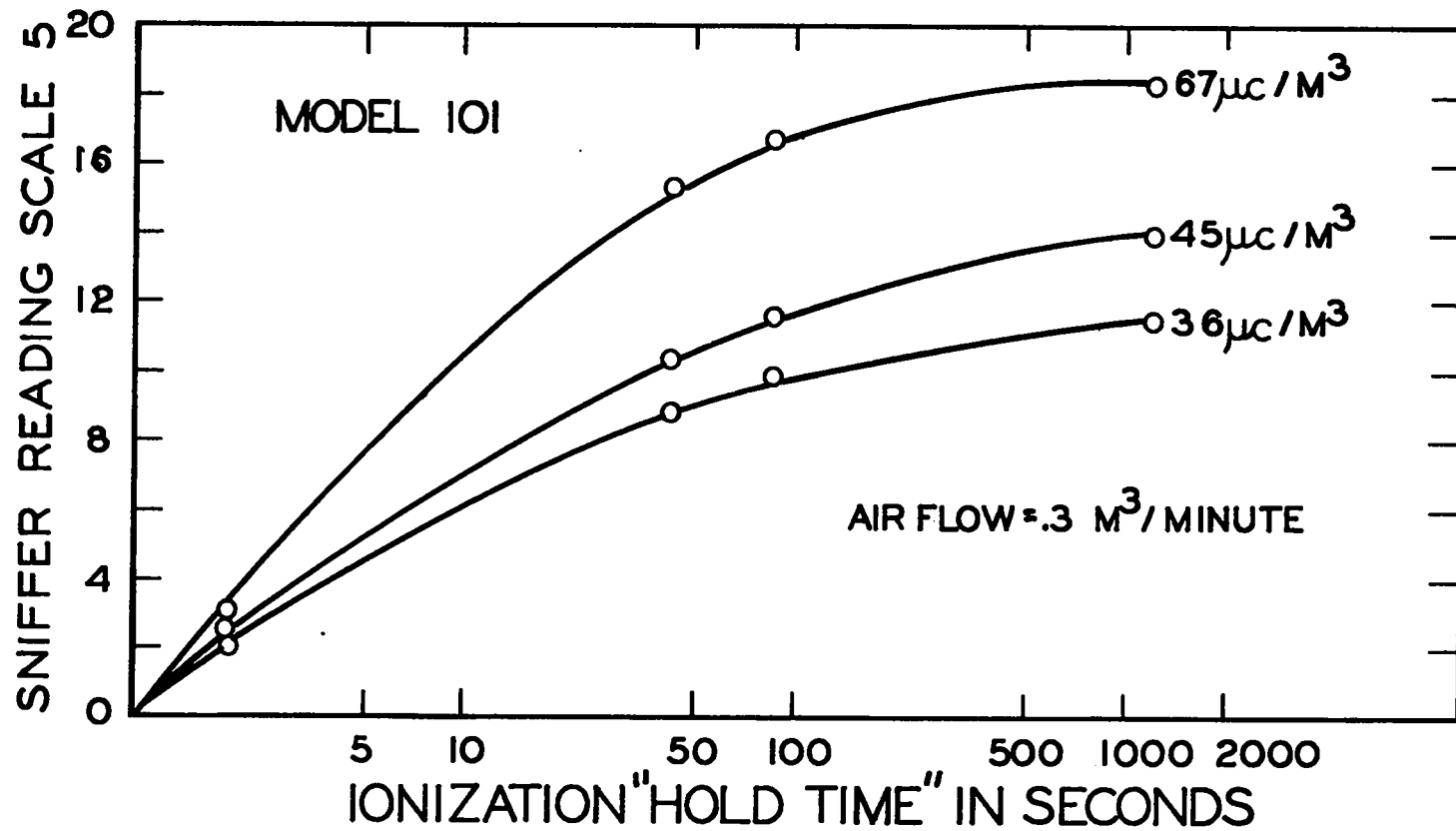

Fig. 8. Meter reading for given concentration of tritium as a function of "hold time" in seconds.

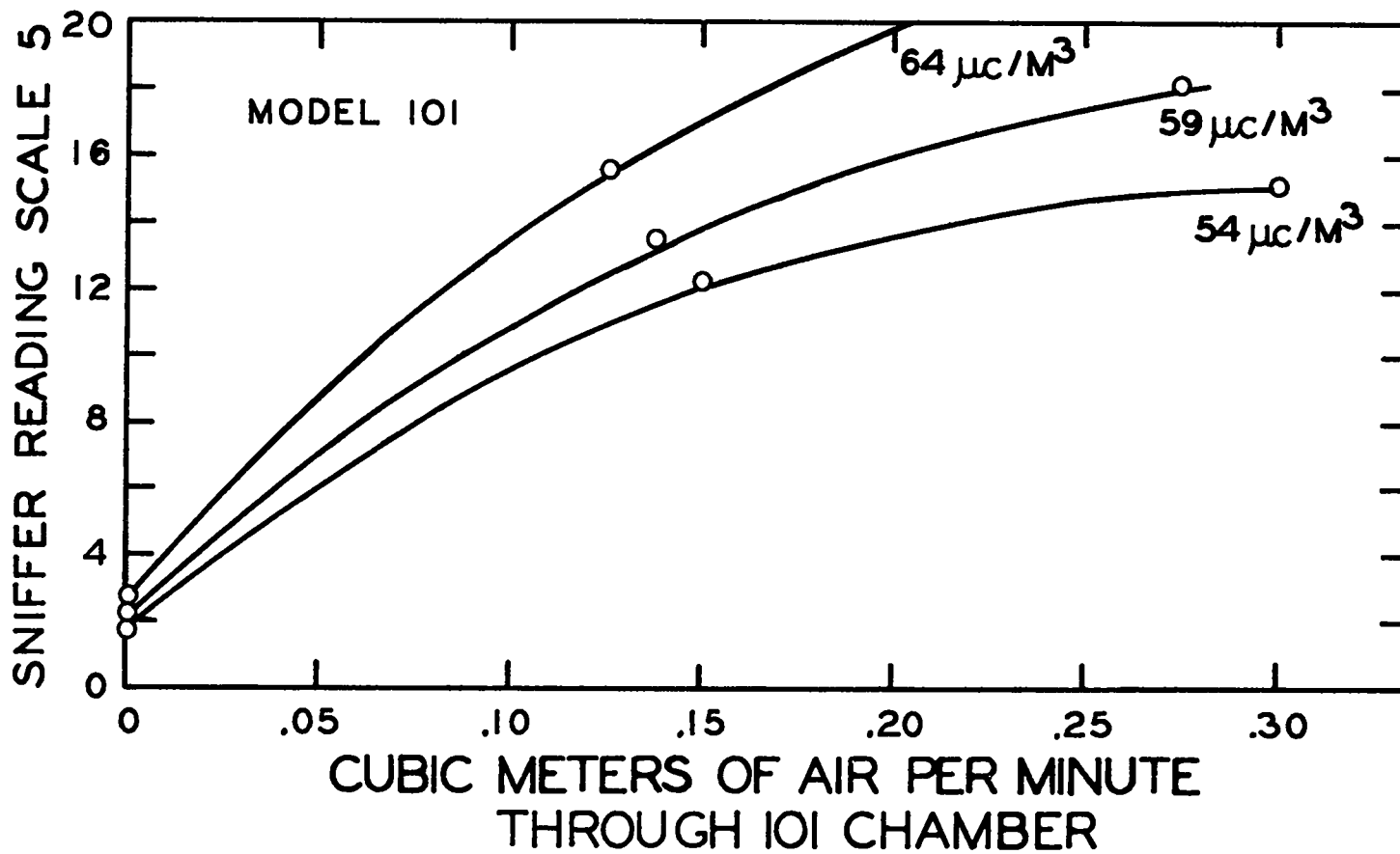

Fig. 9. Effect of air flow rate for a given tritium concentration.

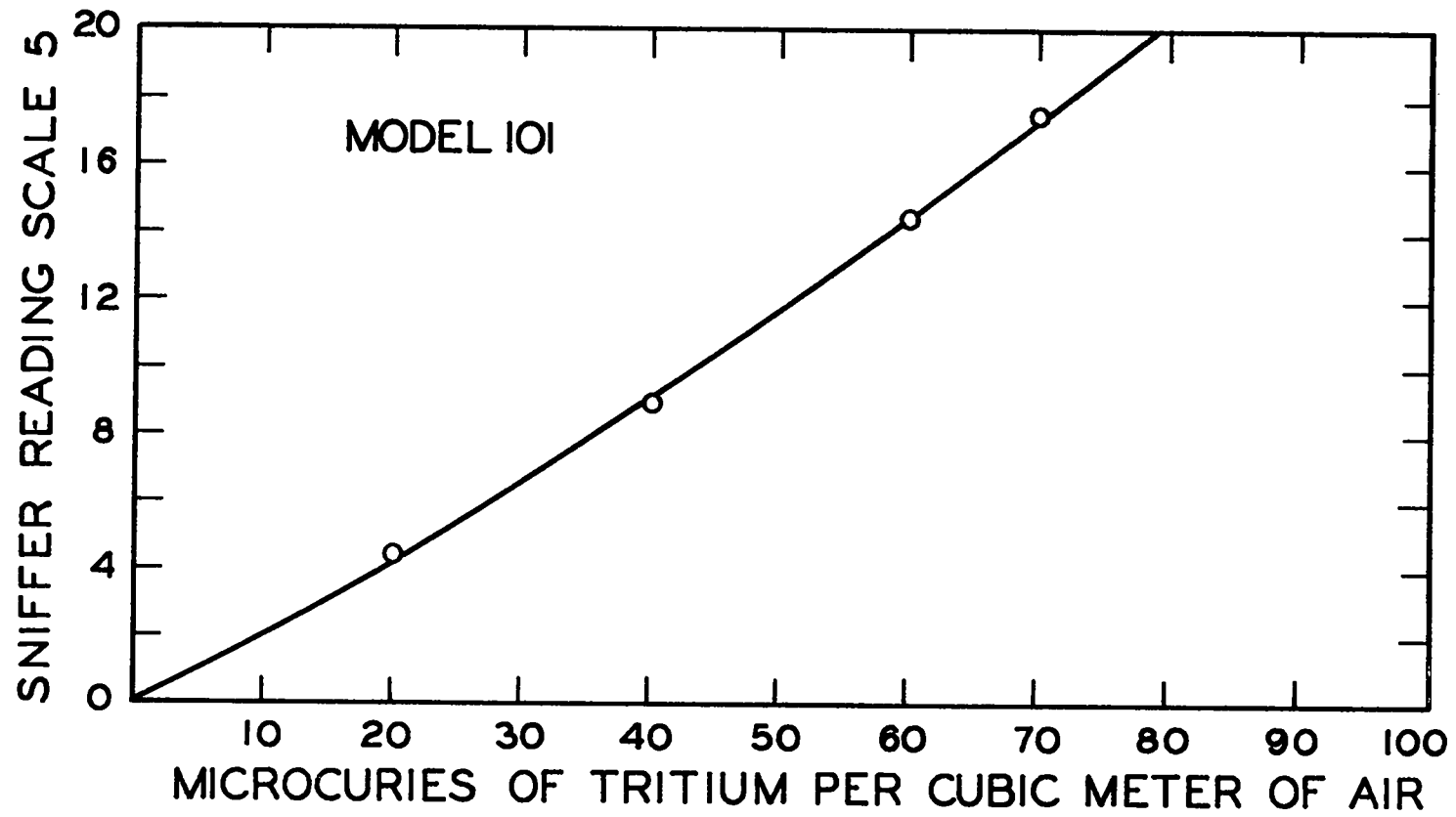

Fig. 10. Average calibration curves for five instruments on the most sensitive scale.

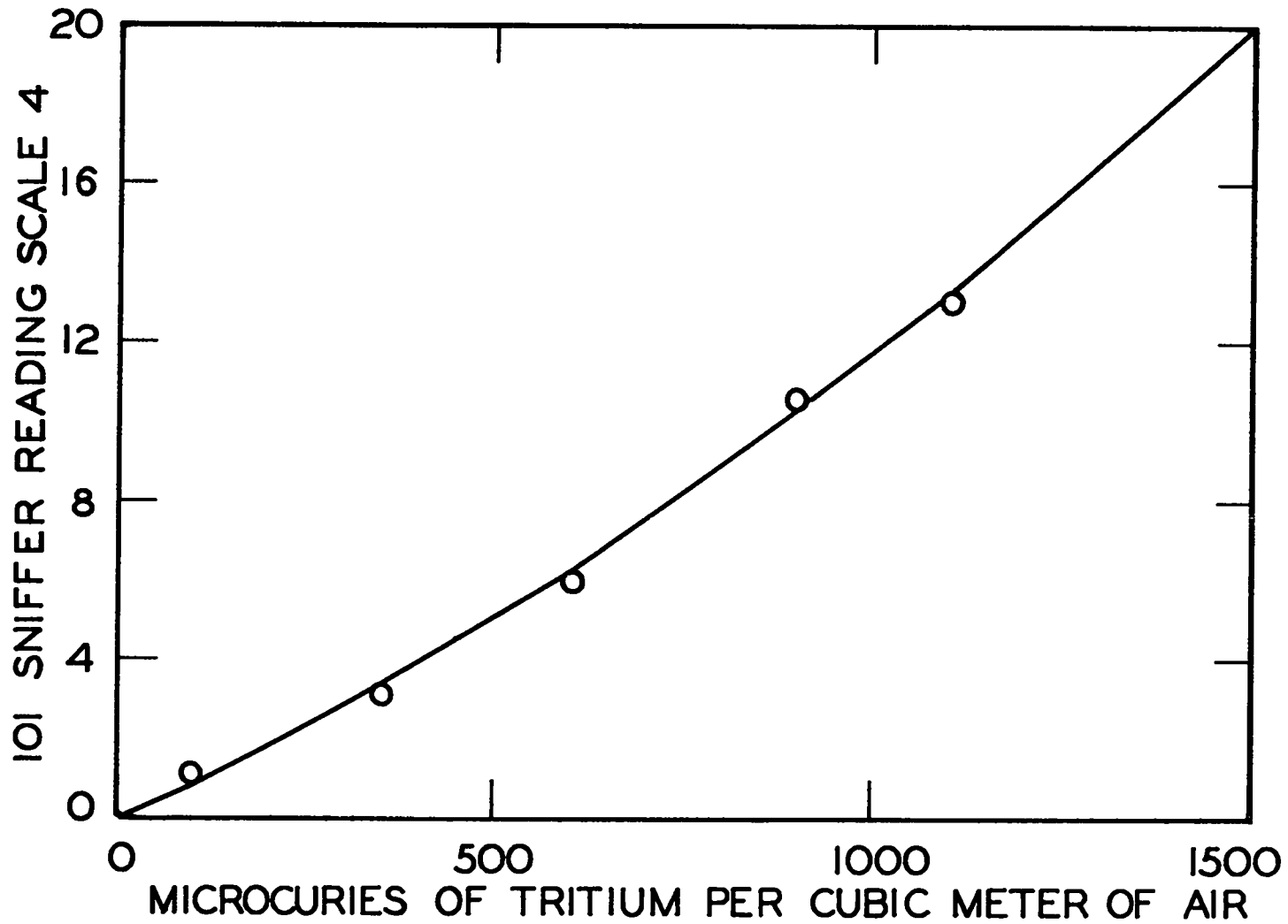

Fig. 11. Average calibration curves for five instruments on a less sensitive scale.

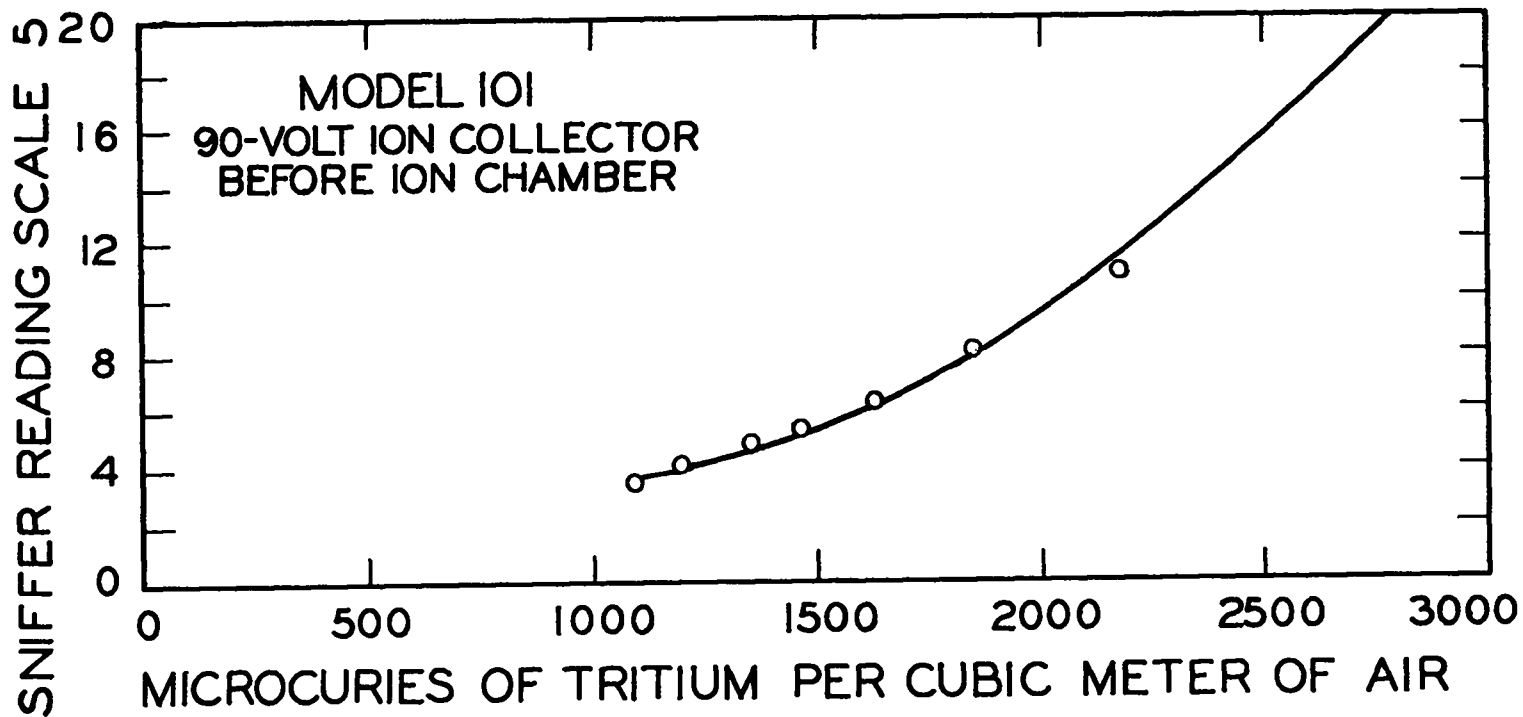

Fig. 12. Calibration of an instrument with a 90-volt ion trap before the ionization chamber.

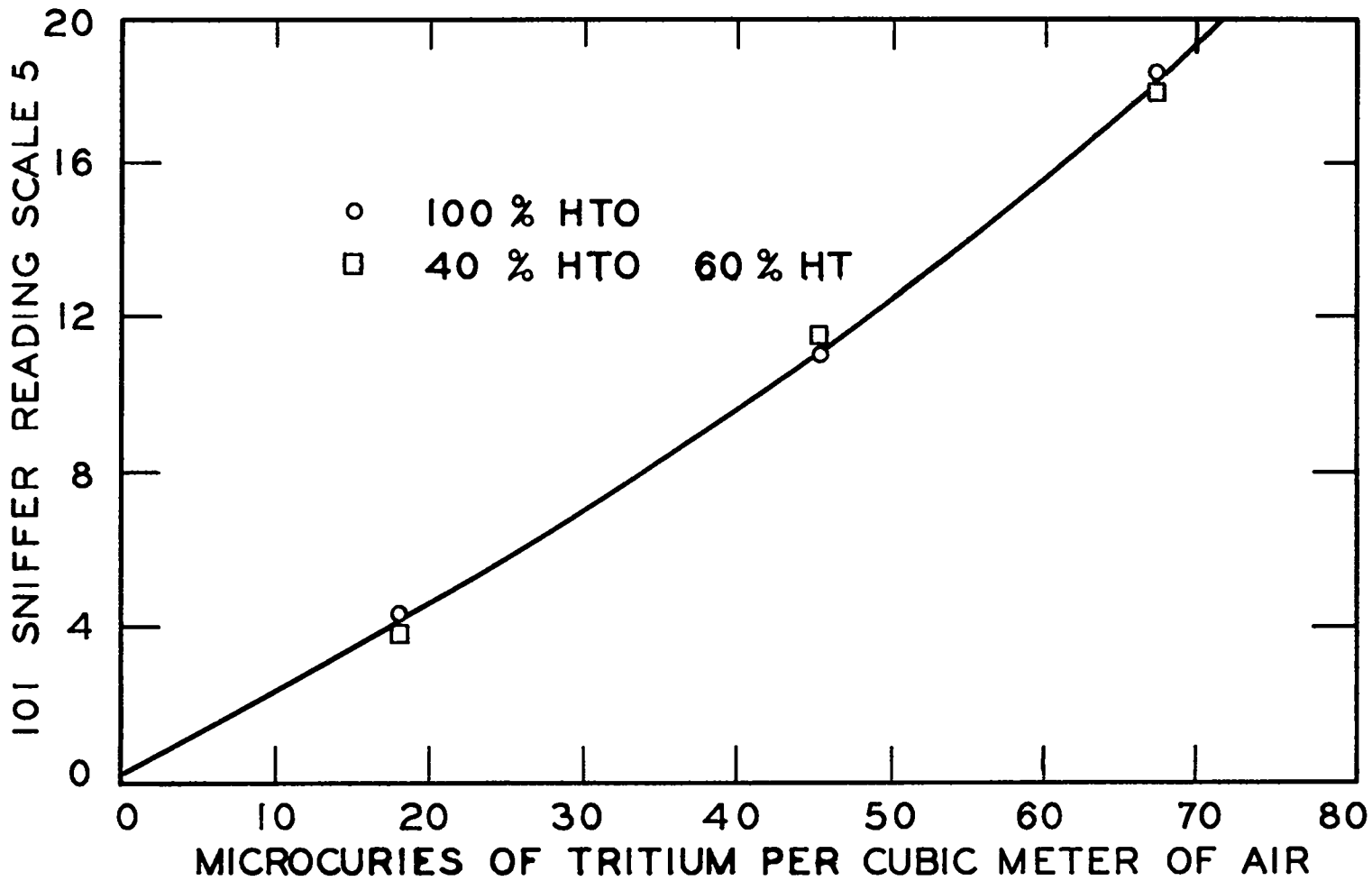

Fig. 13. Calibration curve for tritium as 100% HTO and as a gaseous mixture of 60% HT and 40% HTO.