

Conf-740406--9

**TITLE: DEMOLITION OF BUILDING 12, AN OLD PLUTONIUM FILTER FACILITY**

**AUTHOR(S): E. L. Christensen, R. Garde, and A. M. Valentine**

**SUBMITTED TO: 2nd AEC ENVIRONMENTAL PROTECTION CONFERENCE,  
ALBUQUERQUE, NEW MEXICO, APRIL 16-19, 1974**

By acceptance of this article for publication, the publisher recognizes the Government's (license) rights in any copyright and the Government and its authorized representatives have unrestricted right to reproduce in whole or in part said article under any copyright secured by the publisher.

The Los Alamos Scientific Laboratory requests that the publisher identify this article as work performed under the auspices of the U. S. Atomic Energy Commission.

  
**Los Alamos  
Scientific Laboratory**  
of the University of California  
LOS ALAMOS, NEW MEXICO 87544

**NOTICE**  
This report was prepared as an account of work sponsored by the United States Government. Neither the United States nor the United States Atomic Energy Commission, nor any of their employees, nor any of their contractors, subcontractors, or their employees, makes any warranty, express or implied, or assumes any legal liability or responsibility for the accuracy, completeness or usefulness of any information, apparatus, product or process disclosed, or represents that its use would not infringe privately owned rights.

**MASTER**

DISTRIBUTION STATEMENT IS UNLIMITED

fe9

# DEMOLITION OF BUILDING 12, AN OLD PLUTONIUM FILTER FACILITY

## ABSTRACT

This report discusses the decommissioning and disposal of a plutonium contaminated filter facility at Los Alamos, along with the health physics, waste management, and environmental aspects of the demolition. The filter system had provided ventilation for the main plutonium processing plant at Los Alamos from 1945 until 1973.

by

E. L. Christensen, R. Garde, and A. M. Valentine

of

The Los Alamos Scientific Laboratory \*

P. O. Box 1663

Los Alamos, New Mexico

\* Work done under the Auspices of the U. S. Atomic Energy Commission

April 8, 1974

## Table of Contents

<u>Title</u>	<u>Page No.</u>
1. History . . . . .	1
2. Description of Facility . . . . .	2
3. Decontamination of Facility . . . . .	11
4. Demolition of Facility . . . . .	12
5. Health Physics . . . . .	49
6. Waste Management . . . . .	54
7. Environmental Air Monitoring . . . . .	56
8. Soil Sampling . . . . .	62
9. Final Site Condition . . . . .	63
10. List of Figures . . . . .	70
11. List of Tables . . . . .	73

## **1. History**

**A plutonium processing facility was built in 1944 on what is now known as DP Mesa in Los Alamos. The urgency of that period of time dictated that the facility be built as rapidly as possible and yet incorporate all of the best construction ideas available for such facilities but using those materials that were readily available.**

**The process buildings were of sheet metal construction on a 1.22 metres high concrete wainscoting. Plaster on metal lath over metal studs was used to give a smooth interior surface.**

**Ventilation of the buildings was accomplished with a central air exhaust system with a capacity of 60,000 m<sup>3</sup>/min. This system was to handle air from rooms and fume hoods, sparging of dissolvers and venting of solution tanks. At that time it was not believed necessary to exhaust air from the glove boxes. It was several years before the decision was made to exhaust air from these work enclosures and when they were ventilated the air was exhausted, without being filtered, through the room air exhaust system. Particulates were to be removed from the exhaust air by the use of electrostatic precipitron units backed up by a single bank of American Air Filter Company Type PL-24 filters. This system was judged to be the best available for clean-up of air at that time.**

**The filter building was completed and placed in service during May, 1945. It continued in service for both room and process air until July 1, 1959. In 1959 another filtration system was completed for the process air and only room air was handled in Building 12 after that date. Building 12 continued in service until February, 1973 when new room air filtration systems were completed, one for each of the process buildings.**

## **2. Description of Facility**

**The site plan in Fig. 1 shows the relationship of the process buildings to the filter building. The air from the rooms was exhausted at floor level, up vertical ducts through the roof, then in ducts mounted parallel to the roof, to the collector duct built on the peak of the roof. The finished site is shown in Fig. 2. The filter building, designated as Building 12, can be seen on the left. The ductwork was constructed of galvanized steel. Corrosion began immediately in the ductwork for those rooms where chemical fumes were generated, and small holes were created within a few years. Corrosion products along with dirt drawn through the holes in the ductwork were all deposited in the plenum of Building 12.**

**The floor plan of Building 12 is shown in Fig. 3 with the legend being listed in Table 1. The floor area was 30.8 metres by 19.5 metres for that portion housing the filters and precipitron units. The intake**

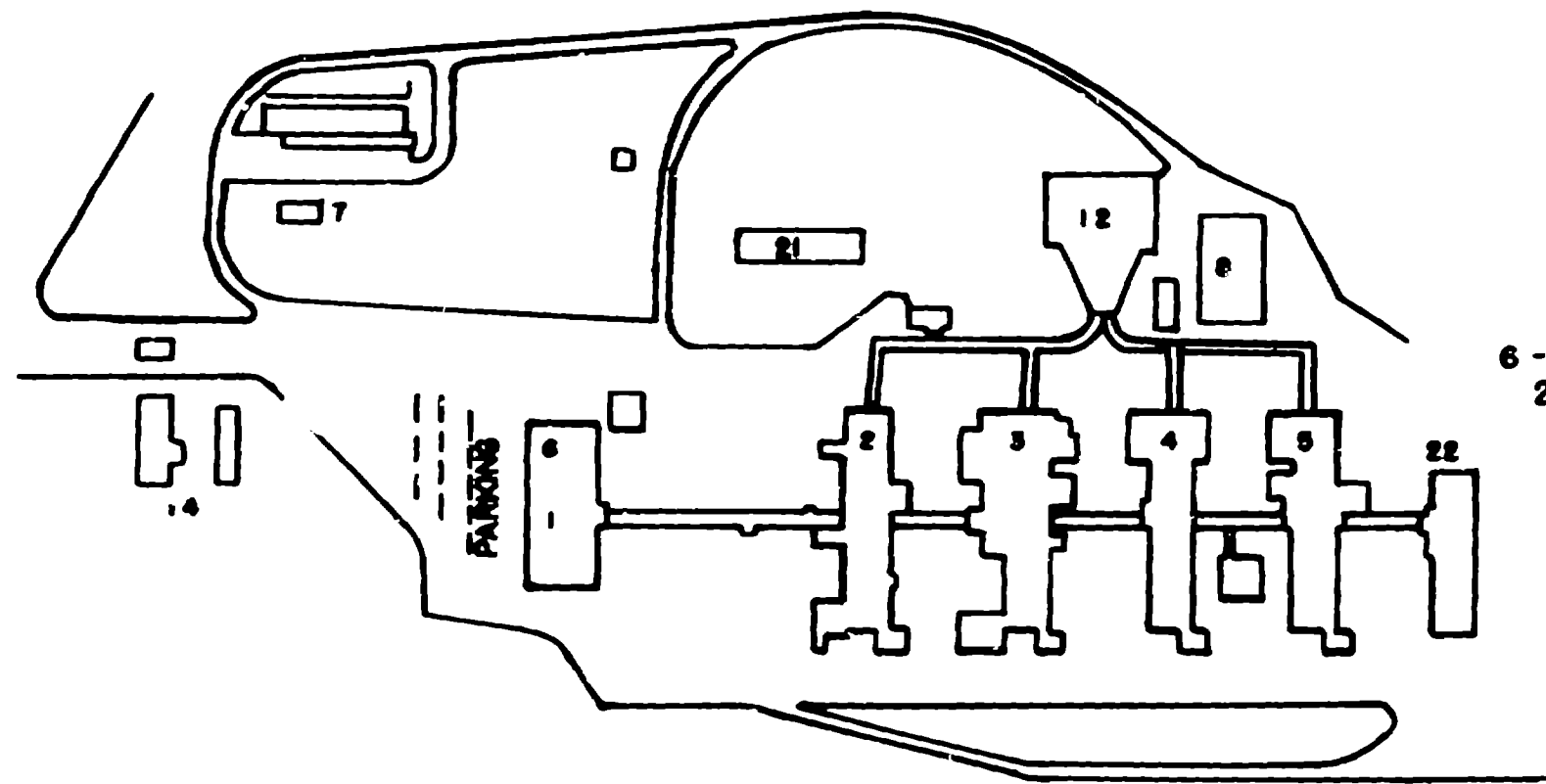

BUILDINGS

- 1. OFFICES & CHANGE ROOMS
- 2. ETHER EXTRACTION
- 3. OXALATE PRECIPITATION
- 4. FLUORINATION OF OXALATE
- 5. METAL PREPARATION & FABRICATION
- 6-21. PLANT SERVICES
- 22. RESEARCH & DEVELOPMENT

Fig. 1. GENERAL LAYOUT OF DP SITE WEST

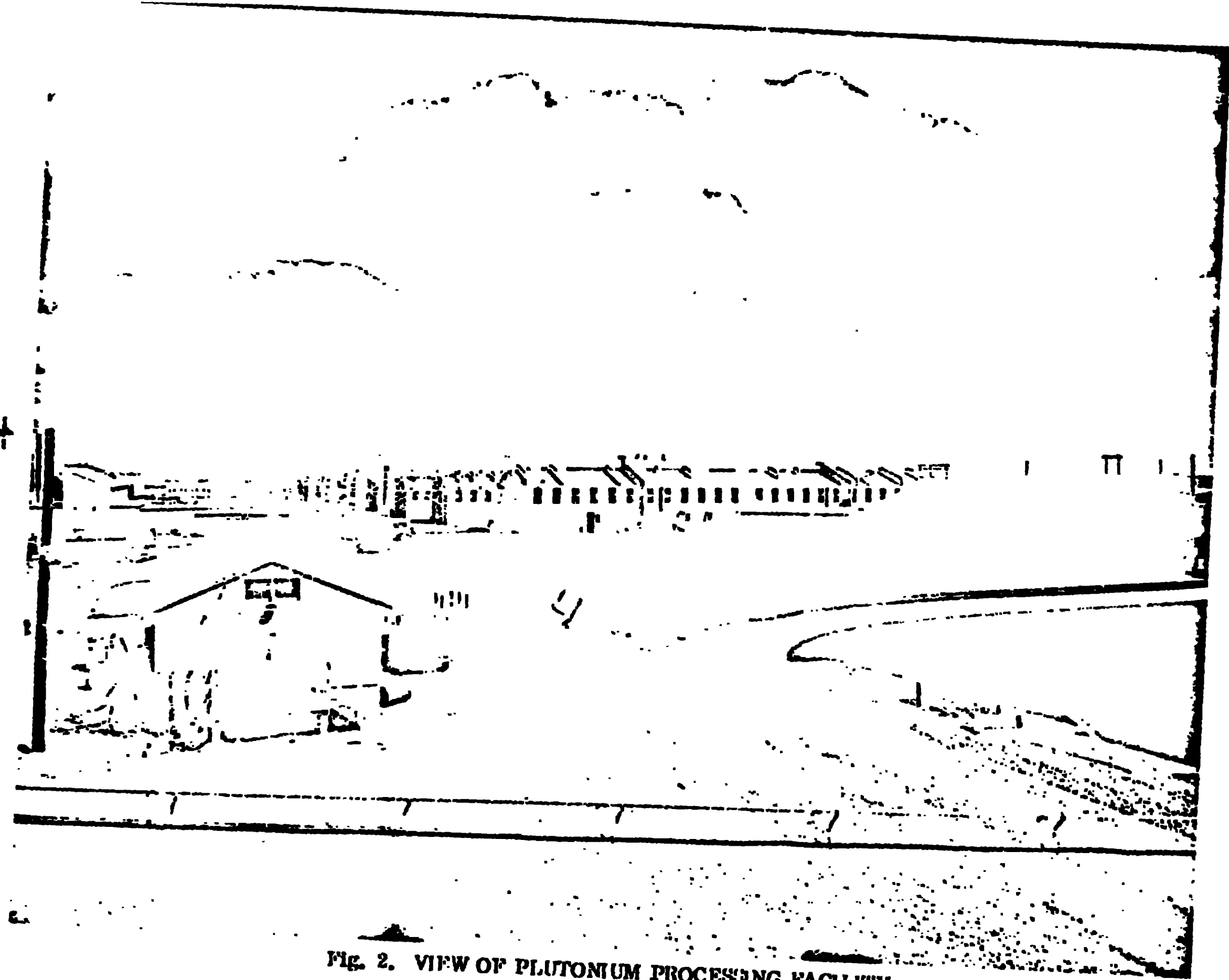

FIG. 2. VIEW OF PLUTONIUM PROCESSING FACILITY

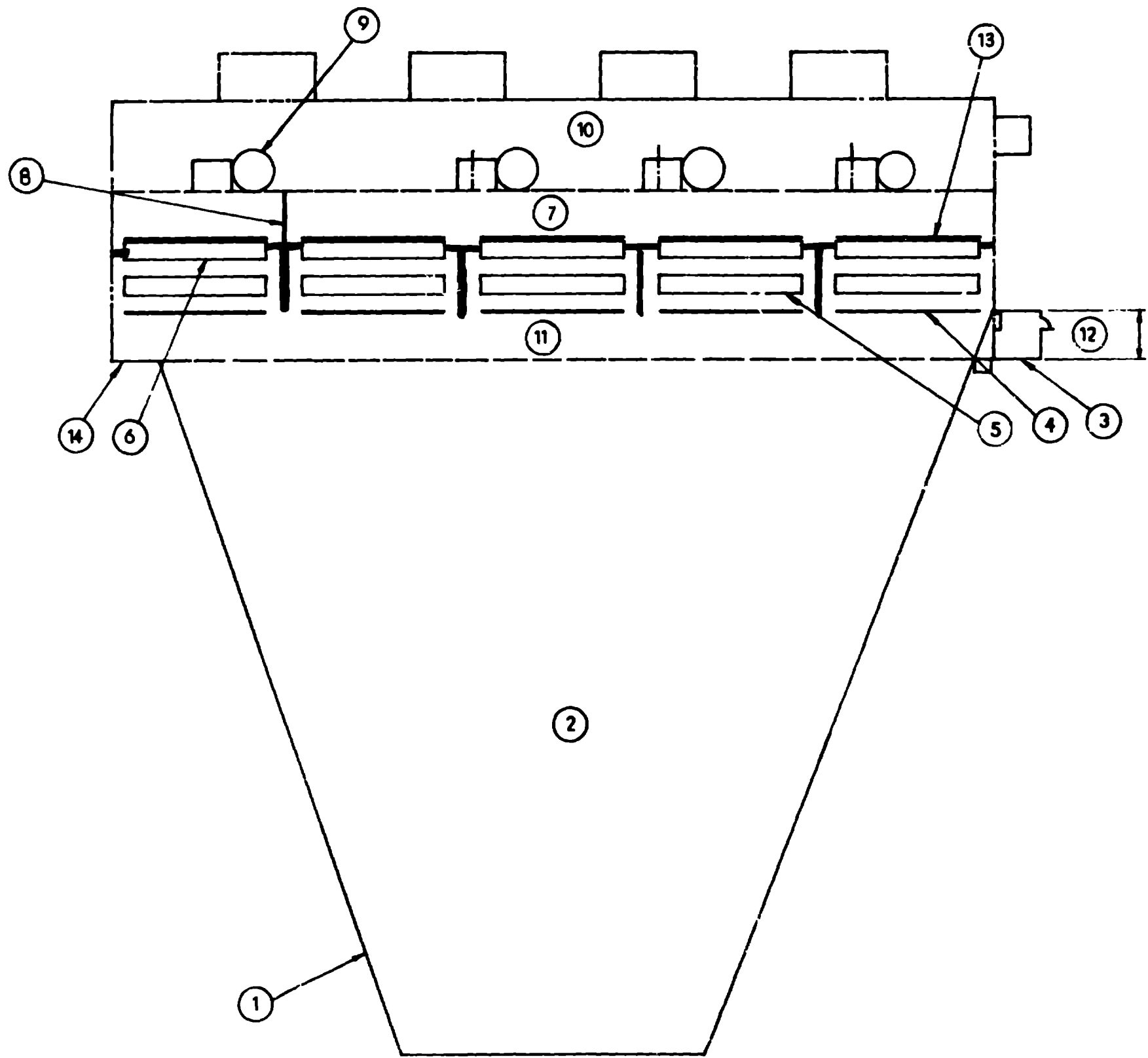

Fig. 3. PLAN- BUILDING DP-12



**Table 1**

**Legend for Fig. 3**

- 1. Transition Plenum Opening**
- 2. Transition Plenum Area**
- 3. Temporary Change Room**
- 4. South Filter Isolation Doors**
- 5. Electrostatic Precipitron Framing**
- 6. Filters and Filter Framing**
- 7. Exhaust Blower Plenum Area**
- 8. New Temporary Wall**
- 9. Operative Exhaust Fan and Stack**
- 10. Blower Room Area**
- 11. Area of Plastered Ceiling**
- 12. Penthouse Area above Structure**
- 13. Plenum Isolation Doors**
- 14. Existing Brick Walls**

plenum was a trapezoidal area measuring 23.5 metres wide at its longest base, 7.6 metres wide where the air entered the building and 18.9 metres from that point to the rectangular portion of the building.

The precipitron units and filter banks were built in 5 sections with a wall between each section. Each section had two large doors that could be lowered to isolate a section while filters were being changed or while work was being done on the precipitron unit in that section. Access to the isolated section was by way of ladders from the second story section of the building. This second story also housed the doors when they were in the raised position.

A side view of the building is shown in Fig. 4 and a side view of the filter and blower area, Fig. 5, shows the position of the electrostatic precipitron units, the PL-24 filter bank, the common blower plenum, the exhaust blowers, and the doors used to isolate each of the filter sections. A front view of the building is shown in Fig. 6.

The method of construction of Building 12 was also dictated by the type of material available at that time. The foundation was concrete but since reinforcing steel was in short supply, it was made deeper and thicker than it would have been if steel had been available. The wall studs and floor and roof beams were wood. These were covered by 2 layers of gypsum board to give a smooth interior surface. This method of construction actually made it easier to prevent the spread of contamination

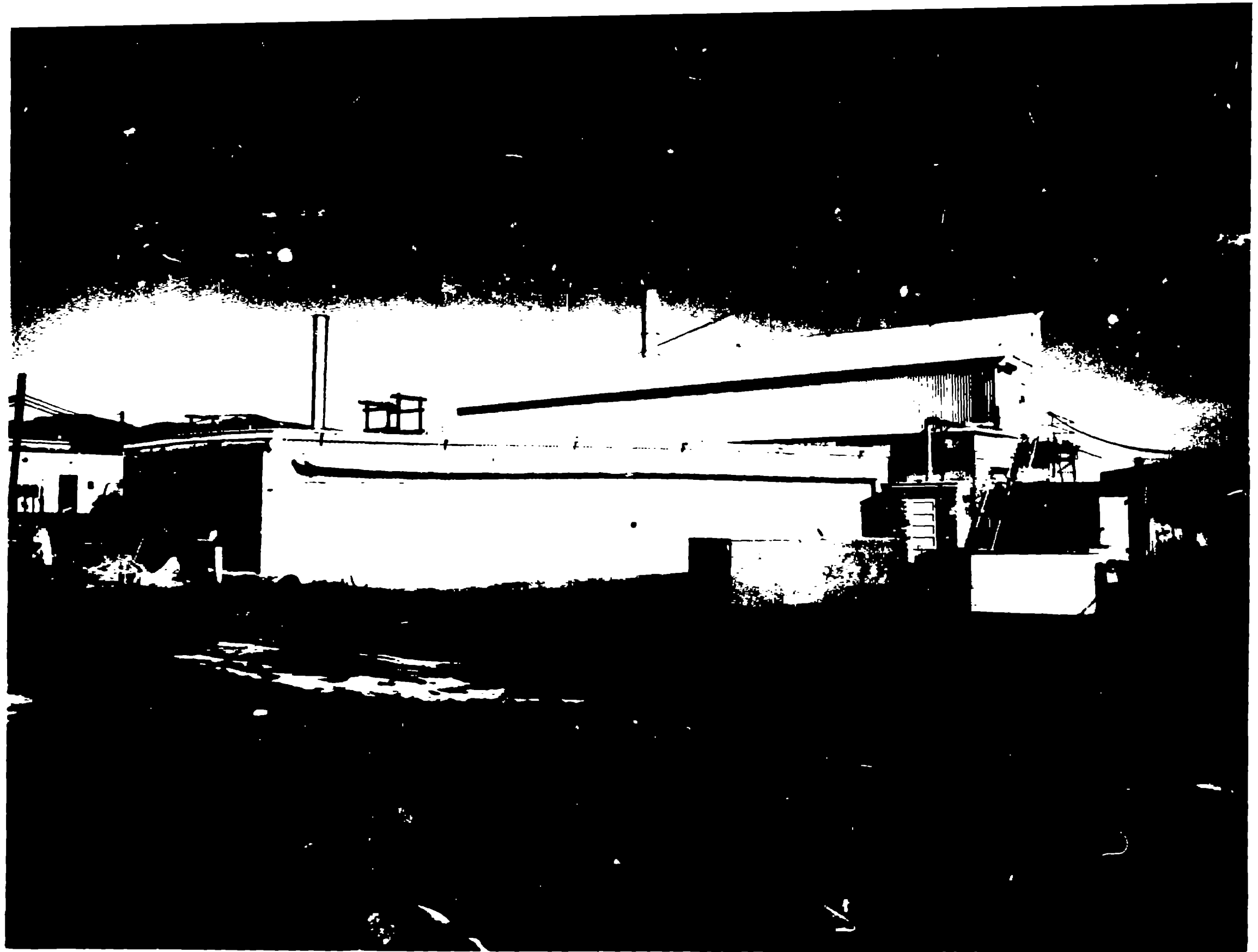

Fig. 4. SIDE VIEW OF BUILDING 12

1. Intake Plenum Isolation Door
2. Blower Plenum Isolation Door
3. Intake Plenum
4. Electrostatic Precipitrons
5. PL-24 Filters
6. Blower Plenum
7. Blowers

-6-

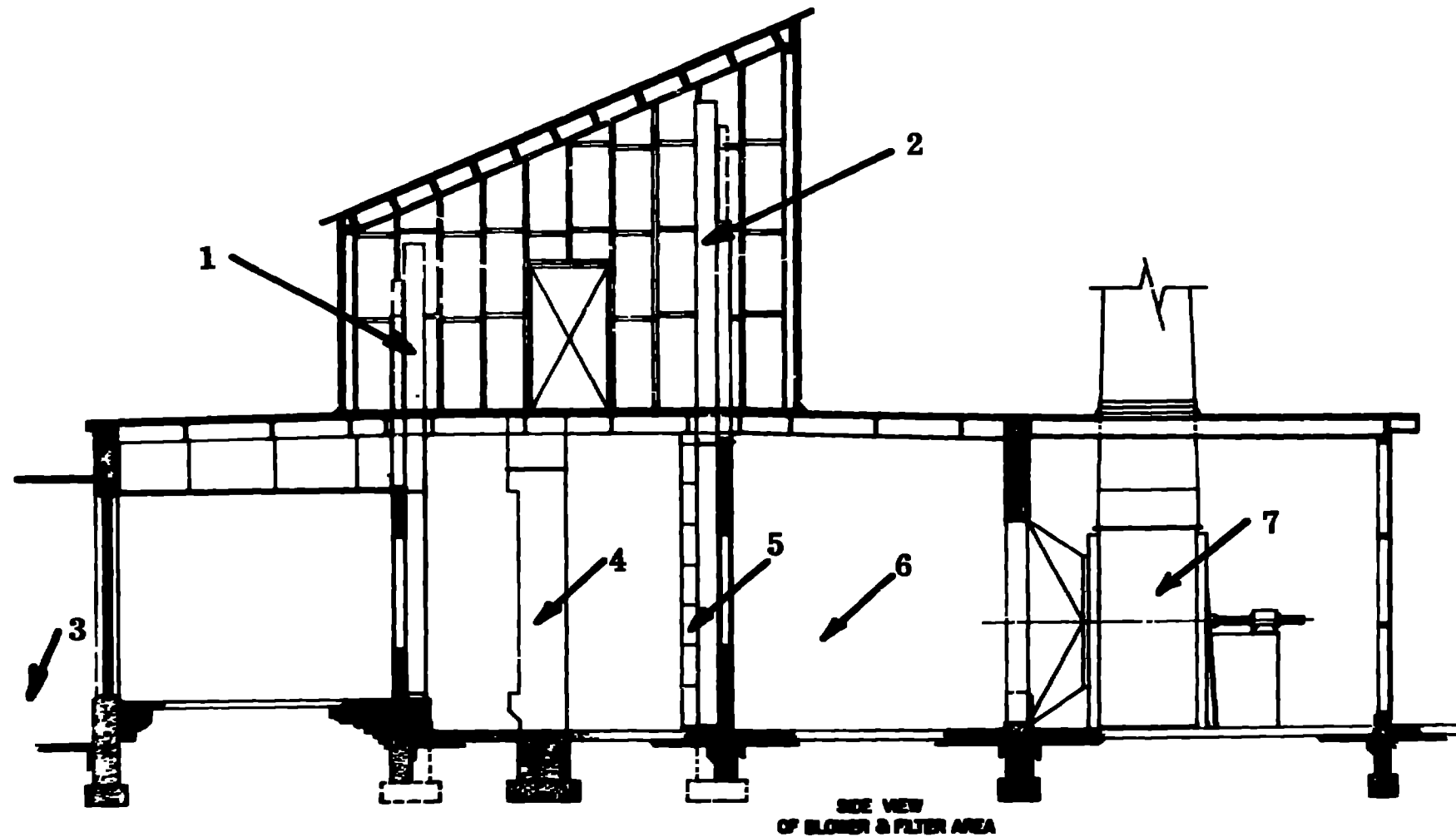

Fig. 5. SIDE VIEW OF BLOWER AND FILTER AREA



Fig. 6. FRONT VIEW OF BUILDING 12

during demolition. The details of construction will be discussed in the section of this report dealing with demolition.

### 3. Decontamination of Facility

In 1960 the interior of the plenum and the largest portion of the air ducts were cleaned. Included in the solids that were removed from the plenum were several hundred pounds of sand that had been used in sandblasting plutonium parts. Samples of the dirt removed from the building in 1960 were analyzed and showed a plutonium content ranging from 0.001 to 0.05 weight percent. About 3,000 kg of dirt were removed from the building during the first cleaning operation. The analytical data indicated that this dirt, which was packed in 2 - 12 mil plastic bags and placed in steel drums for burial, contained about 600 g of plutonium (93.5%  $^{239}\text{Pu}$ , 6%  $^{240}\text{Pu}$ , 0.5%  $^{241}\text{Pu}$ ).

During this initial clean-out the precipitron units were disassembled, removed from the building, wrapped in several layers of plastic and placed in plywood crates for burial.

Over the next few years the building was cleaned several times; each time the final operation was to wipe down the entire floor with wet rags. Immediately after such a cleaning the floor would have a swipe count of only a few hundred d/m but the direct count was still  $> 100,000$  d/m per  $60\text{ cm}^2$ . All of the cracks, such as expansion joints, had a swipe count of  $> 100,000$  d/m.

#### **4. Demolition of Building 12**

**A proposed procedure for the demolition of the building was prepared by a member of the Engineering group and a member of the Plutonium Processing group. This document was submitted to a Demolition Committee for approval. This Committee was composed of representatives from both the Laboratory and the contractor that would do the demolition. The names of the groups represented are shown in Table 2.**

**Demolition work was started using this approved procedure, but as the work progressed, conditions were sometimes encountered which necessitated a change in the procedure. Therefore, this Demolition Committee met every week to hear progress reports on the demolition and to review proposals for any change in the procedure.**

**The first step in the demolition was the removal of the ductwork leading to Building 12. This work was started in 1972 and was completed in February, 1973. As ductwork was removed and air supply reduced, blowers in Building 12 were shut down. When the third blower was shut down a partition was built in the blower plenum so that blower number 4 and filter bank number 5 would provide ventilation for the building during demolition. The position of the partition is shown in Fig. 3 at point number 8.**

**Table 2**

**Departments Represented on Demolition Committee**

**Plutonium Processing**

**Health Physics**

**Environmental Monitoring**

**Fire Safety**

**Industrial Safety**

**Waste Management**

**Engineering Planning**

**Engineering Estimating**

**Transportation**

**Engineering Maintenance**

**Contractor for Demolition**



**In preparation for the cleaning and demolition, a change room was constructed on the east side of the building adjacent to the air lock and access door shown in Fig. 3. The workers were suited up, including a fitting and testing of full face masks, in this change room.**

**The initial cleaning was done by chemical technicians assisted by janitors. The final cleaning just prior to painting was done by janitors and laborers.**

**After the walls, ceilings and partitions had been cleaned with water spray, the floors were wiped with wet rags. Again the contamination could only be reduced to the levels discussed earlier.**

**At that point the application of water-base paint was started using a spray gun. After several applications of paint, nearly all exposed areas in the building no longer had any swipe or direct count. If any paint peeled off the surface the direct count would re-appear and the area had to be wiped with wet rags and re-painted. As expected, all expansion joints still had large amounts of solids that had been deposited by the water soaking down into the joint during previous cleaning operations. The painter was kept on duty during the entire period of demolition and as fresh surfaces were exposed they were immediately coated with water base paint.**

At this stage blowers number 1, 2 and 3 were idle and air was being drawn down the stacks, through the filters in bays 1 through 4 in reverse flow, through the filters in bay 5 in the normal manner and exhausted through blower number 4. With this air flow aiding control of contamination, removal of stacks 1, 2 and 3 was begun. The roof and walls around the blowers for these 3 stacks were removed by lifting on a cable wrapped around ceiling beams. The roof was constructed with the beams terminating at the midpoint of the brick wall separating the blower room from the blower plenum. Thus the beams could be lifted off this dividing wall without exposing the contaminated blower plenum.

After the blower room roof had been removed, except for a section over blower number 4 and another section over the electrical panels, work was started on removal of the stacks. Fig. 7 shows a rigger being lifted to the top of the first 50 foot stack to attach a lifting collar to the stack. The stacks had a square base which was slipped over a slightly smaller male fitting on the blower to provide the air seal. This joint was taped and painted to make it air tight. The stack was removed by cutting the tape, cutting some external supports (which were not contaminated) and lifting the stack off the blower with a crane. The bottom of the stack and the opening of the blower were immediately covered with pre-assembled sheets of plywood. The stack was then placed on a low-boy and the ends sealed with metal plates and wrapped in plastic for hauling to the burial

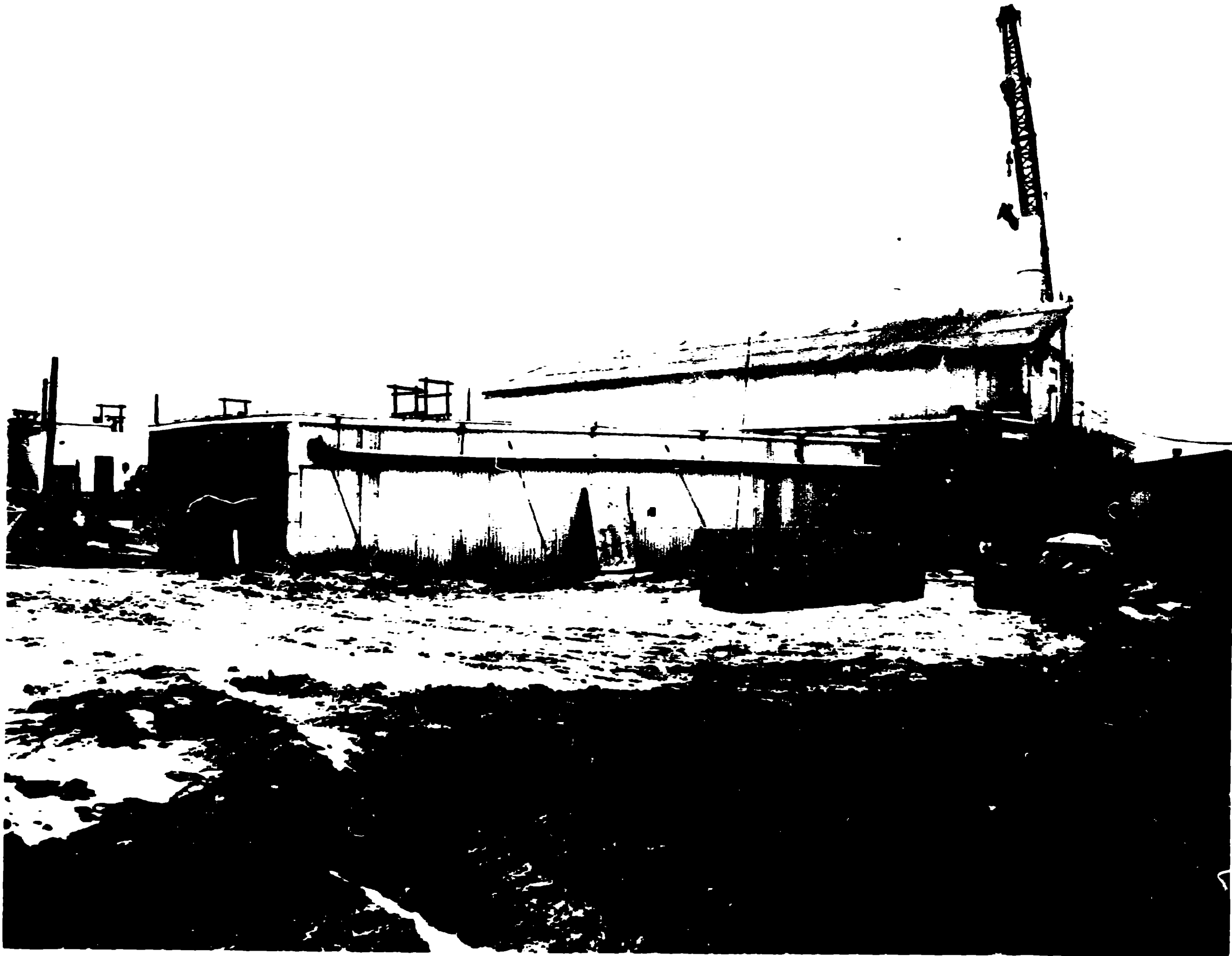

Fig. 7. PREPARING TO REMOVE STACK NUMBER ONE

site. Fig. 8 shows the blower room after the first 3 stacks had been removed.

The next step was to remove all of the filters in banks 1 through 4. As can be seen in Fig. 9, each bank contained 63 filters, each being 0.67 m x 0.67 m x 0.22 m (2' x 2' x 8"). The filters were lifted out of the frame and put into plastic bags, carried to the access door of the change room and slipped into another bag being held by 2 laborers. This outer bag was checked for external contamination so that the package could either be re-bagged or it could be safely carried through the change room to the plywood boxes to be crated for burial.

The filter frames were cleaned and painted before start of disassembly. The filter rack had been made by riveting open-end metal boxes together. The disassembly of the rack required either sawing the frames into pieces or driving a wedge between frames so that the rivets would pop loose. Popping the rivets was found to be the fastest method and thus was used to remove the 252 frames in filter bays 1 through 4. The frames were taken from the building and crated using the same method that was used for the filters.

The laborers then started disassembly of the precipitron frames. These frames were 1.22 metres wide, 0.61 metres deep and 4.27 metres high with a gross weight of 275 kg. As they were unbolted they were lowered to the floor with a chain hoist. They were cleaned, painted and placed on

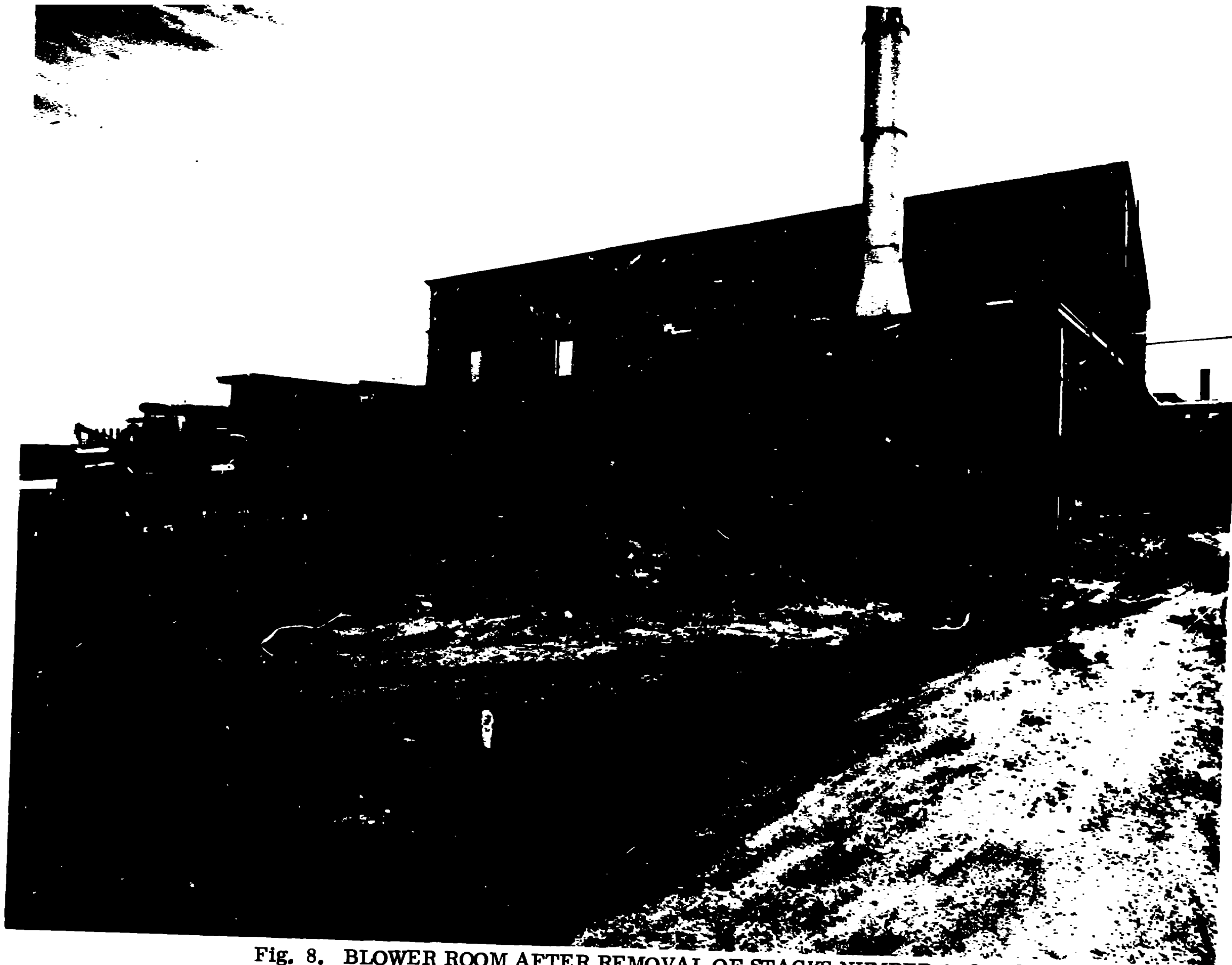

Fig. 8. BLOWER ROOM AFTER REMOVAL OF STACKS NUMBER 1, 2 and 3

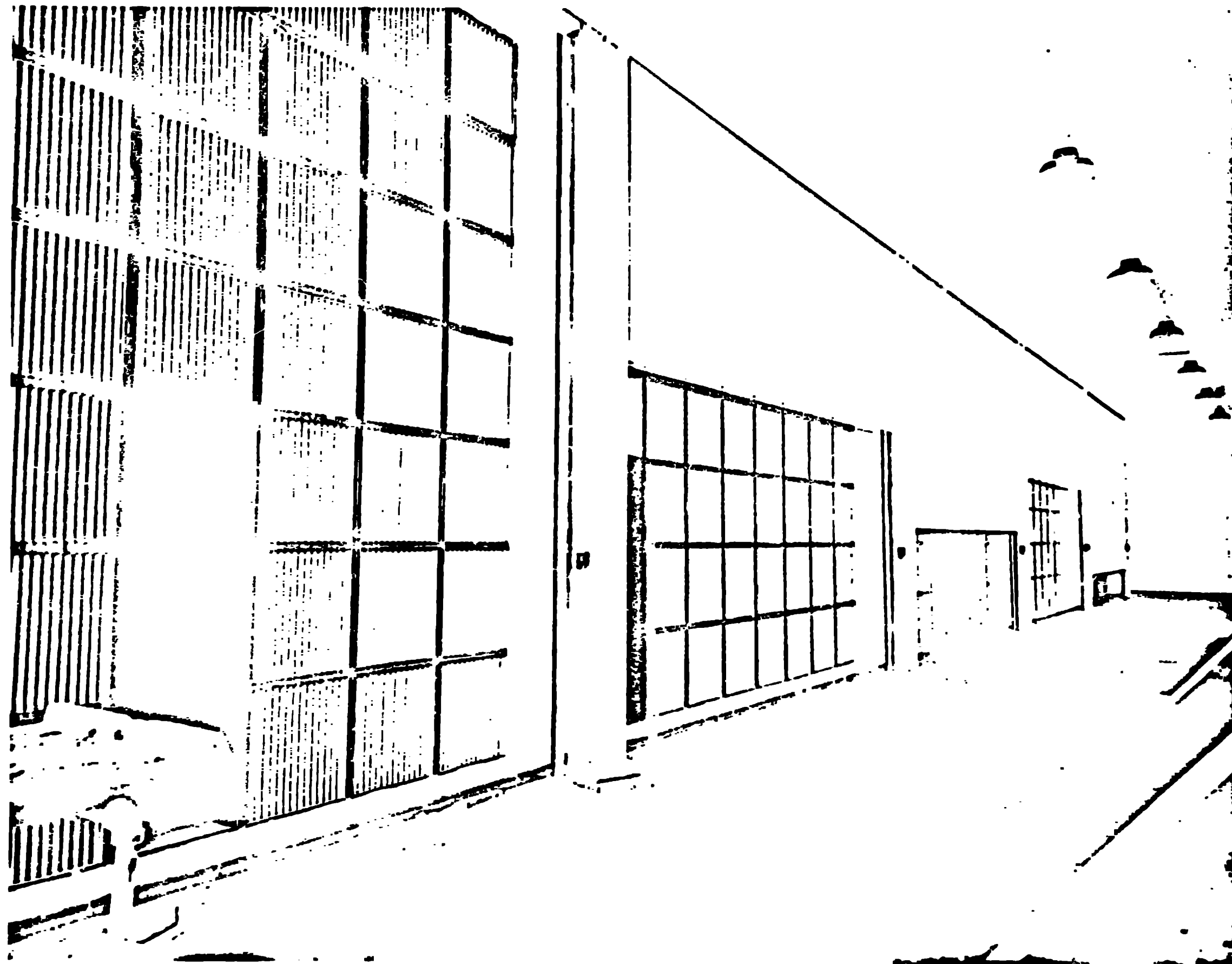

Fig. 9. VIEW OF FILTER BANKS IN 1945

rollers so they could be moved to an access door of the exhaust blower plenum area (See Fig. 3). There a final coat of paint was applied before the frame was rolled through the door onto large plastic sheeting. The frame was wrapped in plastic, loaded on a truck and hauled to the burial site. Figures 10, 11 and 12 give views of various stages of this operation.

Sprinkler pipes, electrical conduit and process lines leading to the oil baths on the precipitron units were removed, cut into 2.5 metre lengths with hacksaws, painted, wrapped in plastic and passed through access doors to be crated for burial.

Similar techniques were used for the large doors used for isolation of a filter section. The doors were constructed of 1.6 cm (5/8 inch) plywood mounted on a 10 cm channel iron frame. Each bay had two doors that were 5.2 metres wide. One door was 3.1 metres high and the other door was 4.3 metres high.

At this point the building was empty, except for the filters in bay 5, and the building was considered ready for removal of the interior surfaces of the walls, floor and ceiling.

The details of construction indicated that the contamination of walls and ceiling might be restricted to the first layer of material. As can be seen in Fig. 13 the roof was made of two layers of wood beams, 5 cm x 20 cm (2 inches by 8 inches), supported by metal I beams. The ceiling was constructed of 2 layers of gypsum board covered by a fabric material called "Walltex". A 1.6 mm thick metal strip was used as a nailing strip to prevent

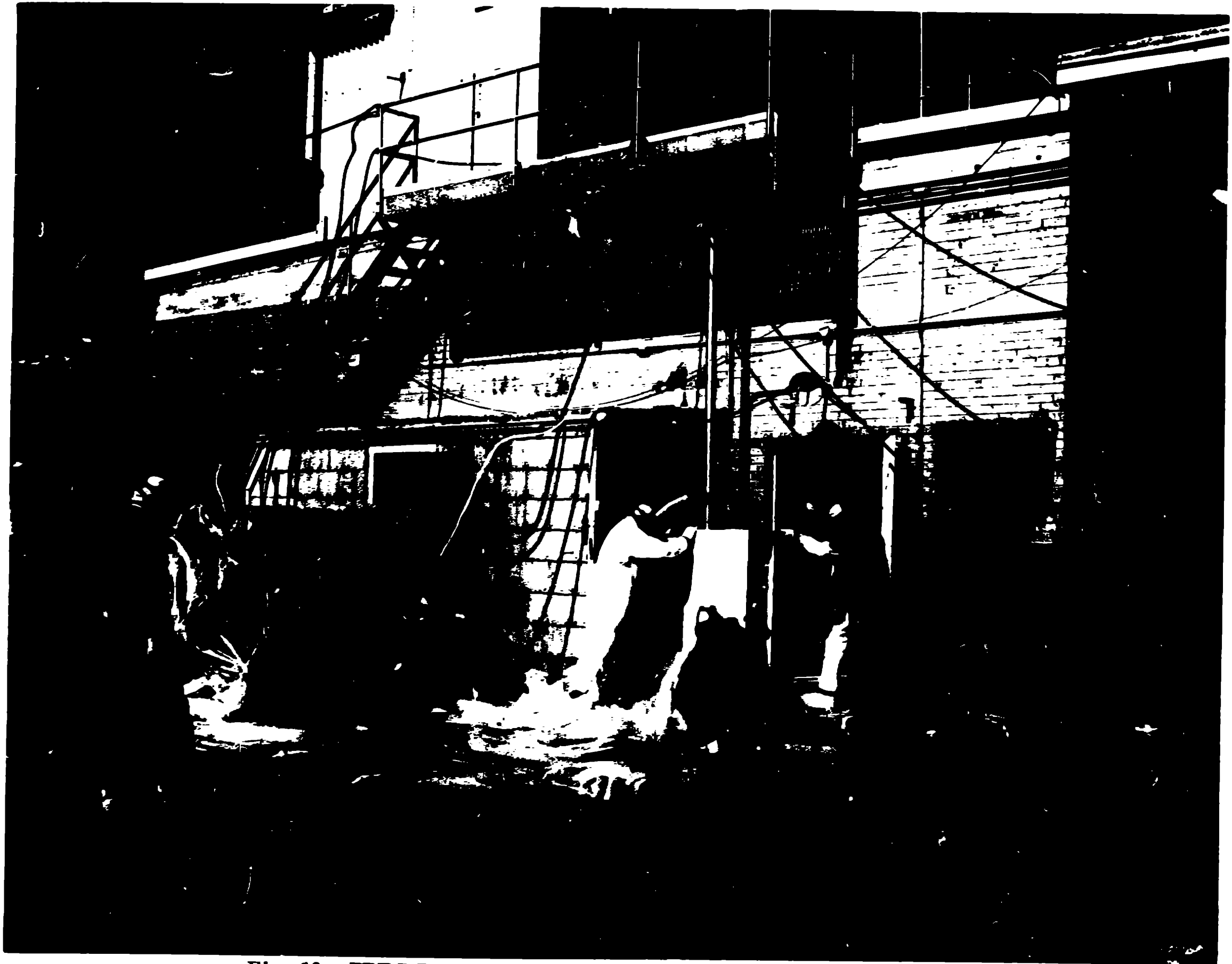

Fig. 10. PRECIPITRON FRAME BEING ROLLED ONTO PLASTIC SHEETING

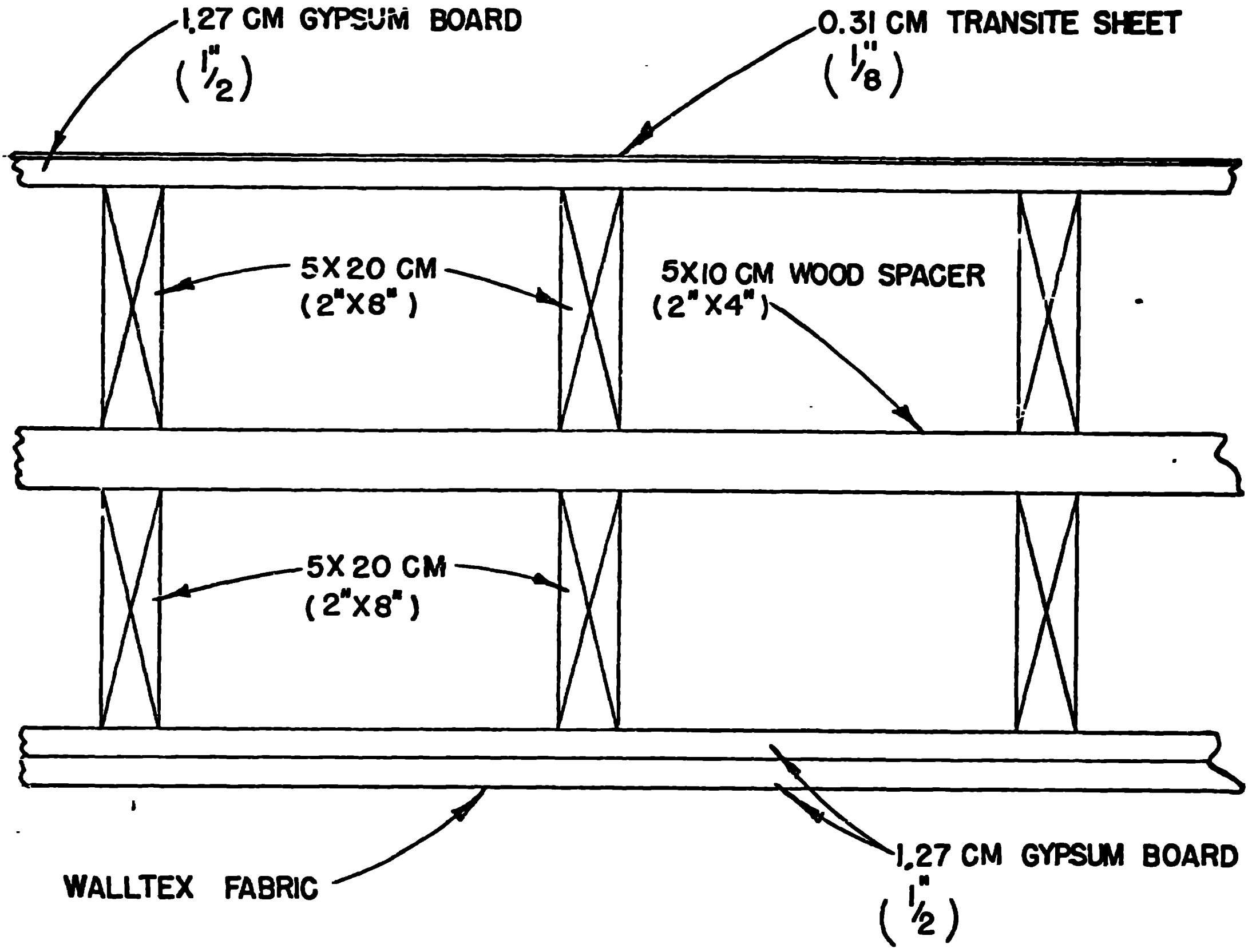



**Fig. 11. PRECIPITRON FRAME BEING WRAPPED IN PLASTIC  
READY FOR LOADING**



**Fig. 12. PRECIPITRON FRAME READY FOR HAULING TO DISPOSAL SITE**



-24-

FIG 13 DETAILS OF ROOF CONSTRUCTION

the nails from pulling through the gypsum board when the plenum was at its lower air pressure during operation.

The roof was built of 2 layers of gypsum board on top of the beams and covered by a 0.3 cm layer of transite. The final layer was a hot tar and 114 kg of roofing paper application.

After the metal strips had been pulled from the ceiling the surface layer, which was fabric covered with several coats of paint, could be easily pulled off leaving a nearly contamination free surface.

The construction of the walls and the floor are shown in Fig. 14. The walls were built with 2 layers of gypsum board nailed to the inside of the 5 cm x 20 cm studs. Here, too, the gypsum board could be pulled off without spreading contamination to the studs. All exposed surfaces were immediately covered with a coat of paint to seal porous surfaces.

The construction at the wall and floor junction consisted of overlapping layers of gypsum board, expansion joint material and gunnite. This construction had kept the sill from becoming contaminated, and by removing the expansion joint material along with a strip of the gunnite, the sill was exposed free of contamination. The rest of the gunnite was given several coats of paint, until all of the contamination was covered, and allowed to remain on the floor for removal along with the foundation.

At this time samples were taken of the soil under the floor and analyzed for gross alpha activity. The results, discussed later, showed that the soil was contaminated in certain areas and would have to be removed to

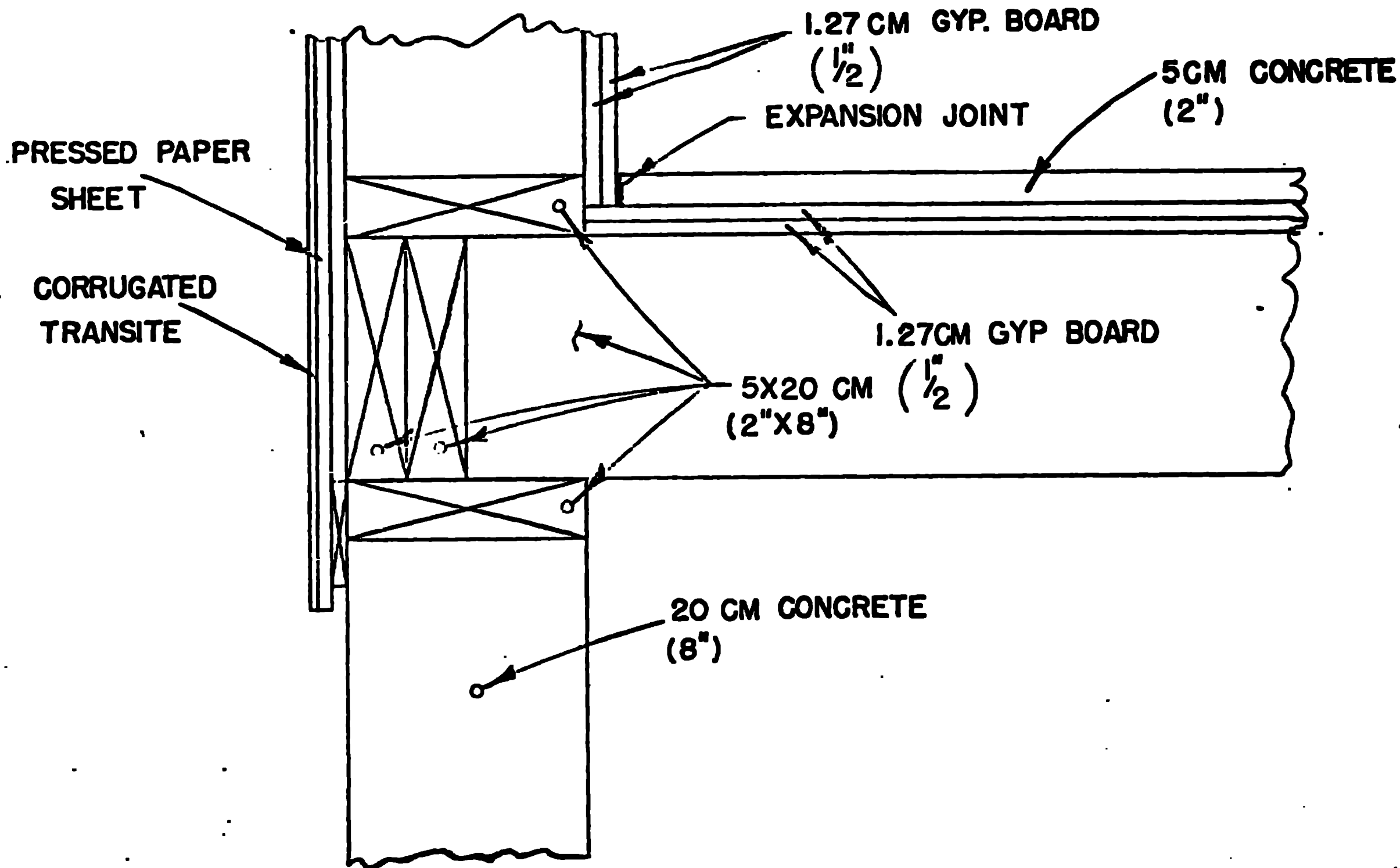

FIG 14 DETAILS OF FLOOR AND WALL CONSTRUCTION

leave a clean site.

This completed the first stage of demolition on the plenum area, leaving the plenum in such a condition that demolition could be completed using power equipment to tear down roof and walls in a more normal manner. The appearance of the interior of the intake plenum is shown in Fig. 15, and the appearance of the area which had housed the precipitrons and filters is shown in Fig. 16.

In the penthouse area the interior wall covering was also removed without spreading contamination to the wall studs. The floor, however, was built of 5 cm x 10 cm tongue and groove boards and the cracks between the boards were filled with contaminated dirt which could not be fixed, even with several coats of paint. Therefore, all of the floor boards were pried loose and painted individually to fix the contamination so that they could be removed from the building and crated for burial. The appearance of the interior after removal of floor and interior surface of the walls of the penthouse is shown in Fig. 17.

These interior floor boards and the gypsum wallboard were packed in plywood boxes and hauled to the burial site after the boxes were banded and sealed.

The external siding was built of paperboard nailed to the 5 cm x 20 cm studs covered with corrugated asbestos siding. The asbestos siding was removed, monitored for alpha contamination and hauled to the LASL waste disposal site leaving the building as shown in Fig. 18. Since no alpha



Fig. 15. INTAKE PLENUM AFTER STRIPPING AND PAINTING

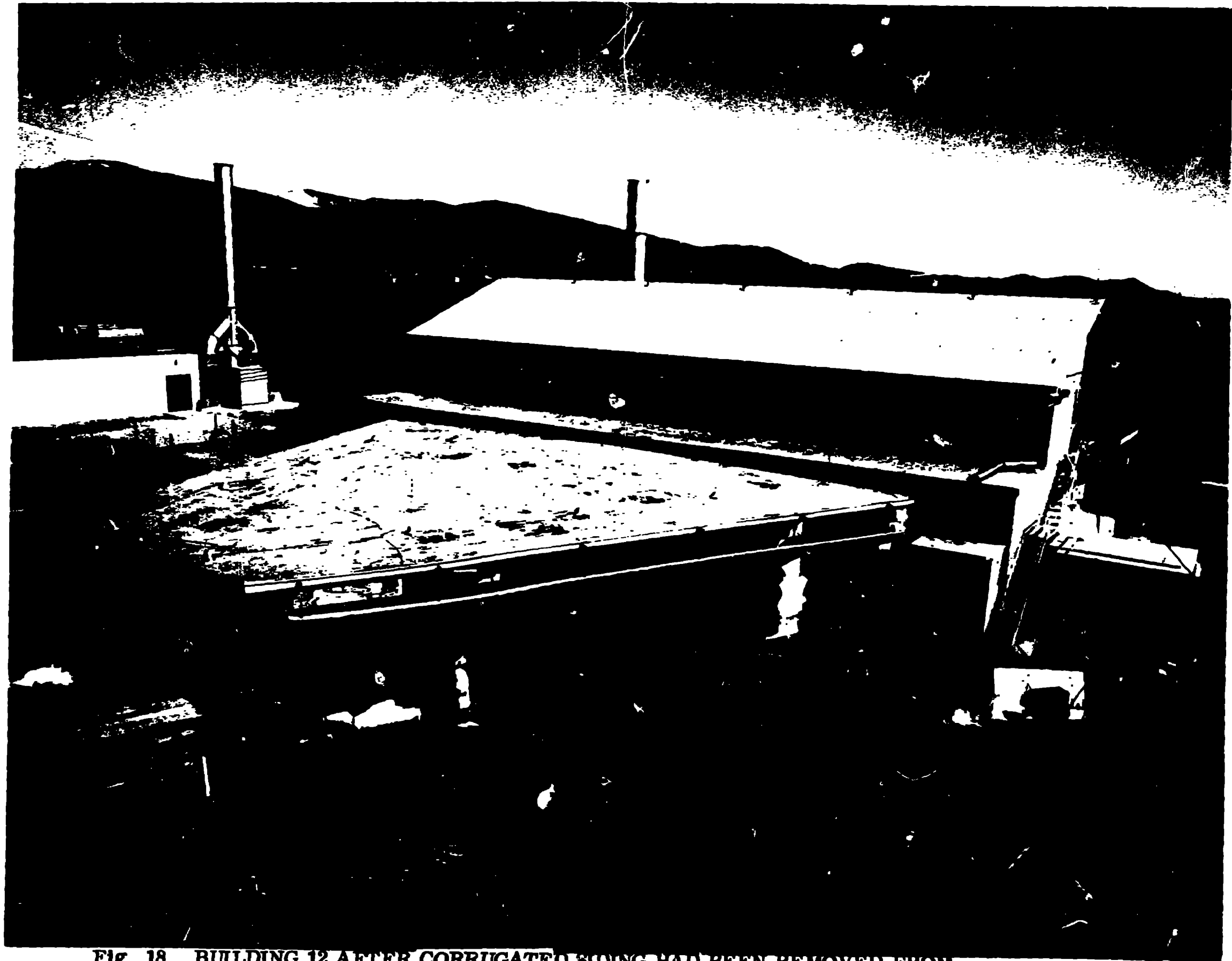

Fig. 16. PRECIPITRON AND FILTER AREA AFTER STRIPPING AND PAINTING





Fig. 17. INTERIOR OF PENTHOUSE AREA AFTER STRIPPING AND PAINTING



**Fig. 18. BUILDING 12 AFTER CORRUGATED SIDING HAD BEEN REMOVED FROM INTAKE PLENUM WALL**

contamination was found on any of the siding it was hauled to the disposal site in an open dump truck.

After the exhaust plenum, blower plenum, precipitron area, and the penthouse area had been stripped, cleaned and painted as discussed earlier, a survey for alpha contamination showed that all contaminated surfaces or items had been removed or decontaminated and painted. The only exceptions were the soil under the floor, and the expansion joints in the concrete floor. The steel columns that held the ten large doors could not be dismantled without the use of cutting torches and because of the wood construction it was decided to leave the steel standing and tear down the building around the steel. When all combustible material had been removed, the steel could be cut up and loaded on a truck to be hauled to the disposal site. The removal of the steel will be discussed later.

Since the interior had been stripped and cleaned as much as possible the next step was to shut down the last blower and to remove the last bank of filters. This would leave the building without any ventilation so a 300 m<sup>3</sup>/min blower was installed so that air would be exhausted through a HEPA filter from the area where the last filters would be removed.

While blower number 4 was still running, and before the 300 m<sup>3</sup>/min blower was started, the filters were coated with water-base spray paint to fix the dust and contamination. Just as the filters began to plug the large blower was shut off and the 300 m<sup>3</sup>/min blower started.

The filters and frames were then removed using the same technique

as for the other filters and frames. After bay 5 was stripped and cleaned the building was surveyed again for alpha contamination. When all loose contamination and detachable items had been removed and all areas had been painted at least three times to cover impregnated contamination, the decision was made that the remainder of the building could be safely torn down and loaded onto trucks with equipment working from the outside.

Since no contamination could be detected on the remaining portions of the walls, it was decided to pull the penthouse over with a cable as if it was a normal building being razed. This was done, exposing the steel beam door supports. Figs. 19 and 20 show the building with most of the penthouse gone. As portions were pulled down, the long boards were cut into 2.5 metre sections with chain saws. The pieces were checked for contamination and then loaded into a dump truck fitted with plywood sides, canvas top and rear flap. Only rarely was any contamination found and when it was the area was immediately painted.

The remainder of the walls and ceiling for the blower room, which never had been contaminated, were broken apart and loaded on a truck with a payloader. The concrete foundations were broken loose with a bulldozer. As will be seen later, the foundations were quite deep and thick and required a large bulldozer and considerable handwork before they could be loaded onto the dump truck.

After the work on the penthouse and blower room was completed, work

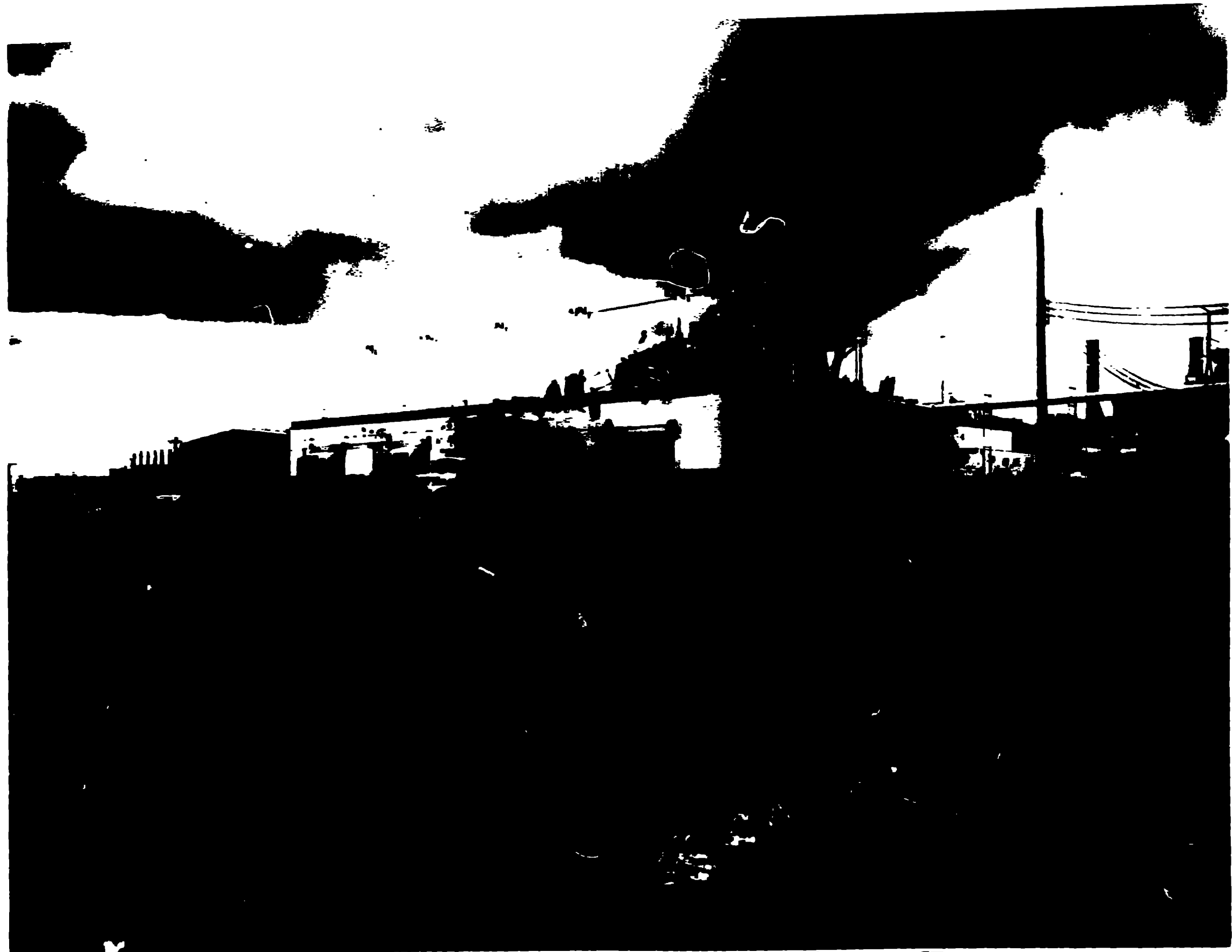

**Fig. 19. GROUND LEVEL VIEW PENTHOUSE AREA AFTER REMOVAL OF MOST OF THE WALLS AND ROOF**



**Fig. 20. ROOF LEVEL VIEW OF PENTHOUSE AREA, AFTER REMOVAL OF MOST OF THE WALLS AND ROOF**

was started on the intake plenum. The roof was pulled down with cables and the debris hand loaded into the covered truck. Then the walls were pushed over, dismantled and loaded into the covered truck. Fig. 21 shows this area when one of the walls had been pushed over. When this work was completed the building was reduced to the brick and steel remaining in the precipitron area and the floor of the intake plenum area.

The next stage was to tear out the intake plenum floor with a payload loader. The foundation was quite extensive as can be seen in Fig. 22. Note that the concrete at the point where the external foundation intersects with the internal foundations was often 46 cm thick. The foundation was 1.52 metres deep and since it was known that some of the soil inside was contaminated, the decision was made to have the equipment dig deep enough to go beneath the foundation and load foundation, soil and floor at the same time. Fig. 23 shows the equipment in the process of removing the plenum floor area.

When this was completed the building was reduced to the steel, brick and concrete shown in Fig. 24.

An attempt was made to pull some of the steel down with a cable and in the process break some bolts and rivets so that the individual beams could be loaded on a truck. Unfortunately, the construction was such that when the bulldozer pulled on a piece of steel at the end of the

-37-



**Fig. 21. INTAKE PLENUM AFTER EAST WALL HAD BEEN  
PULLED DOWN**



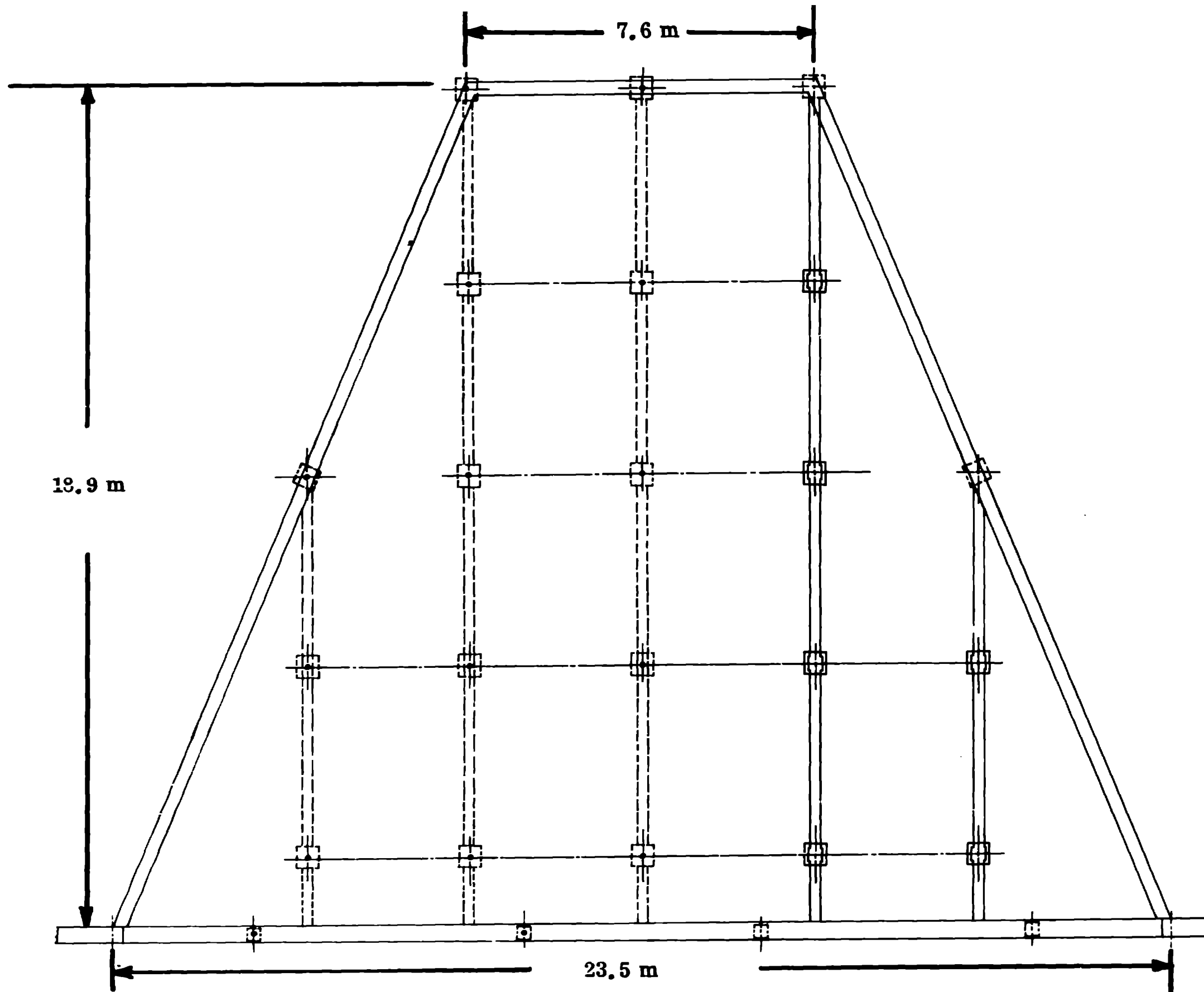

Fig. 22. FOUNDATION FOR INTAKE PLENUM

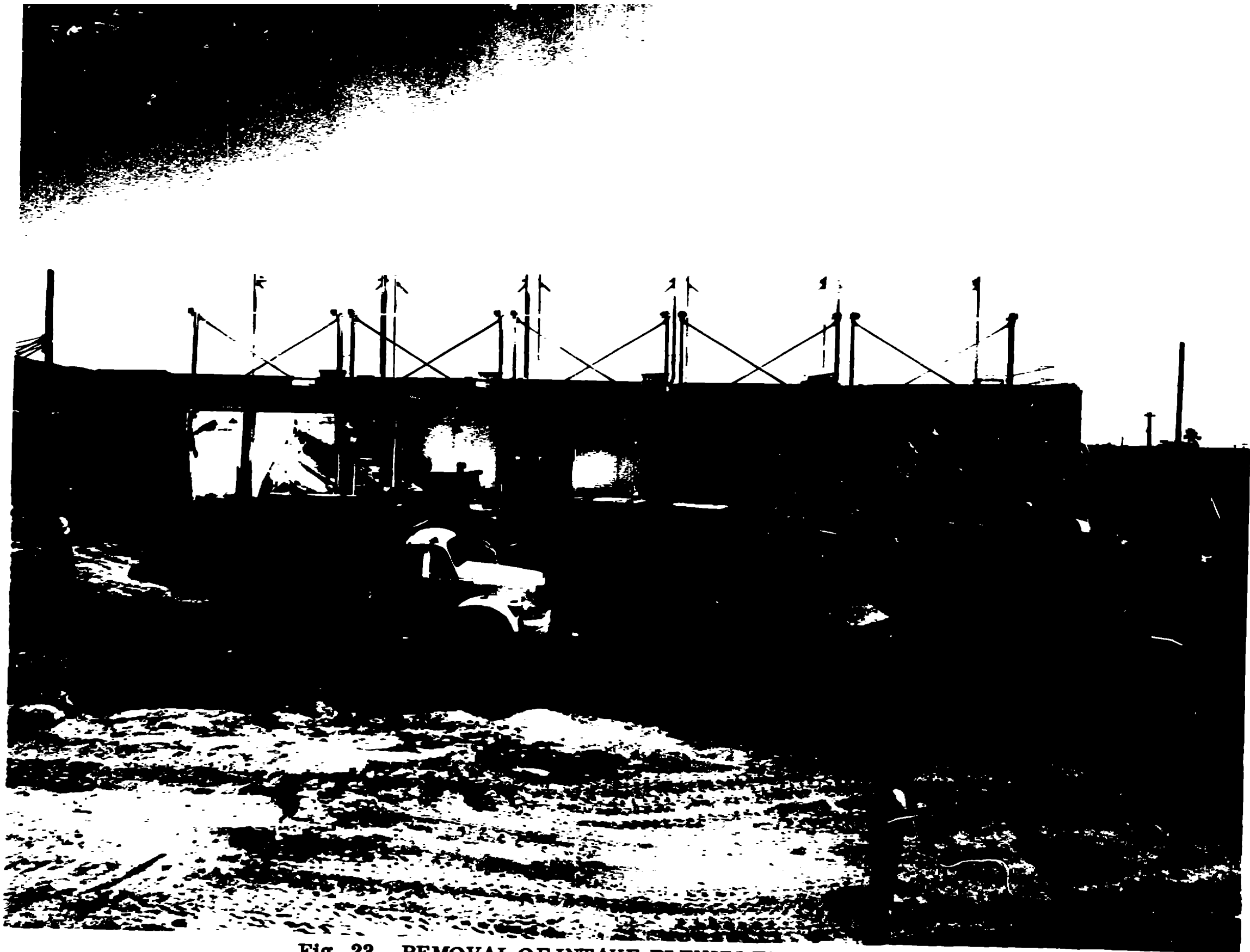
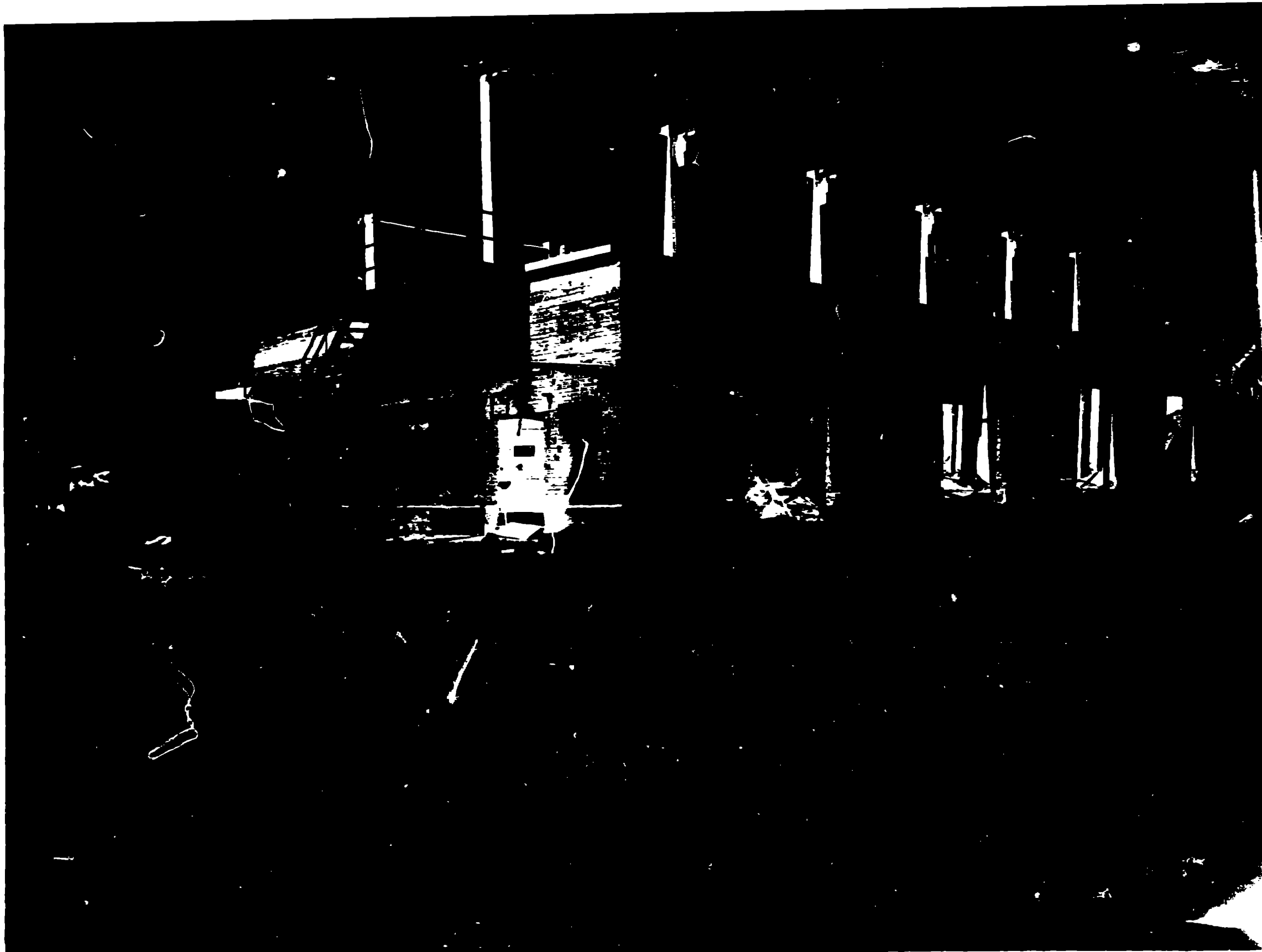

Fig. 23. REMOVAL OF INTAKE PLENUM FLOOR



**Fig. 24. PRECIPITRON AND FILTER AREA AFTER BLOWER ROOM AND INTAKE PLENUM HAD BEEN REMOVED**

building the whole steel assembly toppled over and became the tangled mess shown in Fig. 25. The steel then had to be cut apart with cutting torches and loaded onto an open dump truck with a crane. Figs. 26, 27, and 28 show various facets of this operation.

When the steel had been cleared away only the concrete floor and foundations in the precipitron and filter area remained as shown in Fig. 28. A bulldozer (see Fig. 29) was used to lift the floor slabs up and push them ahead of the treads to an area where the payloader could get to them for loading on a dump truck. The only contaminated areas on these slabs were the edges that had been in contact with the expansion joints. These areas were painted before the payloader loaded the slabs on the truck. Then the bulldozer was used to loosen and break the foundation into pieces small enough to load onto the dump truck. Most of the foundation was 15 to 20 cm thick and 1.5 metres deep. However, one piece of the foundation was nearly 75 cm wide, 1.5 metres deep and 30 metres in length. Efforts to break this foundation into small chunks with the bulldozer proved fruitless. Hence, this 30 metre piece of foundation had to be weakened by drilling a series of holes as a perforation line. Such a line of holes can be seen in Fig. 30. The bulldozer was then able to break this foundation into pieces small enough to be lifted onto the dump truck. Fig. 31 shows the removal of the last concrete and dirt from the site.

The final task was the removal of the drain pipe that led from the



**Fig. 25. APPEARANCE OF STRUCTURAL STEEL AFTER ATTEMPT TO  
PULL DOWN INDIVIDUAL PIECES**

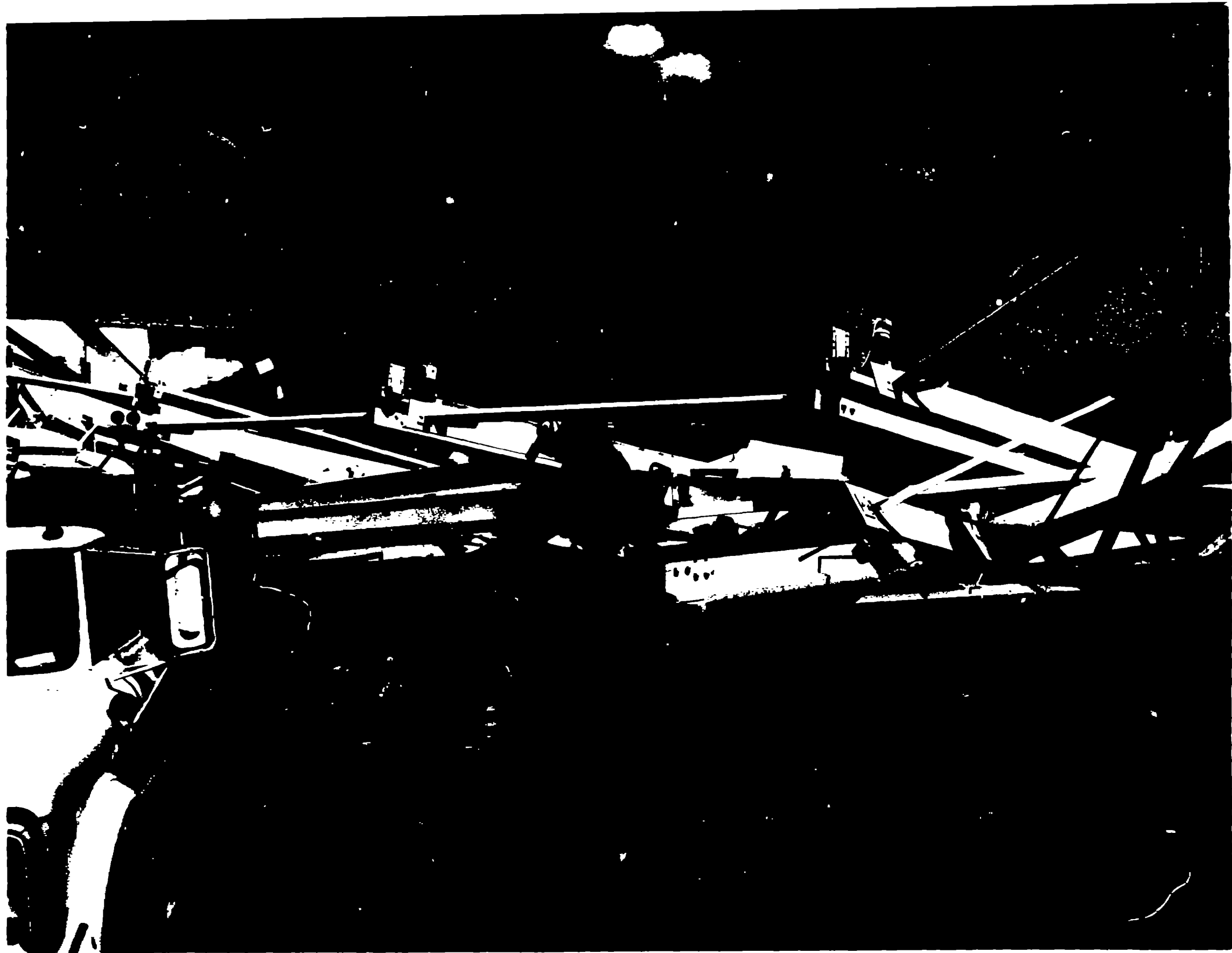
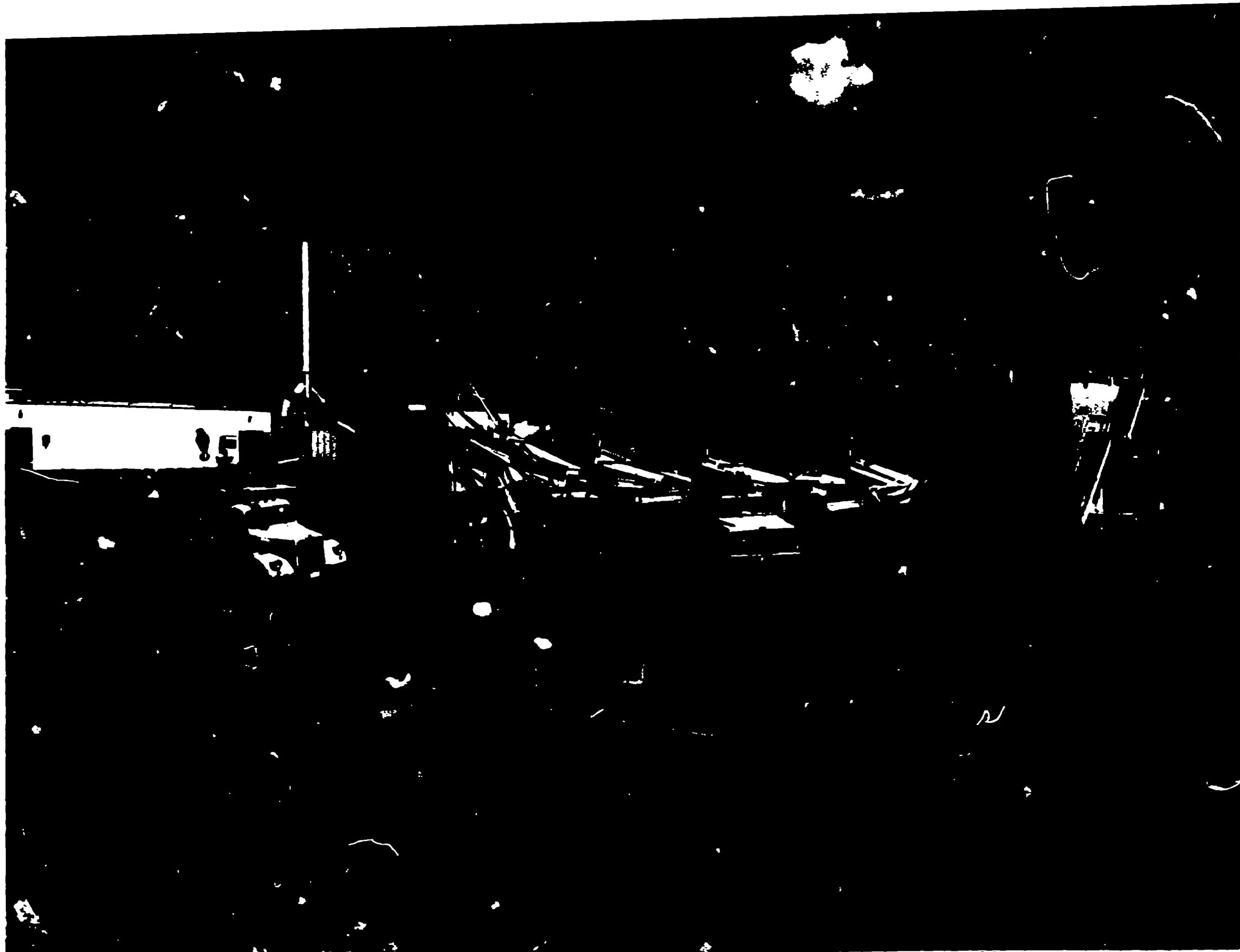

Fig. 26. CUTTING STEEL BEAMS WITH WELDING TORCH



-4-

Fig. 27. LOADING STEEL BEAMS ONTO TRUCK FOR DISPOSAL



**Fig. 28. PRECIPITRON AREA WHEN MOST OF THE STEEL HAD  
BEEN REMOVED**





-46-

**Fig. 29. BULLDOZER REMOVING CONCRETE FLOOR  
IN PRECIPITRON AREA**



Fig. 30. PART OF CONCRETE FOUNDATION

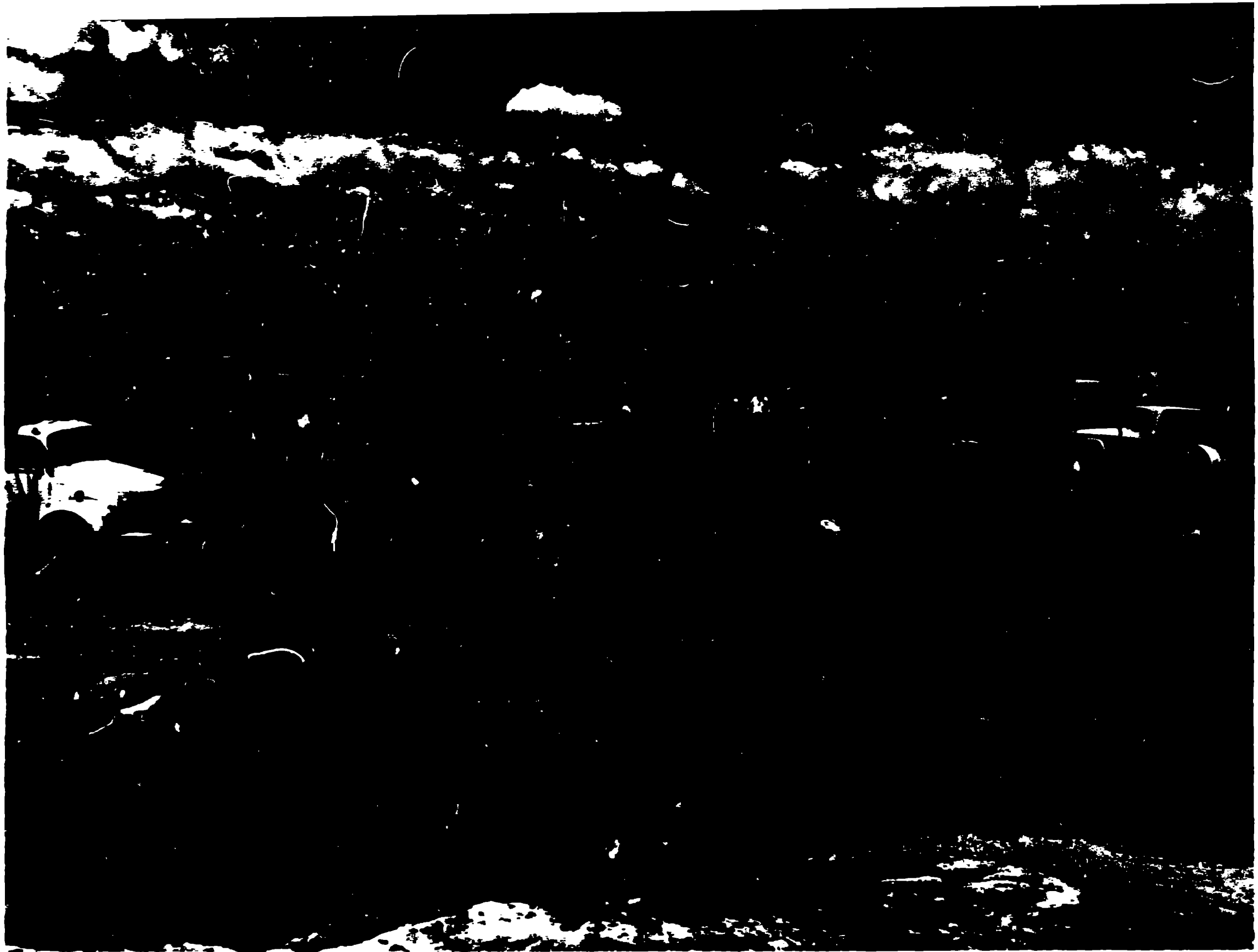

Fig. 31. REMOVING THE LAST CONCRETE AND DIRT

precipitron and filter area to a tile field. The tile field had been removed several years earlier but the plugged drain line leading from Building 12 to the tile field remained in place. Workers engaged in removing the drain line are shown in Fig. 32. This cast iron drain line had been embedded in the soil for nearly 30 years and yet corrosion had penetrated less than 0.16 cm (< 1/16 inch).

When this drain line had been removed, the trench and the area that had been occupied by the building were surveyed for alpha contamination. When no alpha contamination was detected, soil samples were taken for analyses and the area was backfilled with dirt until the original ground contour had been restored. Native grasses were planted as a ground cover as the final step in the demolition of Building 12. Fig. 33 shows the area after completion of the backfilling operation.

The demolition work was started in February and completed in July, 1973 at a total cost of approximately \$160,000. Craftsmen used on this project were riggers, painters, laborers, equipment operators, truck drivers, carpenters and electricians.

## 5. Health Physics

Personnel assigned to do the demolition were inexperienced in dealing with plutonium contamination, but they were provided with formal health physics instruction and with day-to-day instructions from the plutonium plant supervisor and from health physics technicians who were present during all phases of the project. All workers also participated in a full



Fig. 32. REMOVING DRAIN LINE

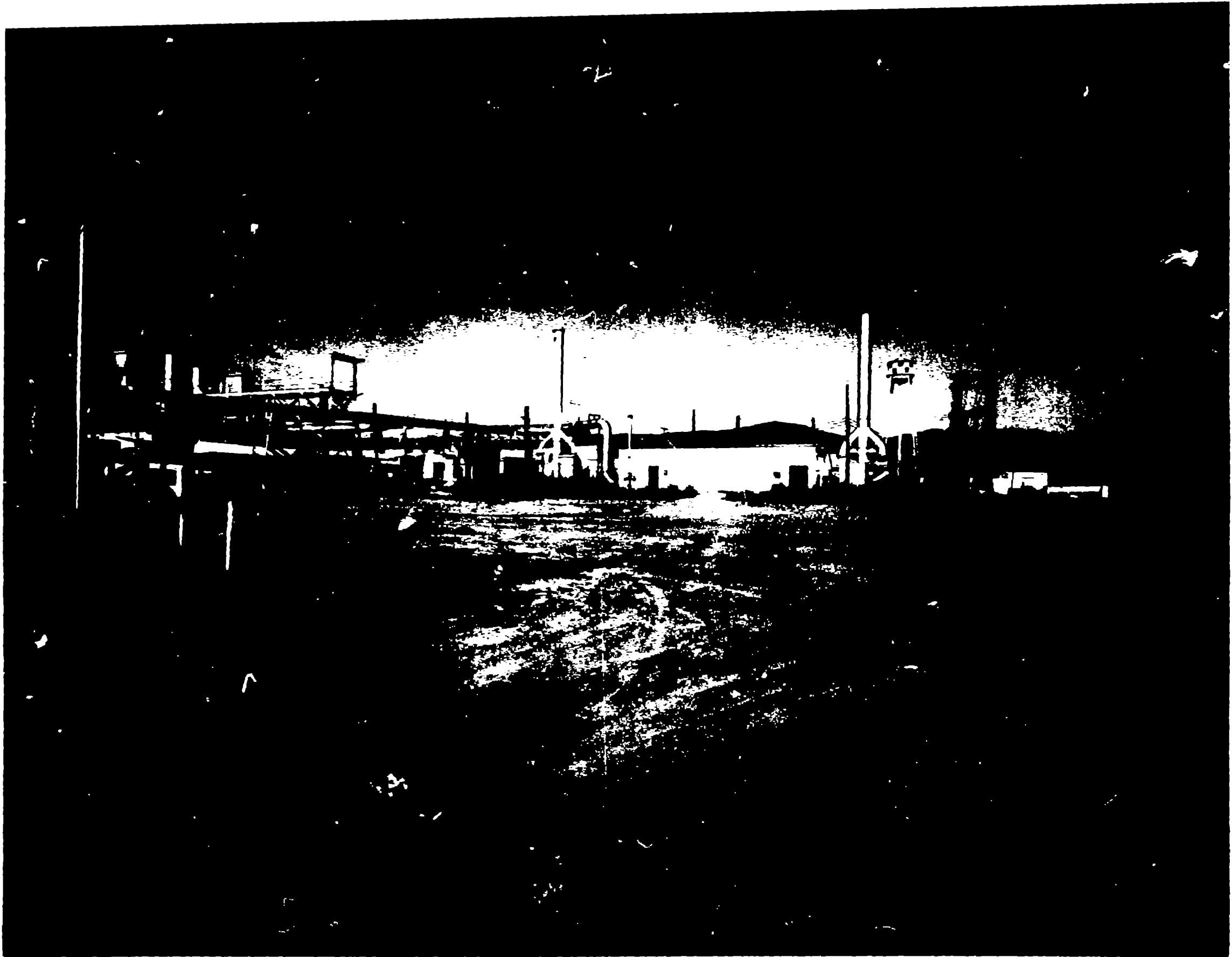

Fig. 33. VIEW OF SITE AFTER COMPLETION OF DEMOLITION

face respirator fitting and testing program. Full face respirators equipped with high efficiency particulate filters were the standard mode of respiratory protection used during all phases of demolition that involved work with loose contamination. During prior decontamination work in 1960, supplied air suits were used.

Demolition workers were provided protective (anti-contamination) clothing for work in the area. For work inside the building, workers were double-suited with coveralls, booties, a cap and hood, gloves, and underwear. (Fig. 34) Disposable paper coveralls and hoods were used for the outer garments along with plastic booties. The outer garments were overlapped and taped together and openings in both coveralls were taped shut. This procedure provided adequate protection against worker contamination during the demolition since no personnel decontamination beyond normal showering and washing procedures was required.

The air in the working area was sampled by drawing air through HV-70 filter paper at the nominal rate of 0.56 m<sup>3</sup>/min. The paper was removed and counted daily for alpha activity to provide a record of the air contamination that the workers were exposed to. On four occasions the air borne plutonium concentration exceeded  $2000 \times 10^{-12} \mu\text{Ci/ml}$ , but during most of the remaining work days the concentration ranged from 50 to  $150 \times 10^{-12} \mu\text{Ci/ml}$  with some as low as  $2 \times 10^{-12} \mu\text{Ci/ml}$ .

All personnel working on the project were provided monthly beta-gamma and neutron film badges to record external radiation exposures.



Fig. 34. WORKER SUITED UP FOR DEMOLITION WORK



The highest monthly recorded exposure was 40 mrem. Alpha contamination surveys and nose swipe monitoring practices varied somewhat with the assigned task and level of contamination involved, but the minimum was the survey of all workers for alpha contamination prior to leaving the area and the collection of nose swipes after work requiring use of respiratory protective equipment. A few cases of hand contamination occurred; however, all were decontaminated by normal showering and washing methods. Of 1195 nose swipes collected only four were > 10 d/min alpha with 85 d/min being the highest single result. Workers submitted urine samples for plutonium analysis at the beginning and completion of the job. Most workers were given plutonium chest counts at the job completion. No measurable increase in plutonium body or lung burden was indicated by the results of the urinalysis and chest counting programs. One (1) minor injury occurred during the job. The wound, caused by a nail puncture, was monitored by alpha and x-ray monitoring techniques and found to be free of plutonium contamination.

#### 6. Waste Management

Waste materials were packaged in different ways depending on size and contamination level to make safe transport and disposal possible. Small items and highly contaminated larger items which could be reduced in size were placed in plastic lined 0.56 m<sup>3</sup> cardboard boxes. The bags and boxes were sealed with tape to prevent leaks during disposal.

Approximately 1320 cardboard boxes were filled with waste and disposed of by burial at LASL's solid radioactive waste disposal site located about 9 km from the demolition site. The location of this site is shown in Fig. 33. Larger items such as filters, filter frames, gypsum board pieces, and metal trim were wrapped in plastic and placed in 69 plastic lined plywood crates (1.2 x 1.2 x 2.4 metres) for burial at the disposal site. In addition to the boxed and crated waste, approximately 1200 m<sup>3</sup> of contaminated transite, doors, lumber, pipes, roofing materials, and metals were taken to the disposal site in covered dump trucks. Fixing the contamination on large items with multiple coats of paint allowed handling, transport, and disposal without vehicle or personnel contamination problems. In addition to the waste already mentioned, approximately 400 m<sup>3</sup> of concrete, dirt, and large metal items were buried in a disposal site located at TA-21, 300 metres from the building site.

All waste packages and unpackaged items were monitored for plutonium contamination with portable alpha survey instruments. The waste was disposed of by burial as non-retrievable < 10 nCi/g plutonium waste. The wastes that contained > 10 nCi/g plutonium had been placed in retrievable storage during decontamination work prior to the actual demolition.

Trucks, loaders and bulldozers used to load and/or transport contaminated materials were monitored during the job and decontaminated as necessary. The equipment did not become highly contaminated and

washing with cold water was sufficient to reduce contamination levels to less than 100 dis/min per 60 cm<sup>2</sup>.

During the 109 days required for the demolition work and site clean-up, a total of 235 man-days of health physics technician effort were required for personnel and miscellaneous monitoring.

## 7. Environmental Air Monitoring

The LASL's Environmental Studies Group monitored the environmental impact of the demolition operation with its routine air sampling network and a special on-site sampling program.

The routine air sampling network consisting of 36 sampling stations was supplemented with two additional stations to more adequately encircle the demolition site with samplers. The positioning of the supplemental samplers was limited somewhat by the availability of electrical power and access to the equipment. The location of these sampling stations (with the exception of the Santa Fe, Espanola, and Pojoaque stations) and of the demolition site are shown in Fig. 35.

The 38 samples were collected each week. Air was drawn through a 78 mm Microsorban filter having an efficiency of about 99.8% for 0.3  $\mu$  m dioctylphthalate (DOP) particles (a standard test aerosol for determining filter efficiency) at a rate of either 70 litres per minute or 200 litres per minute. The two different rates were due to a continuing program of replacing the 70 l/min. pumps with pumps of higher capacity and less maintenance requirements.

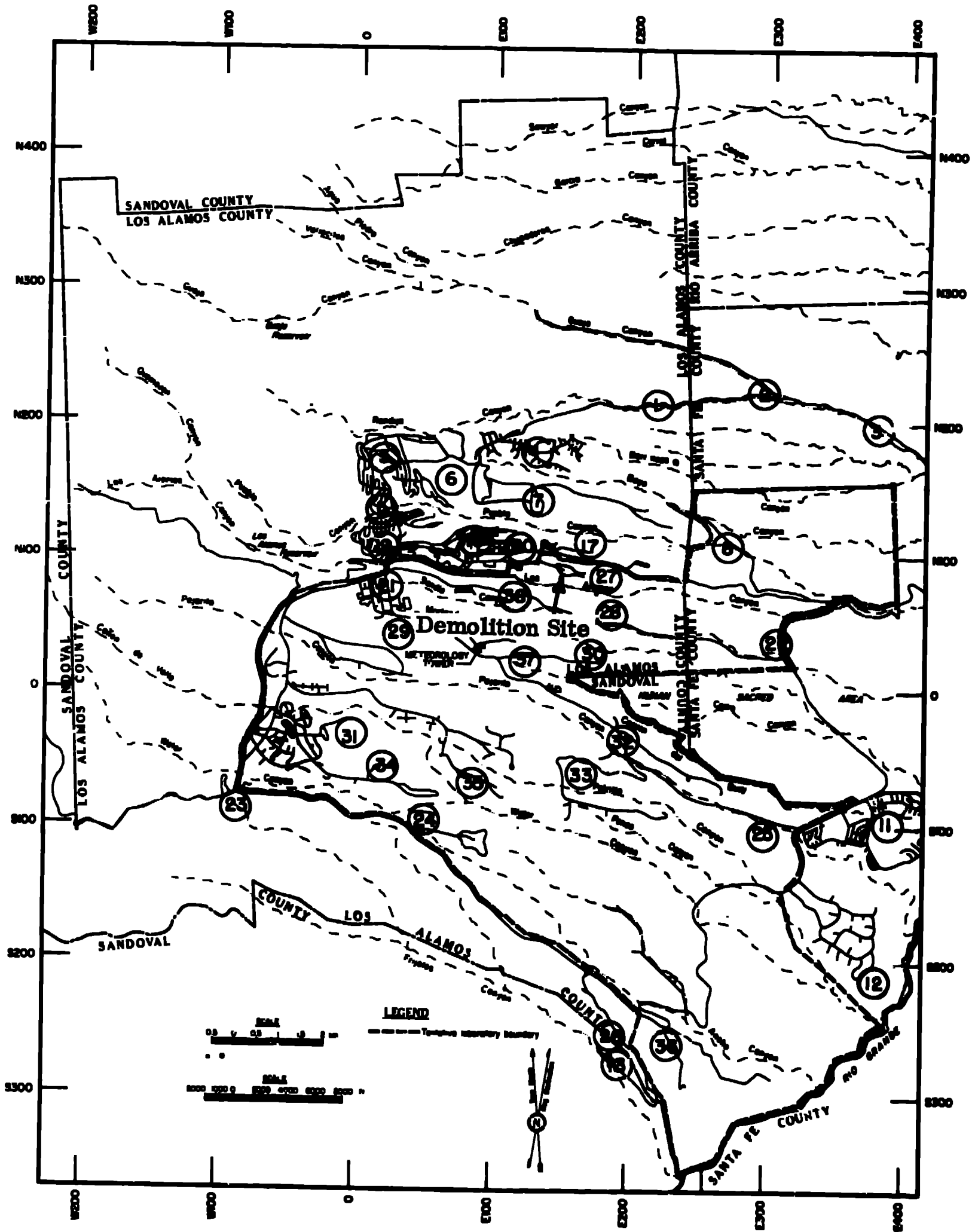

FIG. 35

LOCATION OF DEMOLITION SITE AND AIR SAMPLING STATIONS

This weekly collection schedule was not intended to provide an early detection of a plutonium release but to help in documentation of the magnitude of an accidental release. Meteorological data were available for TA-21 during the entire operation and could have been utilized if a high gross alpha concentration was detected at any of the sampling stations. Since no concentration of any significance was detected it was not necessary to use these data to determine the pollution source.

The samples were handled routinely; they were counted after a one-day decay period and then recounted after approximately a 10 day decay period for the records. This allowed for the decay of natural radon and thoron daughters. During the demolition both measurements were observed and compared to background levels to detect any abnormal concentrations. An attempt was made to compare the 10-day measurement data from this period to the corresponding 17 weeks of 1972 to eliminate seasonal background variations, but because the data for those weeks in 1972 had been influenced by fallout from a Chinese Nuclear Test, no meaningful comparison was possible. Instead, the data were compared to the 1972 averages to minimize the impact of the Chinese fallout. These data are presented in Table 3 and indicate that if plutonium was released to the environment during demolition it was minimal and had no detectable impact on the overall gross alpha background levels in the vicinity of the LASL.

**TABLE 3 GENERAL SURVEILLANCE AIR MONITORING RESULTS**  
**Average Gross Alpha Concentrations<sup>a</sup>**  
**(x 10<sup>-15</sup> µCi/ml)**

Station Number	Map Coordinates	1972	1972	1973
		4/5 thru 7/26	1972	4/5 thru 8/1
<b>Off site:</b>				
1	N220 E220	1.8 ± 2.2	2.0 ± 0.6	1.2 ± 0.6
2	N220 E300	2.3 ± 2.6	1.9 ± 0.6	0.8 ± 0.4
3	N200 E380	1.7 ± 2.4	1.7 ± 0.6	1.4 ± 1.0
4	N180 E130	1.5 ± 1.6	1.6 ± 0.4	1.0 ± 0.6
5	N170 E 20	2.2 ± 2.8	1.6 ± 0.6	1.2 ± 0.8
6	N160 E 60	2.2 ± 2.6	1.5 ± 0.6	1.3 ± 1.0
7	N150 E490	1.7 ± 1.8	1.7 ± 0.4	1.4 ± 0.8
8	N140 E130	1.5 ± 2.2	1.7 ± 0.6	1.3 ± 1.0
9	N130 E 20	1.8 ± 2.2	1.6 ± 0.6	1.5 ± 0.8
10	N110 E 90	2.0 ± 2.6	1.6 ± 0.6	1.3 ± 0.6
11	S 90 E390	1.8 ± 2.2	1.6 ± 0.6	1.4 ± 0.6
12	S210 E370	1.5 ± 2.4	1.3 ± 0.6	0.9 ± 0.6
13	S270 E190	1.0 ± 2.0	1.5 ± 0.4	1.3 ± 0.8
14	-	3.3 ± 2.8	2.1 ± 1.0	1.5 ± 1.0
15	-	-	-	1.2 ± 1.2
16	-	3.3 ± 4.2	2.0 ± 0.8	0.8 ± 1.0
<b>Perimeter:</b>				
17	N110 E160	2.7 ± 3.6	1.9 ± 0.8	0.8 ± 0.6
18	N110 E260	1.3 ± 2.0	1.6 ± 0.8	1.0 ± 0.8
19	N100 E 20	1.9 ± 2.4	1.5 ± 0.6	1.4 ± 1.2
20	N100 E110	1.8 ± 2.8	1.4 ± 0.6	1.0 ± 0.6
21	N 80 E 10	1.7 ± 2.8	1.5 ± 0.6	1.2 ± 0.6
22	N 30 E310	1.8 ± 2.8	1.5 ± 0.6	0.8 ± 0.4
23	S 80 W 90	2.2 ± 2.4	1.5 ± 0.6	1.1 ± 0.8
24	S100 E 40	1.6 ± 1.8	1.5 ± 0.6	0.8 ± 0.6
25	S100 E300	2.1 ± 2.2	1.6 ± 0.6	1.1 ± 0.6
26	S270 E200	1.9 ± 2.0	-	1.3 ± 0.8
<b>On-Site:</b>				
27	N 90 E170	1.6 ± 1.8	1.3 ± 0.4	0.8 ± 0.4
28	N 60 E180	3.0 ± 4.4	2.2 ± 0.8	1.0 ± 0.4
29	N 40 E 20	1.9 ± 3.2	1.5 ± 0.6	1.0 ± 0.6
30	N 20 E170	2.6 ± 4.2	1.6 ± 0.4	1.0 ± 0.6
31	S 30 W 10	1.3 ± 2.2	1.1 ± 0.4	1.1 ± 0.8
32	S 30 E190	1.8 ± 2.0	1.5 ± 0.4	1.7 ± 1.2
33	S 50 E160	1.5 ± 1.4	1.1 ± 0.4	0.8 ± 0.4
34	S 60 E 10	1.1 ± 1.4	1.2 ± 0.4	1.1 ± 0.6
35	S 70 E 80	1.5 ± 1.8	1.3 ± 0.4	0.8 ± 0.6
36	S250 E230	3.3 ± 5.4	1.9 ± 1.2	1.1 ± 1.0
37	N 20 E110	-	-	1.1 ± 0.8
38	N 70 E115	-	-	1.1 ± 1.0

<sup>a</sup>Average (± two standard deviations)

Air monitoring in the immediate vicinity of the structure was added to provide an early detection of a release of radioactivity. If such a release had been detected the operation would have been curtailed until more protective demolition measures could be employed.

These samples (location of samplers shown in Fig. 36) were collected daily. Due to mechanical failures a variety of sampling devices and rates were used. On April 4, 1973, at the start of the sampling operation the sampling network consisted of four Staplex "Hi-Volume" samplers. They sampled through 76 mm diameter Microsorban paper (similar to the filter media for the weekly samples) at a rate of approximately  $0.37 \text{ m}^3/\text{min}$ . Two of the samplers were located near buildings and used line power; the other two were driven by gasoline powered generators.

By the end of April the samplers had been changed to employ 100 mm Microsorban filters to increase the flow rate and reduce pump heating. The flow increased to approximately  $0.52 \text{ m}^3/\text{min}$ . These samplers were located as shown in Fig. 36 so that they could be operated on line power and were used throughout the remainder of the sampling period. The fourth sampling station was abandoned since three samplers would give adequate coverage. The samplers were not centered around the building, but instead around the center of the demolition activity where releases of contamination were more likely to occur.

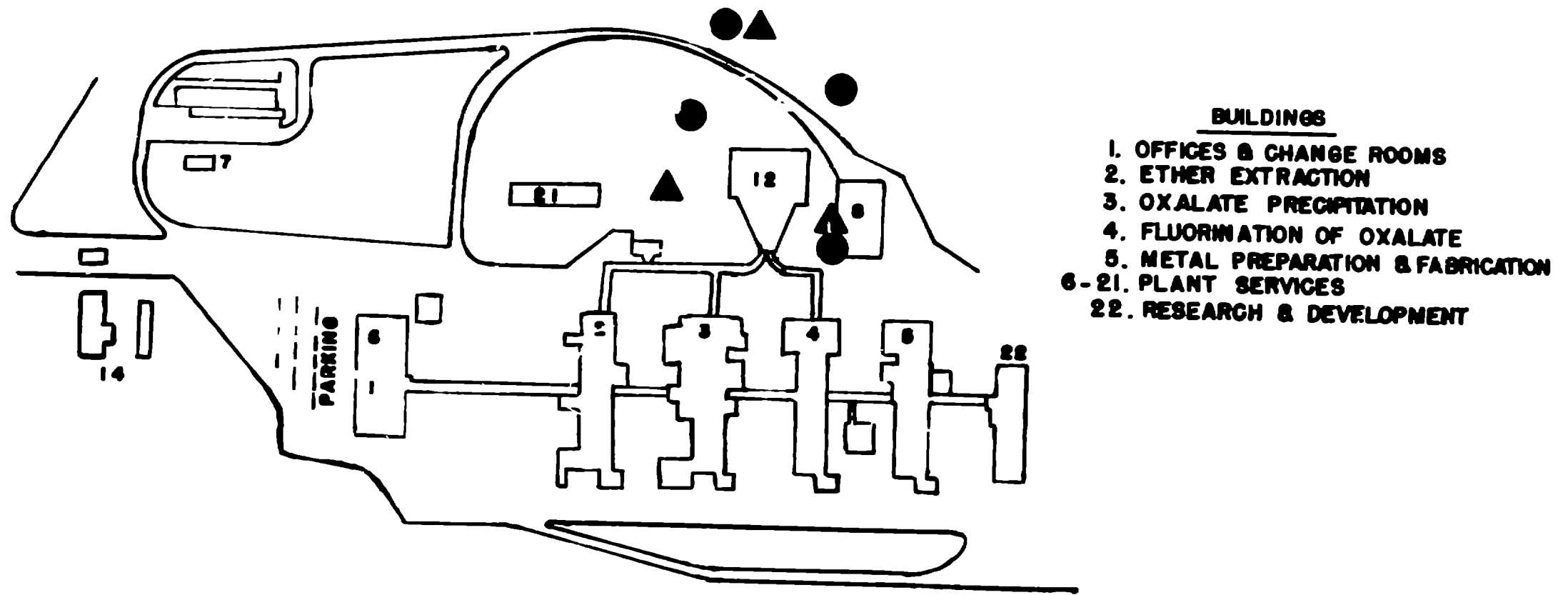

FIG 36. ON SITE (TA-21)  
AIR SAMPLER LOCATIONS

- APPROXIMATE LOCATION OF INITIAL SAMPLING NETWORK
- ▲ APPROXIMATE LOCATION OF FINAL SAMPLING NETWORK



The filters were first counted by Health Physics personnel within an hour after collection for early detection of a release, then counted by environmental studies personnel after allowing two weeks for decay. The average and maximum gross alpha concentration values for the second measurement are compared to AEC Manual Chapter 0524 Concentration Guides for Uncontrolled Areas in Table 4. All of the gross alpha activity was assumed to be insoluble  $^{239}\text{Pu}$  for comparison to applicable concentration guides. The highest twenty-four hour concentration at any on-site sampler ( $8.7 \times 10^{-13} \mu\text{Ci}/\text{m}^3$  on July 5) was 87 percent of the  $1 \times 10^{-12} \mu\text{Ci}/\text{m}^3$  concentration guide for insoluble  $^{239}\text{Pu}$  in controlled areas.

The air that was exhausted by the ventilation blower was sampled by drawing air through HV-70 filter paper at the nominal rate of 0.56  $\text{m}^3/\text{min}$ . The filter papers were measured daily for gross alpha activity. The data indicated that 1371  $\mu\text{Ci}$  of plutonium were released in this manner from February through May, 1973.

#### 8. Soil Sampling

As was mentioned in the Demolition Section of this report, water had escaped the building through expansion joints in the concrete floor during past clean-up operations. Therefore, the concrete was broken and surface and core samples of dirt were collected at suspect locations to determine the magnitude and depth of contamination. The surface

**TABLE 4 ON-SITE (TA-21) GROSS ALPHA CONCENTRATIONS IN AIR**

<u>Sampling Period</u>	<u>Average<sup>a</sup> (± 2 S.D.) (10<sup>-15</sup> µCi/ml)</u>	<u>Percent of CG<sup>b</sup> for Average</u>	<u>Maximum<sup>c</sup> (± 2 S.D.) (10<sup>-15</sup> µCi/ml)</u>	<u>Percent of CG<sup>b</sup> for Maximum</u>
4/4 -4/9/73	4(± 4)	0.4	8(± 1)	0.8
4/10 -4/16/73	11(± 49)	1.1	114(± 5)	11.4
4/17 -4/23/73	2(± 3)	0.2	6(± 1)	0.6
4/24 -4/30/73	11(± 4)	1.1	78(± 9)	7.8
5/1 -5/7/73	3(± 8)	0.3	17(± 8)	1.7
5/8 -5/14/73	8(± 24)	0.8	42(± 15)	4.2
5/15 -5/21/73	73(±418)	7.3	632(±243)	63.2
5/22 -5/28/73	4(± 15)	0.4	28(± 16)	2.8
5/29 -6/4/73	2(± 4)	0.2	6(± 3)	0.6
6/5 -6/11/73	3(± 7)	0.3	15(± 8)	1.5
6/12 -6/18/73	24(± 96)	2.4	112(± 55)	11.2
6/19 -6/25/73	39(± 83)	3.9	166(± 80)	16.6
6/26 -7/2/73	98(±188)	9.8	278(±111)	27.8
7/3 -7/9/73	110(±490)	11.0	869(±347)	86.9
7/10 -7/16/73	10(± 23)	1.0	38(± 15)	3.8
7/17 -7/23/73	2(± 4)	0.2	7(± 3)	0.7
7/24 -7/30/73	1(± 3)	0.1	6(± 2)	0.6
7/30 -8/2/73	1(± 1)	0.1	2(± 1)	0.2

<sup>a</sup>Arithmetic Mean for all 24-hour samples for particular sampling period (± 2 Standard Deviations).

<sup>b</sup>Concentration Guide for insoluble <sup>239</sup>Pu for uncontrolled areas, AEC Manual Chapter 052<sup>4</sup>.

<sup>c</sup>Maximum concentration of any single 24 hour sample during the sampling period (± 2 Stand. Dev.).

samples were collected from the top centimeter of soil with a spoon, and the core samples were collected by driving a 2.54 centimeter diameter polyvinyl chloride (PVC) pipe into the soil with a hammer. The sample locations and the gross alpha concentrations at those locations are shown in Fig. 37 and Table 5 respectively. The data confirmed expectations that some soil underneath the building would be contaminated.

After the building and approximately 30 centimeters of soil had been removed, an attempt was made to survey the remaining 2 metre depression with a low energy x-ray detector. The results of the survey were meaningless, however, because the instrument readings were influenced by radioactive materials stored in a nearby building; therefore, soil core samples were collected at the locations shown in Fig. 38. Samples collected at points 4, 5 and 6 (near the centerline of the building) were divided into the listed segments to determine variation in contamination with depth. Samples from the other locations were analyzed as single samples. Runoff from a rainshower on the previous night that had puddled at the northeast side of the depression was also sampled; its gross alpha concentration was less than the minimum detection limit of  $4 \times 10^{-8} \mu \text{Ci/l}$ .

To arrive at a quick estimate of contamination levels and also minimize the number of plutonium analyses, gross alpha measurements

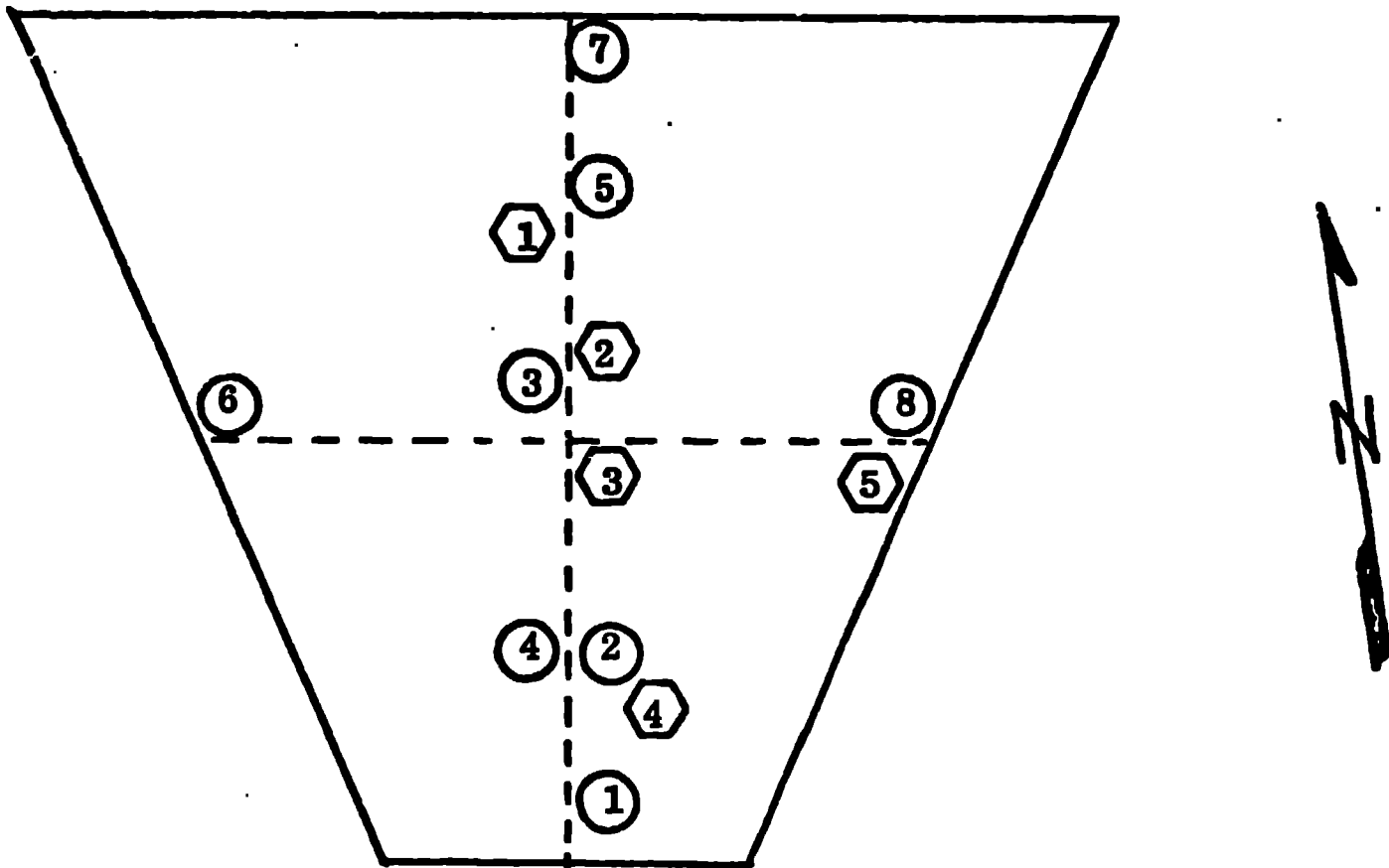

- Surface Sample
- ⬡ Core Sample

**Fig. 37. LOCATIONS OF SOIL SAMPLES TAKEN FROM UNDER INTAKE PLENUM.**

**TABLE 5. GROSS ALPHA CONCENTRATION OF SOIL SAMPLES COLLECTED FROM UNDER INTAKE PLENUM**

Surface Samples		Core Samples		
Sample Location <sup>a</sup>	Gross alpha Concentration pCi/gm	Sample Location <sup>a</sup>	Depth from Surface	Gross alpha Concentration pCi/gm
①	67	①	0 - 2.5 cm	36
②	21	"	6.4 - 8.9 cm	9
③	17	"	12.7 - 15.2 cm	6
④	563	②	0 - 2.5 cm	10
⑤	207	"	6.4 - 8.9 cm	1
⑥	124	③	0 - 2.5 cm	108 000
⑦	4	"	6.4 - 8.9 cm	4 653
⑧	311	"	12.7 - 15.2 cm	3 722
		"	25.4 - 27.9 cm	446
		④	0 - 2.5 cm	30
		"	6.4 - 8.9 cm	4
		⑤	0 - 2.5 cm	33
		"	6.4 - 8.9 cm	10
		"	12.7 - 15.2 cm	21
		"	20.3 - 22.9 cm	20

<sup>a</sup> See Figure 37 for location.

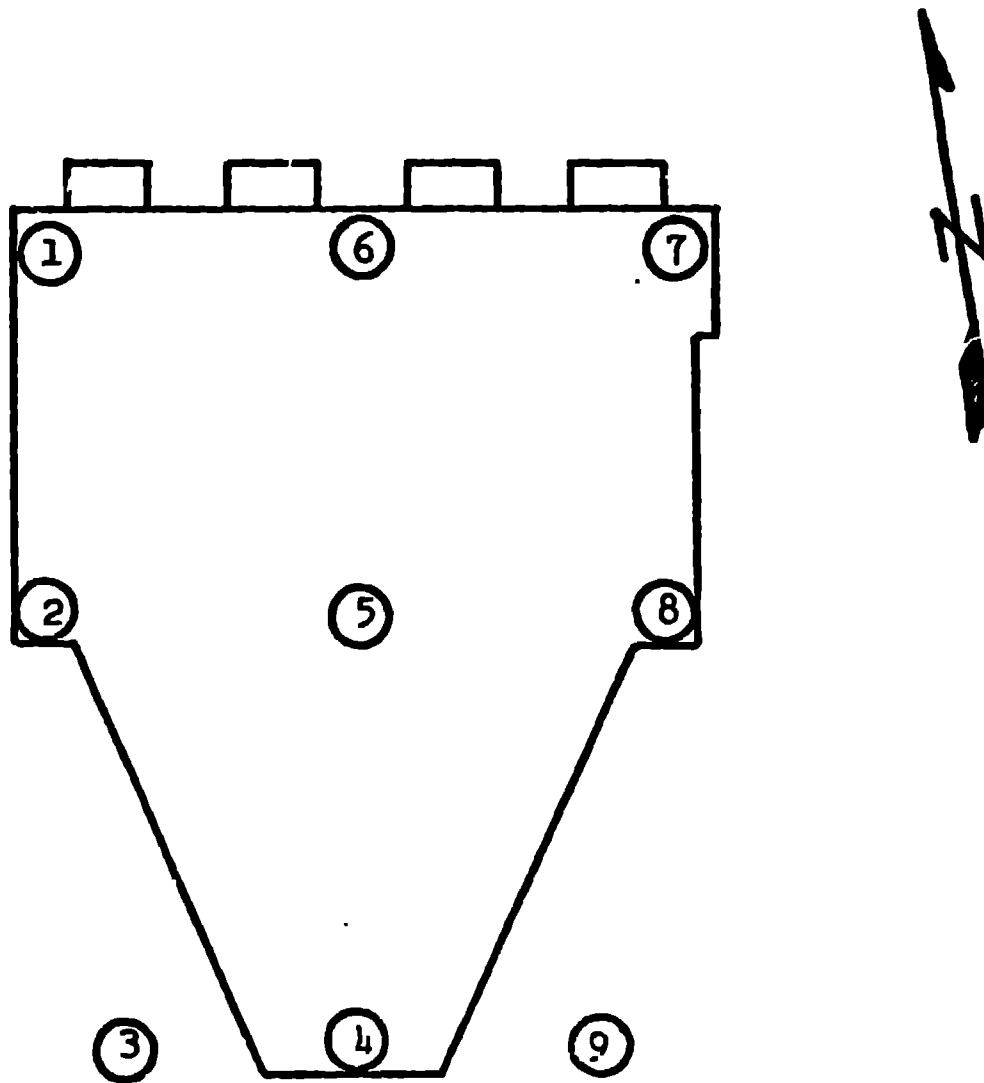

**Fig. 38 LOCATIONS OF SOIL SAMPLES TAKEN FROM CLEARED SITE**

were made on all the samples by leaching the samples with acid and analyzing the leachate. The gross alpha concentrations were used to select samples for plutonium analyses which would include the maximum and minimum gross alpha concentrations and several concentrations within the range. The plutonium data are shown in Table 6.

#### 9. Final Site Condition

The 2 metre depression was filled with soil that was available from a previous excavation of a trench located approximately 300 metres due east of the Building 12 site. A composite sample of this fill dirt contained  $0.03 \pm 0.01$  pCi/g  $^{238}\text{Pu}$  and  $1.3 \pm 0.1$  pCi/g  $^{239}\text{Pu}$ . The site was graded to its original natural contour and the area was seeded with native grasses. The site, after grading and seeding, is shown in Fig. 33.

**TABLE 6** **PLUTONIUM IN SOIL SAMPLES**  
**TAKEN FROM CLEARED SITE**

<u>Sampling Station<sup>a/</sup></u> <u>and Depth from surface</u>	<u><sup>238</sup>Pu</u> <u>pCi/gm</u>	<u><sup>239</sup>Pu</u> <u>pCi/gm</u>
1 ( 0 - 20.9 cm)	0.3 ± 0.08	25.7 ± 1.1
2 ( 0 - 14.0 cm)	-	-
3 ( 0 - 22.2 cm)	-	-
4 ( 0 - 2.5 cm)	0.4 ± 0.07	28.9 ± 1.2
( 2.5- 7.6 cm)	-	-
( 7.6- 22.8 cm)	-	-
5 ( 0 - 2.5 cm)	-	-
( 2.5- 7.6 cm)	0.6 ± 0.1	42.5 ± 1.5
( 7.6- 12.7 cm)	0.7 ± 0.1	70.0 ± 2.5
( 12.7- 33.0 cm)	0.02 ± 0.01	4.3 ± 0.2
6 ( 0 - 2.5 cm)	-	-
( 2.5- 7.6 cm)	-	-
( 7.6- 15.2 cm)	0.3 ± 0.04	30.8 ± 1.1
7 ( 0 - 16.5 cm)	-	-
8 ( 0 - 16.5 cm)	-	-
9 ( 0 - 17.8 cm)	0.4 ± 0.08	50.7 ± 2.3
Fill dirt	0.03 ± 0.01	1.3 ± 0.1

<sup>a/</sup> See Fig. 38 for location.



## **List of Figures**

<b><u>Figure Number</u></b>	<b><u>Title</u></b>
<b>1.</b>	<b>Site Plan for Plutonium Processing Facility</b>
<b>2.</b>	<b>View of Plutonium Processing Facility</b>
<b>3.</b>	<b>Floor Plan of Building 12</b>
<b>4.</b>	<b>Side View of Building 12</b>
<b>5.</b>	<b>Side View of Filter and Blower Area</b>
<b>6.</b>	<b>Front View of Building 12</b>
<b>7.</b>	<b>Preparing to Remove Stack Number One</b>
<b>8.</b>	<b>Blower Room After Removal of Stacks Number 1, 2 and 3</b>
<b>9.</b>	<b>View of Filter Banks in 1945</b>
<b>10.</b>	<b>Precipitron Frame Being Rolled onto Plastic Sheeting</b>
<b>11.</b>	<b>Precipitron Frame Being Wrapped in Plastic Ready for Loading</b>
<b>12.</b>	<b>Precipitron Frame Ready for Hauling to Disposal Site</b>
<b>13.</b>	<b>Details of Roof Construction</b>
<b>14.</b>	<b>Details of Wall and Floor Construction</b>
<b>15.</b>	<b>Intake Plenum After Stripping and Painting</b>
<b>16.</b>	<b>Precipitron and Filter Area After Stripping and Painting</b>

<u>Figure Number</u>	<u>Title</u>
17.	Interior of Penthouse Area After Stripping and Painting
18.	Building 12 After Corrugated Siding Had Been Removed from Intake Plenum Wall
19.	Ground Level View Penthouse Area After Removal of Most of the Walls and Roof
20.	Roof Level View of Penthouse Area, After Removal of Most of the Walls and Roof
21.	Intake Plenum After East Wall Had Been Pulled Down
22.	Foundation for Intake Plenum Area
23.	Removal of Intake Plenum Floor
24.	Precipitron and Filter Area After Blower Room and Intake Plenum Had Been Removed
25.	Appearance of Structural Steel After the Attempt to Pull Down Individual Pieces
26.	Cutting Steel Beams with Welding Torch
27.	Loading Steel Beams Onto Truck for Disposal
28.	Precipitron Area When Most of the Steel Had Been Removed
29.	Bulldozer Removing Concrete Floor in Precipitron Area
30.	Part of Concrete Foundation
31.	Removing the Last Concrete and Dirt
32.	Removing Drain Line

**Figure Number**

**Title**

- |            |   |
|------------|---|
| <b>33.</b> | <b>View of Site After Completion of Demolition</b>              |
| <b>34.</b> | <b>Worker Suited Up for Demolition Work</b>                     |
| <b>35.</b> | <b>Location of Demolition Site and Air Sampling Stations</b>    |
| <b>36.</b> | <b>Location of Special Air Sampling Stations</b>                |
| <b>37.</b> | <b>Locations of Soil Samples Taken from Under Intake Plenum</b> |
| <b>38.</b> | <b>Locations of Soil Samples Taken from Cleared Site</b>        |

### **List of Tables**

- 1. Legend for Fig. 3.**
- 2. Departments Represented on Demolition Committee**
- 3. General Surveillance Monitoring Results**
- 4. On-Site (TA-21) Gross Alpha Concentrations in Air**
- 5. Gross Alpha Concentrations of Soil Samples Collected under Intake Plenum**
- 6. Plutonium in Soil Samples Taken from Cleared Site**