

CIC-14 REPORT COLLECTION  
**REPRODUCTION  
COPY**

LA-2234 (Rev)

**c. 3**

An Integral Experiment to Measure  
the Tritium Production from  ${}^7\text{Li}$  by 14-MeV  
Neutrons in a Lithium Deuteride Sphere



**los alamos**  
**scientific laboratory**  
of the University of California  
LOS ALAMOS, NEW MEXICO 87544

UNITED STATES  
ATOMIC ENERGY COMMISSION  
CONTRACT W-7405-ENG. 36

This report was prepared as an account of work sponsored by the United States Government. Neither the United States nor the United States Atomic Energy Commission, nor any of their employees, nor any of their contractors, subcontractors, or their employees, makes any warranty, express or implied, or assumes any legal liability or responsibility for the accuracy, completeness or usefulness of any information, apparatus, product or process disclosed, or represents that its use would not infringe privately owned rights.

Printed in the United States of America. Available from  
National Technical Information Service  
U. S. Department of Commerce  
5285 Port Royal Road  
Springfield, Virginia 22151  
Price: Printed Copy \$3.00; Microfiche \$0.95



# An Integral Experiment to Measure the Tritium Production from ${}^7\text{Li}$ by 14-MeV Neutrons in a Lithium Deuteride Sphere

by

**Marvin E. Wyman\***

Work done by

George A. Cowan  
James S. Gilmore  
Elizabeth Graves  
Marvin E. Wyman

LOS ALAMOS NATIONAL LABORATORY



3 9338 00359 4727

\*Former LASL Staff Member. Present address: University of Illinois, Urbana, Illinois 61801.



#### PREFACE

The work described in this report was performed at Los Alamos during the period 1954-58. A classified report that included a description of this experiment was issued in 1958. Portions of this report were distributed at Los Alamos as an unclassified internal document in 1963.

Tritium production in a lithium medium has received increasing attention in connection with the design of tritium breeding blankets for conceptual thermonuclear fusion reactors. Because this experiment may be of value as an integral test<sup>9</sup> of these tritium breeding calculations, the earlier unclassified material is issued as a report intended for external distribution. No major changes have been made in the text, and the general results of the experiment appear to remain valid.

AN INTEGRAL EXPERIMENT TO MEASURE  
THE TRITIUM PRODUCTION FROM  ${}^7\text{Li}$  BY 14-MeV  
NEUTRONS IN A LITHIUM DEUTERIDE SPHERE

by

Marvin E. Wyman

ABSTRACT

A sphere of LiD 2 ft. in diameter was irradiated by  $2 \times 10^{15}$  14-MeV neutrons. Samples of  ${}^7\text{Li}$  metal were positioned at various radii for the irradiation. An analysis of these samples for tritium led to a determination of the number of tritons produced by 14-MeV neutrons acting on  ${}^7\text{Li}$  in a LiD system.

I. INTRODUCTION

R. G. Thomas of the Physics Division at LASL suggested in 1954 that the (n,t) cross section for  ${}^7\text{Li}$  might be great enough to produce measurable amounts of tritium. The author had already made an exploratory measurement of the tritium yield from  ${}^7\text{Li}$  in the fission neutron flux of the Water Boiler reactor. A value of 35 mb for the fast fission spectrum was obtained with an almost unknown reliability due to the uncertainty of the flux (determined by thermal flux and cadmium ratios for indium). It did suggest that the (n,t) cross section for  ${}^7\text{Li}$  might be a few hundred millibarns at some neutron energies below 14 MeV.

It was decided to check the cross section for tritium production by 14-MeV neutrons in  ${}^7\text{Li}$ . Four samples (~ 60 mg each) of normal lithium were sealed in gold capsules and irradiated at the LASL Group P-4 Cockcroft-Walton D-T source of 14-MeV neutrons. The distance from the capsule to the center of the neutron source was 2.3 cm. Since there were relatively few thermal neutrons at that location, no correction was made for their effect in the  ${}^6\text{Li}$ . (Actually, there was several hundred times more tritium activity from the  ${}^7\text{Li}$  than the  ${}^6\text{Li}$ .) The results gave  $310 \pm 30$  mb for the (n,t) cross section. Because measuring the cross section as a function of energy would take considerable time, an integral experiment

was proposed. By irradiating a sphere of lithium deuteride with metal  ${}^7\text{Li}$  samples located at various radii, we hoped to determine the probability for triton creation in  ${}^7\text{Li}$  per 14-MeV neutron, starting from the center of the LiD.

This report will attempt to describe this integral measurement and, by indicating the difficulties involved, to permit the reader to evaluate the results more easily.

II. EXPERIMENTAL ARRANGEMENT FOR THE IRRADIATION

A sphere of LiD (normal lithium) was obtained from the Oak Ridge Y-12 plant. It was made by cold pressing the deuteride powder to a specific gravity of approximately 0.836. Fourteen pieces were fabricated and fitted together to form a solid 30-cm sphere weighing 92.3 kg. Special straps of Dural were made to hold the pieces in two separate identical hemispheres. The hemisphere plane was milled so that the assembly could form a sphere around the Cockcroft-Walton D-T source of LASL Group P-4. Holes were drilled radially in the sphere at the 90° plane to the deuteron beam so that small samples and foils could be positioned at various radii in the sphere. Plugs of LiD were made to fill these holes once the samples were in position so that a maximum of LiD existed as environment. Twenty-four samples of  ${}^7\text{Li}$  metal (99.9% isotope prepared by Oak Ridge

National Laboratory) were sealed in copper capsules and positioned at 12 different radii (2.5 to 30 cm) in the sphere.

Eight packets of six (n,2n) threshold detectors were made up and located at eight different radii. These detectors included the following with the indicated approximate threshold: Sc (11.2 MeV), Ni (11.8 MeV), As (10.3 MeV), Rh (9.35 MeV), Ge (11.6 MeV), and Tl (8.8 MeV). Included with these packets of six (n,2n) detectors were  $^{238}\text{U}$  foils. These foils are useful not only as (n,2n) detectors, but also for counting total fissions (thereby being a lower threshold detector). In addition, some Sc and  $^{238}\text{U}$  foils were positioned in front and back of six of the  $^7\text{Li}$  capsules to determine whether there was any noticeable flux perturbation by the capsules or holes in the LiD.

A sketch of the 90° plane of the sphere is shown in Fig. 1. Figures 2 through 4 show photographs of the sphere, provision for loading of samples, and method of suspension about the D-T Cockcroft-Walton source.

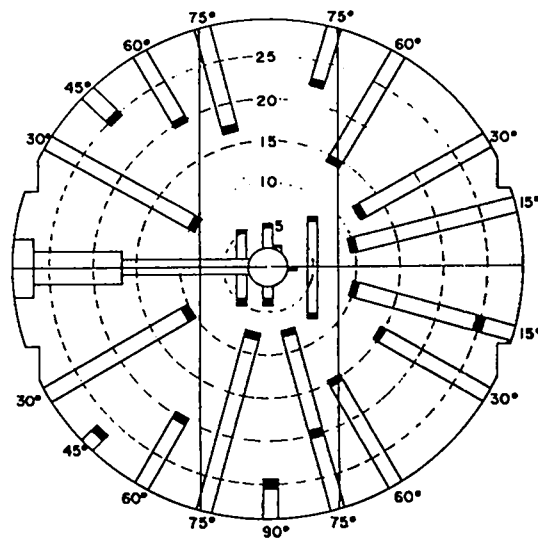

Fig. 1. Diagram of the 90° plane of the sphere showing the sample locations.

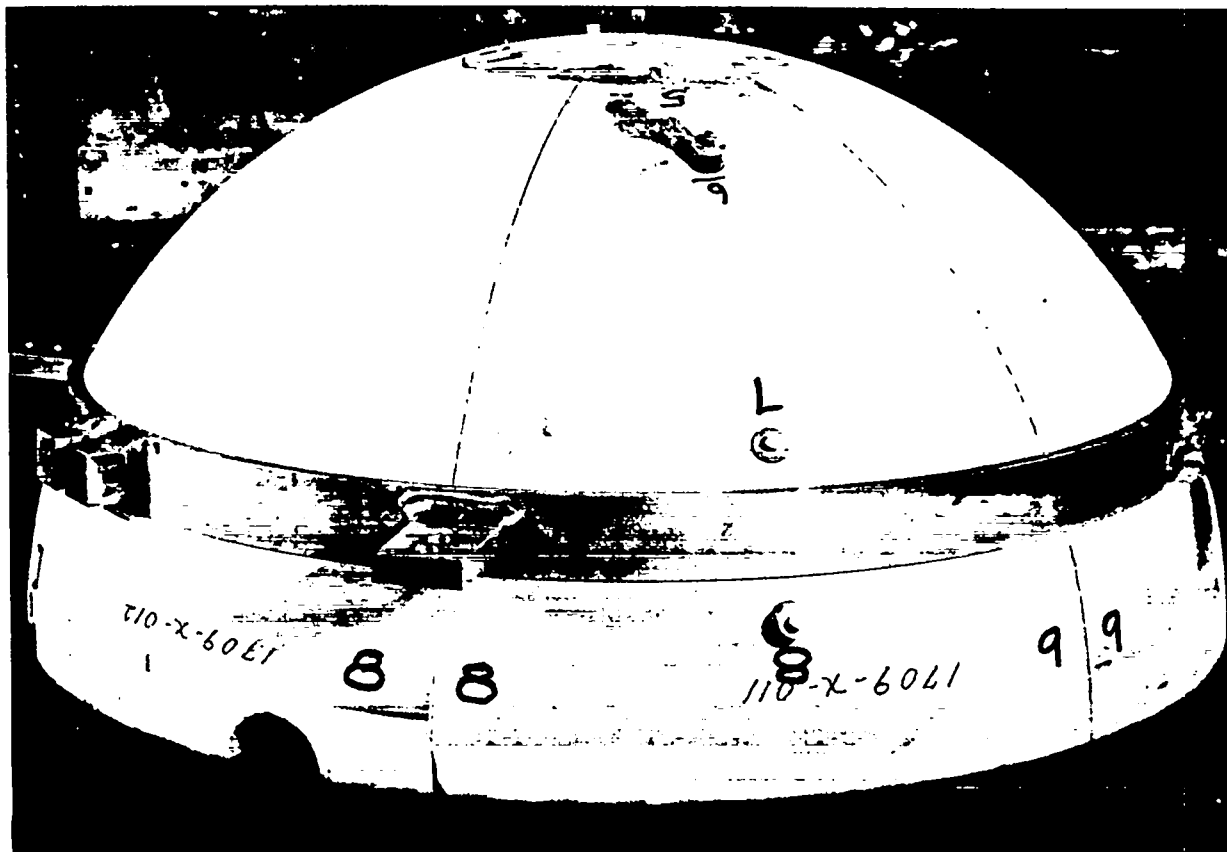

Fig. 2. Photograph of hemisphere of normal LiD showing how pieces were strapped together.

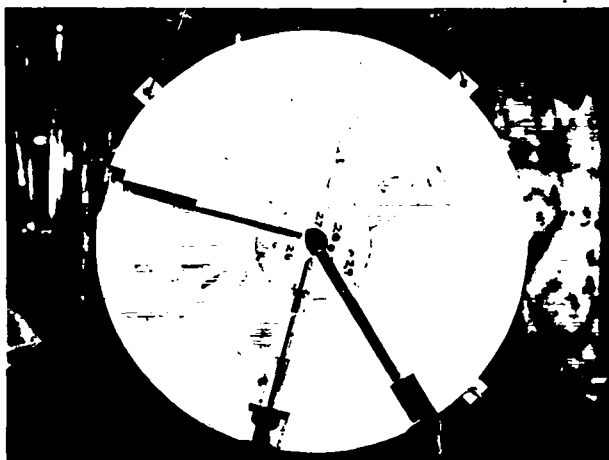

Fig. 3. Photograph of hemisphere of normal LiD showing how parting plane was milled to allow assembly over the P-4 Cockcroft-Walton source.

The sphere was irradiated by  $2 \times 10^{15}$  neutrons (requiring 20 h of continuous operation of the P-4 Cockcroft-Walton generator). Deuterons of 240 keV were accelerated into a tritium-loaded zirconium target. The neutrons in the  $90^\circ$  plane to the deuteron beam are essentially pure 14.1-MeV neutrons. The neutron beam intensity is of such a distribution that the total neutrons produced divided by  $4\pi R^2$  will give the  $90^\circ$  yield. The neutron flux in the forward direction is approximately 5% greater than this and the backward neutron flux is about 5% less.

The sphere transmission was measured by Elizabeth Graves with a long counter and also with a stilbene crystal spectrometer. An attempt was made to look at the transmitted flux by photographic techniques. The tritium was thermally evolved from the capsules containing  $^7\text{Li}$  and its beta activity determined by absolute counting in a proportional counter. The identity of the tritium was verified by using a palladium valve system.

### III. TRITIUM ANALYSIS TECHNIQUE

Lithium metal is very reactive with most materials at elevated temperatures ( $>200^\circ\text{C}$ ) and with some materials at room temperature (water and nitrogen, for example). To maintain the lithium in the metal state for the irradiation, copper capsules, approximately 1.2 cm i.d. and about 1.0 cm high, were filled by cutting the raw lithium metal and pressing it into the capsules in a helium atmosphere. The capsules were then sealed shut with solder. The weight of

the lithium sample was determined by weighing the capsule and solder before loading and subtracting from the final loaded weight. Care was required in preventing the molten solder from reaching the lithium since they react quite violently. A few turns of nichrome wire surrounding the capsule sufficed as a heat source for the soldering operation. Six capsules used for the close-in positions (2.5, 5.0, and 7.5 cm) were of a smaller size, approximately 0.6 cm i.d. and about 0.5 cm high. The larger capsules contained about 0.4 g lithium metal while the smaller capsules contained about 0.060 g.

The technique for measuring the tritium yield depended on its beta activity. This activity has a  $12.262 \pm 0.004$  year half-life<sup>1</sup> and a maximum energy of about 18.0 keV.<sup>2</sup> An ethane-filled proportional counter was used and the evolved tritium added to the counter filling. The counter was a 1-1/4 in. i.d. copper tube about 14 in. long. One-half inch bronze bolts were drilled out and Stufekoff seals soldered on the bolts. These end seals could be bolted on the copper end plates of the counter. The counter was strung with 0.002-in. platinum wire. The counter was operated with ethane at 20 cm and gave a voltage plateau of about 300 V (at approximately 2100 V). The flatness of the plateau was achieved by modifying the Model 101 amplifier so that it could be saturated to approximately 30 times normal and by limiting the output pulse to about 120 V.

To reduce background, an annular ring counter was made. It was about 3-1/2 in. o.d., about 15 in. long, and made of copper. The same type of end seals were used and it was strung with ten 0.003-in. Kovar wires. It was operated as a proportional counter with ethane at 20 cm. Figure 5 shows a sketch of the ring and center counters.

The two counters were surrounded by 3 in. of steel on all sides, 8 in. of lead above, 4 in. of lead on the sides, and 2 in. of lead on the bottom. The entire shield weighed approximately 2 tons. In this shield the ring counter had a counting rate of about 450 counts/min and the center counter about 150 counts/min. When the counters were used in anti-coincidence, one got a net counting rate of about 30 counts/min for the center counter. A replacement center counter gave a net background rate of 15 counts/min. Figure 6 shows schematically the arrangement of the electronics.

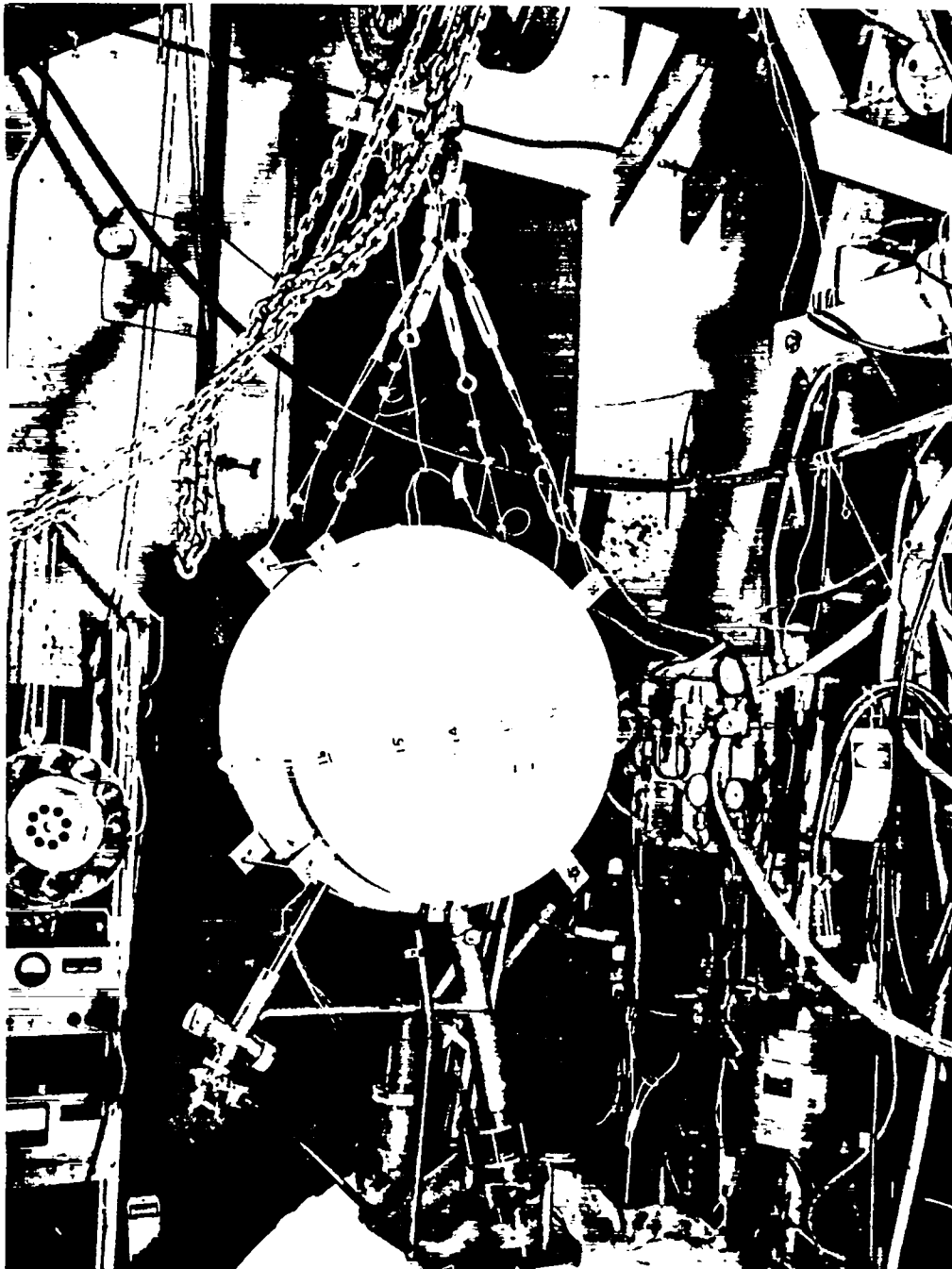

Fig. 4. Photograph of LiD sphere as suspended over the Cockcroft-Walton source. The numbers indicate radial openings into the sphere from the outside where samples were located.



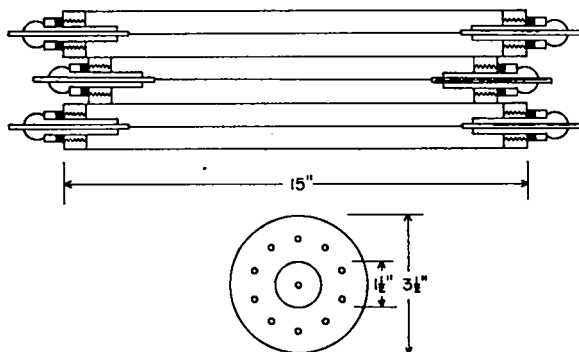

Fig. 5. Tritium analysis counter and the annular anticoincidence counter.

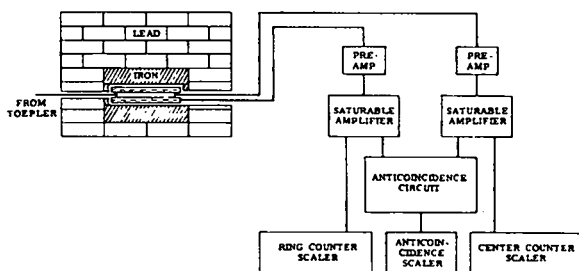

Fig. 6. Electronic system for the analysis of tritium.

The calibration of the counter depended on a counter whose efficiency was known. This calibration counter was made with Lucite end plugs to minimize the end losses (due to field distortion).<sup>3,4</sup> It was 97% efficient for low-energy betas such as those from  $^{14}\text{C}$  and tritium. The counter used in the sphere analysis was 86% efficient.

Normal procedure was to evolve the tritium from the sample, and by use of a Toepler pump, put it into the counter containing the ethane. The activity was determined by measuring the plateau and subtracting the background. To verify the activity as that from tritium, a palladium valve circuit was installed. Figure 7 shows schematically the arrangement. The sample was taken from the counter using the hand Toepler and put into the cycling line which contains a liquid nitrogen trap. The trap condensed all the ethane, leaving only the tritium (and hydrogen carrier) to pass over the palladium, which was heated to about  $500^\circ\text{C}$ . The counter was then refilled and the background measured. The hand Toepler was connected to the other side of the palladium to collect any tritium that had passed through. It was then added to the counter filling, and one can verify if the original activity was all tritium. In this ex-

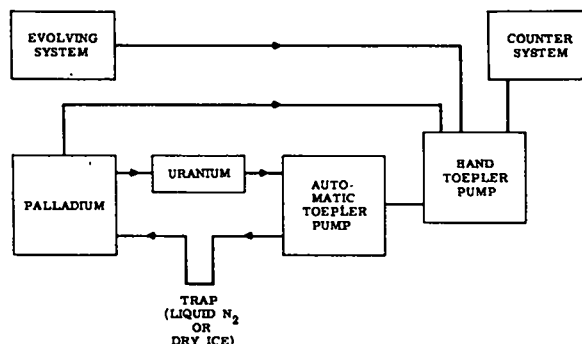

Fig. 7. Schematic of the tritium analysis line.

periment it was easily shown that all activity evolved from a capsule was that of tritium. Figure 8 shows a picture of the system.

The process of extracting the tritium from the capsules caused the most difficulty. It was thought that heating the capsules in a quartz tube sealed to the vacuum system would work. However, the lithium reacted with quartz and destroyed the firing tubes if the temperature was raised above the range of approximately  $650$  to  $700^\circ\text{C}$ . It was observed that one could release the tritium from lithium by letting the lithium combine with lead or tin (some of which was available due to the solder). One gram of lead was included in the capsule loadings, with the hope that when the lithium and lead melted, they would form a lithium-lead compound and release the tritium, which probably existed as  $\text{LiT}$ . This method worked and one was able to evolve the activity at about  $400^\circ\text{C}$ . The small samples were handled successfully this way, but the large samples caused difficulty. At the time the lead and lithium combined, there was enough energy released to cause a rather severe mechanical shock and two samples were lost. This was partially remedied by using an inner quartz tube and a copper tube (containing the sample) inverted inside it. However, enough lithium seemed to react with the quartz so that upon cooling there was a sizable probability of cracking the quartz tube (due to the difference in thermal expansion of the quartz and the lithium-quartz compound). Since it seemed desirable to re-evolve the samples to show that all the tritium was liberated, a more dependable system was sought.

It was observed that lithium did not seem to react perceptibly with steel at  $1000^\circ\text{C}$ , so several steel tubes were made up for use in the tritium evolution. The tubes were made by drilling out 1 in.

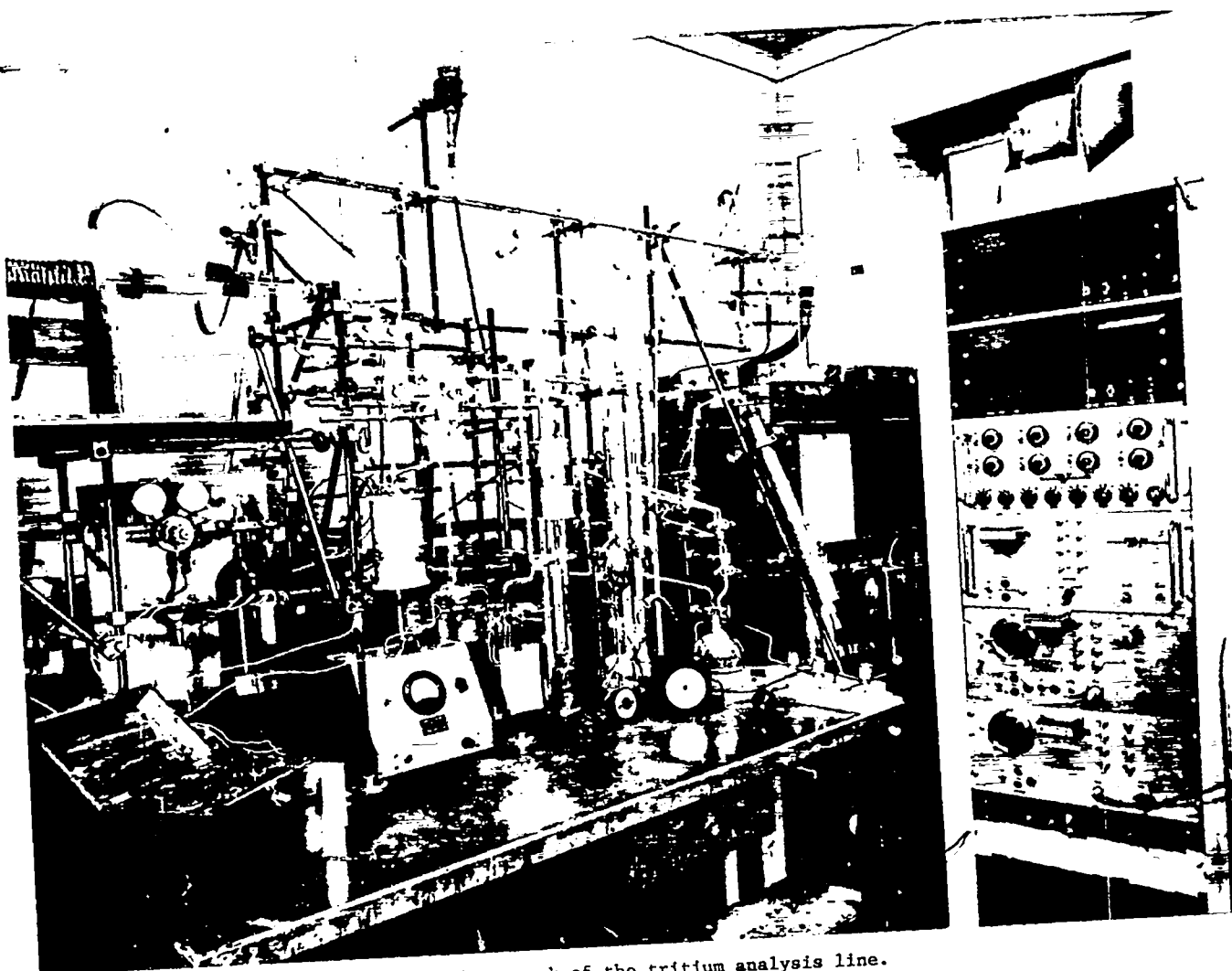

Fig. 8. Photograph of the tritium analysis line.

mild steel rods 12 in. long to a depth of 11.5 in. One-half inch copper tubing (1/32-in. wall) was cut to about 6-in. lengths, and copper end plates were silver-soldered over one end. The capsules were inserted in the copper tubes, which were put into the steel tubes open end first. The assembly was waxed onto the vacuum line using Apiezon W. A water jacket for cooling was placed over the steel tube between the furnace and the wax joint.

It was discovered that the  $^7\text{Li}$  used in the first irradiation was contaminated with tritium and was producing inconsistent and unreliable results. The quartz system mentioned above was in use when this was observed. New  $^7\text{Li}$  was obtained from ORNL and found to be essentially free of tritium. New capsules were loaded without lead and the LiD sphere again irradiated. It was during the interval be-

tween irradiations that the steel system was put into use.

Initially, the steel system appeared to work quite well, except that it seemed to evolve the activity at a higher temperature than the quartz system did. This was not thought unusual at first since one would expect to have to go to temperatures above the LiH decomposition point (about 650 to 700°C). Most of the activity seemed to evolve at about 900°C. It was found that this system was not suitable, but not until 10 capsules of the second irradiation has been evolved. At the moment when the melting solder allowed the capsule to open, solder and lithium reacted exothermally and most of the tritium was evolved. Steel, however, has a high solution rate for hydrogen at this temperature. It requires about 900°C or higher temperatures to degas the steel. Although the

furnace temperature was raised above this point, only about two-thirds of the steel tube was at this temperature. The remainder of the tube varied from furnace temperature to room temperature. As a result it was impossible to remove all the tritium from the steel even though it had been released from the lithium. Normally, when a sample was "finished" as far as the evolution was concerned, it was cooled in a vacuum to room temperature and atmospheric air added. Lithium metal exposed to air forms LiN and LiOH. One of the steel tubes used in this way was enclosed in quartz, evacuated, and heated above the steel degassing temperature. It released about one-third as much tritium as had been originally collected. It was difficult to do this quantitatively since the amount of nitrogen and water vapor liberated at the same time is equal to twice the counter filling for the smallest samples and 15 times as great for the larger samples.

A new evolution system, which is sketched in Fig. 9, was developed. A sample is enclosed in a small steel cylinder about 1 in. long and 5/8 in. in diameter. It is a sleeve with steel disks loosely crimped onto the ends. This confines the lithium-solder reaction and still allows the gas to evolve. The steel sleeve system rests on a 2-mm quartz rod frame, which in turn is inserted into a 20-mm quartz tube 6 in. long. This tube is surrounded by an 8 in. long 24-mm quartz tube closed at one end. The whole assembly is placed in an 18-in. quartz tube (28-mm o.d.) which is the vacuum jacket and is waxed onto the line. A water jacket surrounds the vacuum jacket and an induction furnace coil of some 20 turns of 3/16-in copper tubing is used as the source of heat energy.

The steel sleeve actually acts as the heat radiator since it absorbs more of the induction furnace power. The two inner quartz sleeves or tubes become coated with lithium when it vaporizes and, since they get rather warm, react with the lithium. The outer quartz tube is normally free from the lithium and is kept at the water temperature; hence it is prevented from reacting noticeably with the lithium.

All succeeding capsules were evolved in this system (temperatures of about 1100 to 1200°C being used). Upon completion of the induction evolution, the water jacket and induction coils were removed and an electric muffler furnace slid over the tube.

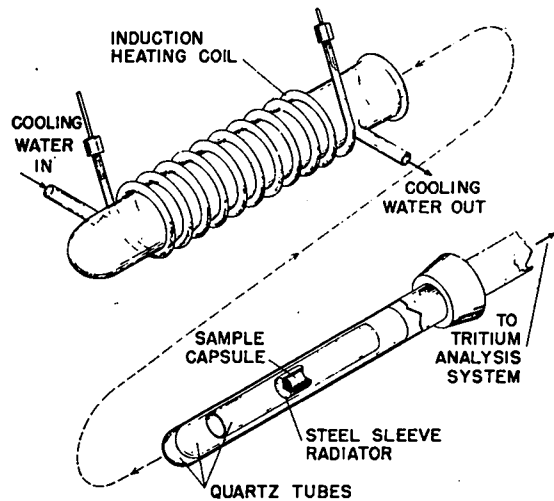

Fig. 9. Multilayered quartz evolution system.

It was then heated to about 1100°C. The second evolution rarely yielded as much as 10% of the amount obtained from the induction evolution.

#### IV. RESULTS

If  $X$  is the number of tritons formed in a small sample of  $N$  atoms of  ${}^7\text{Li}$  by  $Q$  14-MeV neutrons starting at the center of the sphere,  $X/(NQ) = P_R$  (the probability of creating tritons per  ${}^7\text{Li}$  atom per 14-MeV neutron). We really want to know the integral probability for an infinite sphere of  ${}^7\text{Li}$ . This integral is

$$\int_{R=0}^{\infty} P_R \rho 4\pi R^2 dR,$$

where  $\rho$  is the number of  ${}^7\text{Li}$  nuclei per cubic centimeter. Since  $\rho$  is generally a constant for any system, the integral involves a variable  $f(R) = P_R 4\pi R^2$ . In all the graphs  $f(R)$  is plotted as an ordinate against  $R$  as the abscissa. It is called the probability of triton formation times  $4\pi R^2$ . If  $Q/4\pi R^2$  were the flux (which is not unreasonable near the center of the sphere),  $f(R)$  becomes the average cross section for triton formation for that spectrum.

Nineteen samples of  ${}^7\text{Li}$  from the first irradiation of the sphere could be analyzed. Fifteen of these were analyzed by the final induction and furnace heating system after the second irradiation had been analyzed. Since the  ${}^7\text{Li}$  metal used for the samples had a variable amount of tritium contamination, the results would at first glance appear to be

meaningless. All samples were evolved in a quartz system, however, and should have given good results if there had been no contamination.

The samples located at 2.5, 5.0, and 7.5 had ~ 0.060 g of  $^7\text{Li}$  and gave counting rates between 1000 and 20,000 counts/min. The other samples contained ~ 0.4 g of  $^7\text{Li}$  and gave counting rates of 100 to 4000 counts/min. Figure 10 shows a plot of  $f(R)$  as measured by these samples. The hatching drawn on this figure should represent the upper limit for  $f(R)$  at any  $R$ .

Twenty samples of  $^7\text{Li}$  were analyzed from the second irradiation of the sphere. Unfortunately, nine of these were evolved in the steel tubes which did not permit complete extraction of the tritium. As a result, the nine samples should give answers for  $f(R)$  which are lower than those one would get in a quartz system. The results for  $f(R)$  as determined by these 20 samples are shown in Fig. 11. The points which have arrows on them are the samples analyzed in the steel tubes.

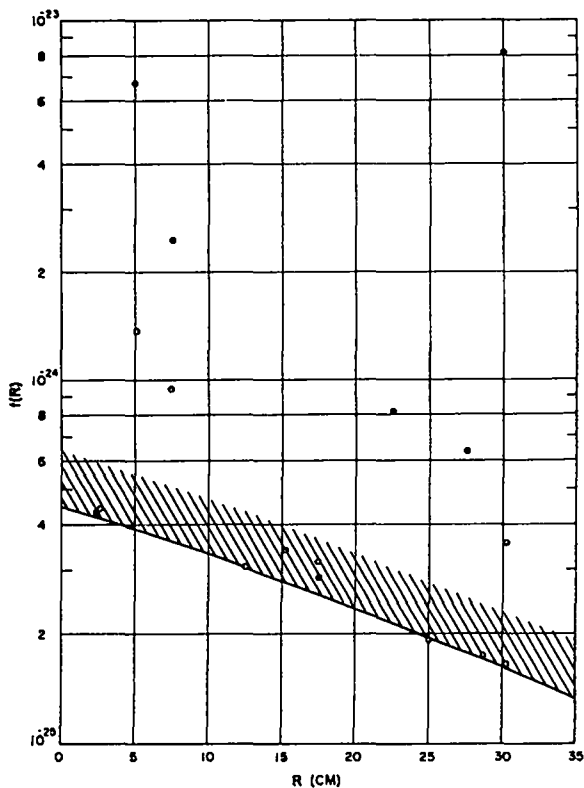

Fig. 10. Plot of  $f(R)$ , the probability of triton formation in  $^7\text{Li}$  times  $4\pi R^2$ , as a function of  $R$  for the first irradiation of the LiD sphere. The hatching drawn on this figure should represent the upper limit for  $f(R)$  at any  $R$ .

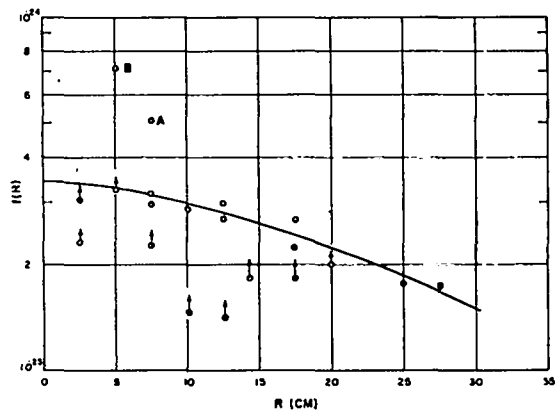

Fig. 11. Plot of  $f(R)$  as a function of  $R$  for the second irradiation of the LiD sphere.

The four samples at 2.5 and 5.0 cm and two of the samples at 7.5 cm contained ~ 0.060 g of  $^7\text{Li}$  and gave counting rates of 500 to 4000 counts/min. The other samples contained about 0.4 g of  $^7\text{Li}$  and gave counting rates of 140 to 4000 counts/min. The smooth curve which is drawn through the points represents a reasonable fit to the data. Two samples gave inconsistent results. They are labelled A and B on Fig. 11. Both of these samples were of the smaller type and hence are subject to greater errors in weighing. Fortunately, at the 7.5-cm position (Sample A), two larger samples were analyzed correctly and gave essentially the same result. The curve was drawn through the weighted average of all three samples. The result from Sample B is not explained. It was the first sample analyzed after the evolution system was changed from the steel firing tubes system to the final quartz system. Though unexplained, it was disregarded in drawing the smooth curve.

These results (Figs. 10 and 11) have not been corrected for any tritium created by low-energy neutrons reacting with the small amount of  $^6\text{Li}$  contained in the  $^7\text{Li}$  (~ 0.08%).<sup>5</sup> Six samples of normal lithium (~ 0.4 g) were positioned at various radii in the sphere during each irradiation. Two of these were lost during analysis, and two from the second irradiation were analyzed using the steel firing tubes. The eight remaining samples were analyzed by the quartz induction and furnace heating system. These data are shown in Fig. 12 (the points with arrows being the samples analyzed with the steel tubes). The smooth curve as drawn is probably a reasonable one.

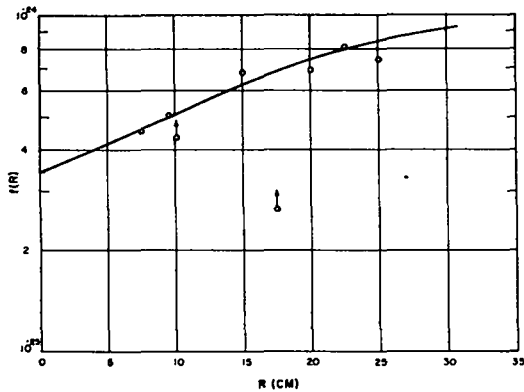

Fig. 12. Plot of  $f(R)$  as a function of  $R$  for the normal lithium samples. Both irradiations of the LiD sphere are included. The results are computed as if only  ${}^7\text{Li}$  caused triton formation. That is, the number of tritons produced is divided by the number of  ${}^7\text{Li}$  atoms present in the natural lithium sample.

Since there is about 100 times as much  ${}^6\text{Li}$  in normal lithium as in the enriched  ${}^7\text{Li}$ , one can correct the curves of Fig. 10 and Fig. 11 with reasonable accuracy. The correction lowers the curve by varying amounts, from no correction at  $R = 0$  to 4.3% at  $R = 30$  cm.

The two curves for  $f(R)$  as a function of  $R$  have been corrected and redrawn in Fig. 13. If one assumes that a sphere of  ${}^7\text{LiD}$  would have the same neutron flux and spectrum as a normal LiD sphere, one can use  $\rho = 5.625 \times 10^{22}$   ${}^7\text{Li}$  atoms/cm<sup>3</sup> and obtain

$$\rho \int_{R=0}^{30 \text{ cm}} f(R) dR = 0.43 \text{ tritons/14-MeV neutron}.$$

Using the upper curve, one gets 0.48 tritons/14-MeV neutron.

#### V. EXTRAPOLATION OF RESULTS TO AN INFINITELY LARGE SYSTEM

In order that these results might be extended to infinite systems, a rather crude theory was set up. The source of neutrons at the center of the sphere consists of 14.1-MeV neutrons. These neutrons interact with the LiD elastically and inelastically, producing a degraded neutron spectrum out in the main body of the sphere. The detailed properties of the various interactions are not known so the following

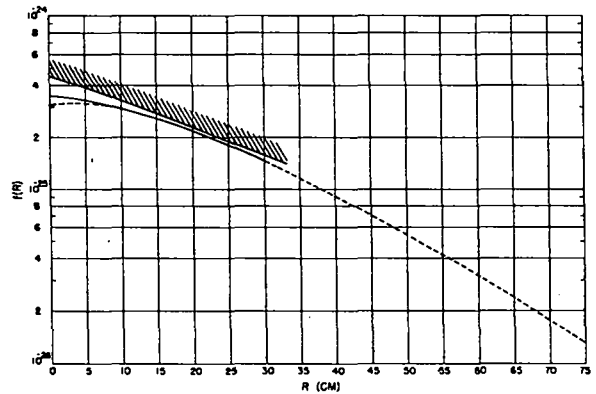

Fig. 13. Plot of  $f(R)$  as a function of  $R$  corrected for the  ${}^6\text{Li}$  content. The upper solid curve is the upper limit as measured by the first irradiation. The lower solid curve represents the results obtained from the second irradiation. The dotted curve is a theoretical estimate used to extrapolate to the case of an infinite sphere.

simplifying assumptions are made. Three neutron energy groups will be considered:

Group A: 11 MeV to 14 MeV

Group B: 8 MeV to 11 MeV

Group C: 4 MeV to 8 MeV

It will be assumed that neutrons A are moved only into B (not C) and those in B into C and from C below the threshold for triton formation. It is assumed that neutrons move only in the forward direction. Further, it is assumed that the removal cross sections for these transfers are in the ratios of the total cross sections for these groups. The total neutron cross section as a function of neutron energy is shown in Fig. 14.<sup>6</sup> The values for Groups A, B, and C are shown. It will be assumed that  $\sigma_B = 1.2 \sigma_A$  and  $\sigma_C = 1.5 \sigma_A$ .

The predicted number in Group A then becomes

$$N_A = N_0 e^{-\rho \sigma_A X}.$$

If one lets  $y = \rho \sigma_A X$ , the expressions for the three groups become

$$N_A/N_0 = e^{-y}$$

$$N_B/N_0 = 5 e^{-y} - 5 e^{-1.2y}$$

$$N_C/N_0 = 3 e^{-y} - 5 e^{-1.2y} + 2 e^{-1.5y}.$$

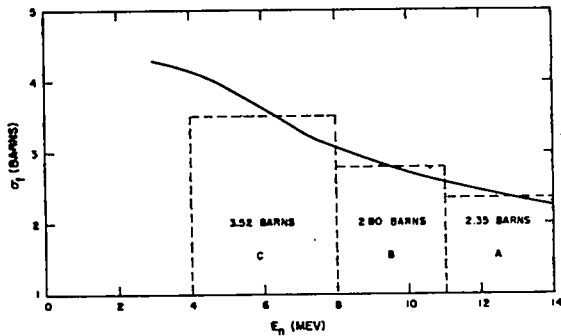

Fig. 14. Total neutron cross section as a function of neutron energy for the LiD molecule.

The cross sections for triton production for these groups are shown in Fig. 15.<sup>7,8</sup> By multiplying each group by the appropriate tritium production cross section, one gets the function  $f(y)$  which we have described. Actually, to fit the data, a value of 310 mb was used for Group A (for triton production). This is not inappropriate since the source of neutrons is a monoenergetic group of 14.1-MeV neutrons. However, one must choose a  $\sigma_A$  so that  $y$  will have a scaling factor. A value of  $\sigma_A = 1.185$  b (a relaxation length of 15 cm for Group A) was used. The result is plotted as a dotted line on Fig. 13. The fit to the experimental curve is quite good except for  $R < 7$  cm. One would expect there should be an additional small contribution in the triton production for small values of  $R$  due to neutrons scattered back through the central region. This effect decreases as one moves outward in the sphere.

At 14 MeV the total cross section is 2.25 b. The deuterium contributes 0.80 b and the lithium contributes 1.45 b. The neutron inelastic scattering

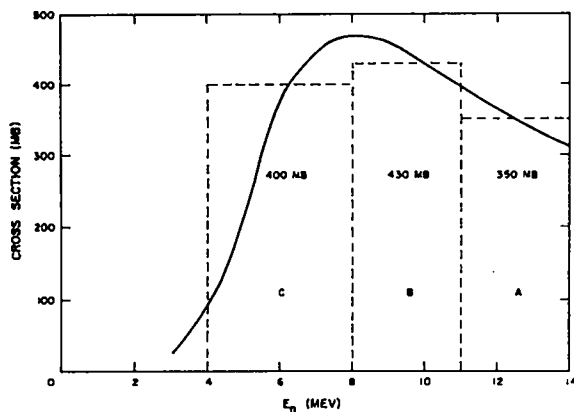

Fig. 15. The  ${}^7\text{Li}(n,n'\alpha)\text{T}$  reaction cross section as a function of neutron energy.

cross section for lithium is about 0.40 b. Of the 1.05 b elastic scattering cross section remaining, only a small amount (perhaps 0.1 b) can be considered to change a neutron from 14-MeV energy to below 11 MeV. However, some rather large part of the deuterium cross section should be included. Taking 0.7 b for deuterium and 0.4 b plus 0.1 b for lithium, one gets 1.2 b, which is about what was required.

The integral  $\rho \int_{30 \text{ cm}}^{\infty} f(R) dR$  for the theoretical

extrapolation as drawn in Fig. 13 is 0.16. If one raised the dotted curve to fit the upper limit curve more closely, the integral would have a value of 0.17.

The final results for the triton production by  ${}^7\text{Li}$  per 14-MeV neutron in both normal LiD and  ${}^7\text{LiD}$  environments, from a source at the center of a deuteride sphere, are listed in Table I. The  ${}^7\text{LiD}$  results here are obtained from the LiD results by assuming that the magnitude and spectrum of the neutron flux are the same for the two materials. A better analysis of this experiment, using modern (1972) neutron transport codes and cross sections, is discussed in Ref. 9.

TABLE I

TRITONS PER 14-MeV NEUTRON CREATED BY  ${}^7\text{Li}$  IN NORMAL LiD AND ENRICHED  ${}^7\text{LiD}$

	Normal LiD		${}^7\text{LiD}$	
	Upper Limit	Reasonable Value	Upper Limit	Reasonable Value
Sphere of $R = 30$ cm	0.445	$0.40 \pm 0.04$	0.48	$0.43 \pm 0.04$
Infinite system	0.60	$0.55 \pm 0.06$	0.65	$0.59 \pm 0.06$

## VI. RELIABILITY

The details of the difficulties have been described with the hope that the reader might be able to judge more effectively the reliability of these final results. The total number of neutrons emitted by the Cockcroft-Walton is known to  $\pm 3\%$ . Counting statistics in all cases are better than 3%. The uncertainty in the number of  ${}^7\text{Li}$  atoms in the larger samples is  $\pm 3\%$ ; in the smaller samples the uncertainty is unknown but normally should not be greater than  $\pm 10\%$ . The sample locations are known to  $\pm 1\%$ .

Subjectively evaluating all other elusive possibilities, the author suggests that  $\pm 10\%$  is not unreasonable.

#### ACKNOWLEDGMENTS

The work with the threshold detectors was handled by George A. Cowan and James S. Gilmore of LASL Group J-11 (the radiochemistry group). Elizabeth Graves measured the transmission of the sphere. The author prepared the lithium samples and made the tritium analysis.

The author would like to thank the many people who worked on various aspects of this experiment and made it possible. Max Roy arranged with Oak Ridge National Laboratory to have the sphere made. Herb Lauf and the men in the LASL hydride shop worked many hours machining the pieces and assembling them so they would fit over the Cockcroft-Walton D-T source and allow all the samples to be located at the correct radius.

Without the excellent cooperation of LASL Group P-4 the experiment would have been impossible. J. H. Coon and R. W. Davis ran the machine continuously for 20 h for each irradiation.

Acknowledgement should be made of the work done by the several other people in J-11 who worked on the analysis of the many threshold detectors.

William Schafer designed the anticoincidence counter. Two summer graduate students, H. R. Maltrud and W. Barrett, helped on the tritium analysis.

Finally, the author wishes to thank C. W. Zabel and J. M. B. Kellogg, who supplied the encouragement necessary to continue the work through the experimental difficulties involved.

#### APPENDIX A

##### RESULTS FROM RADIOCHEMICAL ANALYSES OF THE THRESHOLD DETECTORS

It was hoped that the numerous threshold detectors positioned in the sphere during the first irradiation would give some information about the neutron flux and spectrum at various radii in the sphere. After the analysis of the six threshold detectors and the uranium fission detectors, a best fit using five neutron energy groups was attempted. The results for the lower energy groups were not interpretable. However, the highest energy group (14.0 to 14.2 MeV) appeared to decrease with a relaxation length of 6.1 cm (Fig.A-1), which corresponds to a removal cross section for LiD of 2.9 b. Combining this group with the next highest group (12 to 14 MeV), we get a neutron group somewhat comparable to Group A in the simplified theory used to extrapolate the sphere results to infinity. This group appeared to decrease with a relaxation length of about 11 cm (Fig.A-1), which corresponds to a removal cross section of about 1.6 b.

Although these results seem to be inconsistent with the results indicated above and the total neutron cross section for LiD at 14 MeV which is published (2.25 b), it is hard to ignore them. The removal cross section of 1.2 b used in the theory for a group with energies from 11 to 14 MeV is considerably lower than the 1.6 b predicted by the threshold detectors. However, the total cross section at 14 MeV (2.25 b) is larger than either of these, so a somewhat higher value should be expected for a

group which is smaller (12 to 14 MeV instead of 11 to 14 MeV). It should also be noted that a detector with a threshold near 14 MeV is a rather sensitive device for getting an indication of the total cross section at that energy.

A continued study using threshold detectors for measuring a neutron spectrum in a deuteride system would seem valuable.

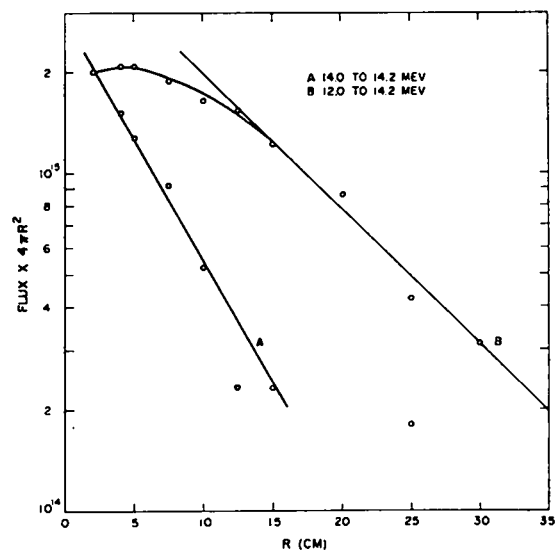

Fig. A-1. Results of Group J-11 threshold detectors. Curve A is for the neutron group 14.0 to 14.2 MeV. Curve B is for the combined neutron groups 12 to 14 MeV and 14.0 to 14.2 MeV.

APPENDIX B

TRANSMISSION MEASUREMENTS OF THE LID SPHERE

The transmission of the Lid sphere was measured with a special "long counter" and a stilbene neutron spectrometer. The long counter gave a transmission of 54% for the 30-cm-radius sphere. It should be pointed out that the counter has a fairly constant efficiency for detection of neutrons with energies between 100 keV and 14 MeV but a lower efficiency for neutrons below 100 keV.<sup>10</sup>

The results of the stilbene spectrometer are shown in Table B-1. The measured 3.1% transmission for the primary group corresponds to a total cross section of 2.05 b for that energy. This is in fair agreement with the value of 2.25 b mentioned previously. The group of neutrons with energies greater than 12 MeV showed a transmission of 15.8% which corresponds to an effective removal cross section of 1.09 b for that energy group. In the crude theory a removal cross section of 1.18 b was required for a comparable group (11 to 14 MeV). This shows rather good agreement.

A graph of the escaping neutron flux is shown in Fig. B-1.

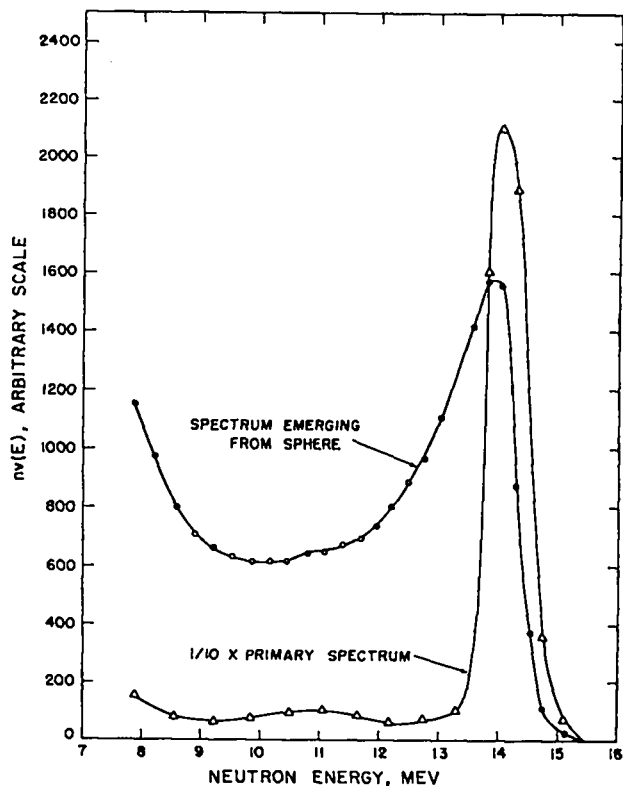

Fig. B-1. Neutron spectra in arbitrary units of neutrons per square centimeter per MeV as measured (1) for the primary bare source and (2) for the source surrounded by the large sphere.

TABLE B-1

TRANSMISSION OF THE SPHERE FOR NEUTRONS OF ENERGY GREATER THAN  $E_{th}$

$E_{th}$ (MeV)	Transmission
14.1	0.031
>12.0	0.158
>9.0	0.249
>8.0	0.264
>7.5	0.283

REFERENCES

- W. M. Jones, Phys. Rev. 100, 124 (1955).
- L. M. Langer and R. J. D. Moffat, Phys. Rev. 88, 689 (1952).
- A. G. Engelkemier, W. N. Hamill, M. G. Inghram, and W. F. Libby, Phys. Rev. 75, 1825 (1949).
- A. G. Engelkemier and W. F. Libby, Rev. Sci. Instr. 21, 550 (1950).
- Private communication from the ORNL Stable Isotopes Group, 1954.
- Donald J. Hughes and John A. Harvey, Neutron Cross Sections, Brookhaven National Laboratory report BNL-325, U. S. Government Printing Office, Washington, D. C., 1955.
- Marvin E. Wyman, Los Alamos Scientific Laboratory report LA-2235 (June 1958).
- Louis Rosen and Leona Stewart, Los Alamos Scientific Laboratory report LA-1992 (January 1956).
- D. W. Muir and M. E. Wyman, "A Tritium-Production Measurement with Application to Fusion Reactor Blanket Design," Trans. Am. Nucl. Soc., 15, 631 (1972).
- E. R. Graves and R. W. Davis, Phys. Rev. 97, 1205 (1955).

ALT:438(200)