

The Oscillating Neutrino

An introduction to neutrino masses and mixings

Richard Slansky, Stuart Raby, Terry Goldman, and Gerry Garvey as told to Necia Grant Cooper

The creator of the neutrino is testing and teasing us. Moshe Gai

We do not know . . . [if] neutrinos are massive or massless. We do not know if the potentially massive neutrinos are Majorana or Dirac, and we do not know if these neutrinos can oscillate among flavours. . . In short, there is a great deal we do not know about neutrinos. Jeremy Bernstein, 1984.

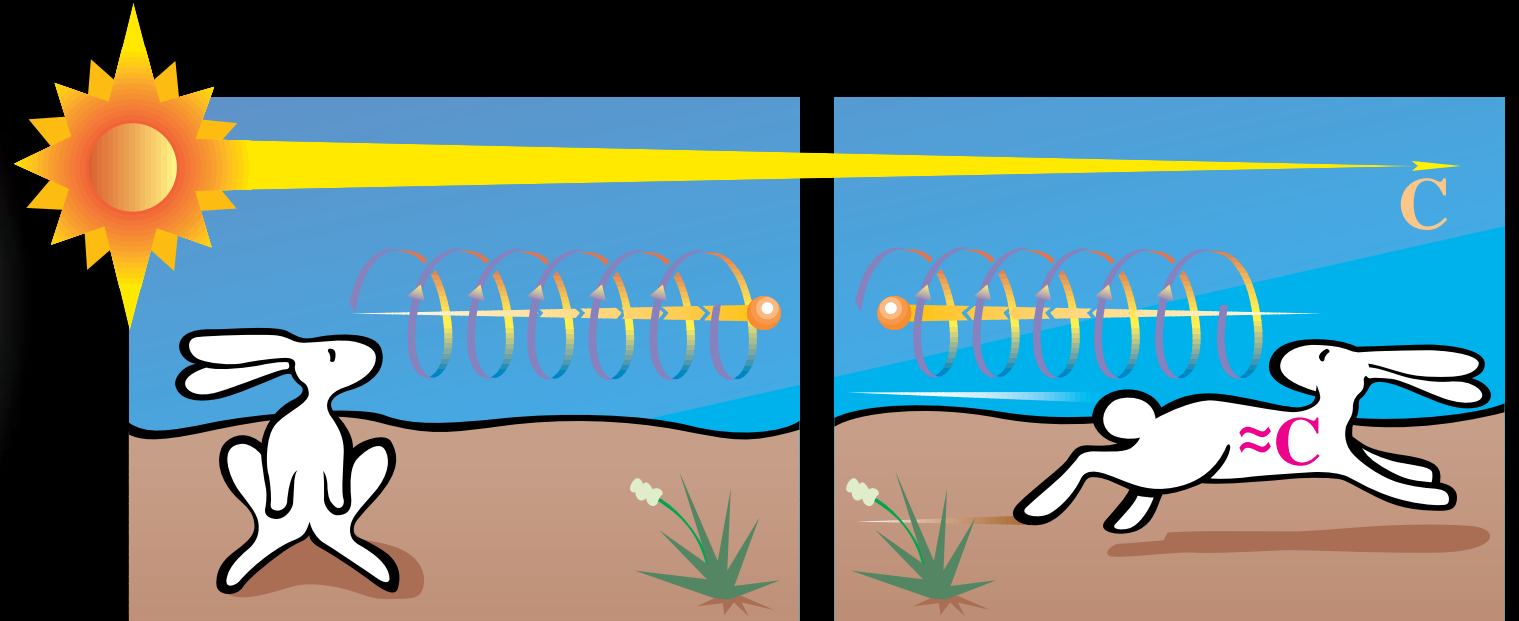

Looks left-handed.

*No—right-handed?!**

The neutrino, the theoretical construct of sixty years ago, has acquired a presence in both physics and cosmology. It is both actor and probe. It explains numerous mysteries of the observable world. Yet every new characteristic it reveals opens up more questions about its true nature.

For decades, these bits of matter have been described as massless, left-handed particles: left-handed because they were always “spinning” counterclockwise in the manner of a left-handed corkscrew. But new evidence implies that neutrinos have very tiny masses and can spin in either direction. Remarkably, the new data also suggest that neutrinos might oscillate, or periodically present themselves as one of several different types.

The primer that follows explains why this strange behavior would fit in with theoretical expectations and how oscillations could reveal neutrino masses no matter how small. It also introduces questions that will become relevant. Why are neutrino masses so small? Do the very light neutrinos have very heavy relatives that make their masses small and give us hints of the new physics predicted by the Grand Unified Theories? Are neutrinos their own antiparticles? Do neutrinos have very light sterile relatives that provide a hiding place from all interactions? Physicists continue to chase after neutrinos, and every time these ghostly particles are caught, they seem to point toward new challenges and new possibilities.

**This neutrino must have mass.*

After Reines and Cowan detected the neutrino in the late 1950s, particle physics went through a spectacular flowering that culminated in the formulation of the Standard Model. This model incorporates all that is known about the subatomic world. It identifies the most elementary constituents of matter, the elusive neutrino being among them, and then describes all the ways in which these elementary constituents can interact with and transform among each other. In its scope, this theory provides a consistent picture of every realm of the physical world: from the hot, dense early universe resulting from the Big Bang to the thermonuclear furnace at the center of the Sun, from phenomena at the smallest, subatomic distance scales accessible at particle accelerators to those at the farthest reaches visible through the Hubble telescope. The same forces and symmetries and the same set of elementary building blocks seem sufficient to describe the underlying physics of all phenomena observed so far.

But for over two decades, ever since the Standard Model was initially formulated, expectations of “physics beyond the Standard Model” have been almost palpable among those familiar with the model’s details: The theory just has far too many arbitrary parameters and mysterious relationships to be the final one. Now, after many years of searching, the first hard evidence for new physics may be at hand. The new physics—nonzero neutrino masses and mixing” among the neutrinos from different families—has long been anticipated because it parallels the behavior seen among quarks. But still, it is quite exciting because it both confirms the central concepts of the Standard Model and appears to point toward the most popular extensions, the Grand Unified Theories.

This article introduces the neutrino in the context of the Standard Model and explains how the new data on neutrinos relate and suggest extensions to that theory.

Neutrinos in the Standard Model

The Standard Model identifies twelve building blocks of matter (see Figure 1), six quarks and six leptons (and their respective antiparticles). The quarks are the building blocks that have fractional electric charge and interact primarily through the strong nuclear force, also called the color force. Color binds quarks together to form the proton, the neutron, all nuclei, and all the other hadrons (strongly interacting particles). The charged leptons are the building blocks that interact through the other three forces of nature (weak, electromagnetic, and gravity) but never through the strong force. As a result, leptons are never bound inside the nucleus by the strong force. The leptons include the electron, the heavier “electron-like” muon and tau, and these three particles’ neutral partners: the electron neutrino, the muon neutrino, and the tau neutrino. Among these twelve constituents, only the neutrinos are nearly or exactly massless.

Dubbed “the little neutral ones” because they have no electric charge, neutrinos interact with matter only through the weak force and gravity. Recall that the weak force creates neutrinos through beta decay (see the box “Beta Decay and the Missing Energy” on page 7). In that particular weak decay process, a neutron, either free or in a nucleus, transforms into a proton, and two leptons are created: an electron (or “beta” particle) and an electron antineutrino. More generally, the weak force is the force of transmutation, able to transform one type, or “flavor,” of quark into another or one flavor of lepton into another. It is also the “weakest” known force (apart from gravity), about a hundred million times weaker than electromagnetism at “low” energies, which means that it acts a hundred million times more slowly. For example, unstable particles decay through the weak force in times on the order of 10^{-8} second, whereas the characteristic times for electromagnetic decays and

strong decays are 10^{-16} second and 10^{-23} second, respectively.

It is precisely this lack of interaction strength that makes the neutrino so elusive. For not only does the weak force create neutrinos, often through beta decay, but it also mediates the only processes that can absorb them.

The intimate connection between the weak force and the neutrino has sometimes made their separate properties difficult to sort out. In fact, the theory that the neutrino is massless and left-handed (and the antineutrino right-handed) was invented to explain why the weak force violates the symmetry known as parity, also called right-left, or mirror, symmetry. If the weak force conserved parity, any weak process and its mirror image would be equally likely. Instead, in 1956, C. S. Wu and coworkers observed a striking asymmetry in the beta decay of cobalt-60 (see the box “Parity Nonconservation and the Two-Component Neutrino” on page 32.) The asymmetry suggested that *all* the antineutrinos emitted in the decay had right helicity,¹ that is, they were “spinning” like right-handed corkscrews (rotating clockwise around their direction of motion). But in a universe with right-left symmetry, an equal number of antineutrinos should have been spinning counterclockwise, like left-handed corkscrews. The fact that only right helicity was observed is an example of “maximal” parity violation.

¹Helicity is identical to handedness (or chirality) for massless neutrinos and nearly identical to handedness for particles traveling near the speed of light. For that reason, helicity is sometimes loosely referred to as “handedness.” For massive particles, however, the two quantities are quite different. Massive particles must exist in right- and left-helicity and in right- and left-handed states. As illustrated in the box on page 32 and the cartoon on page 29, helicity is the projection of the spin along the direction of motion. It can be measured directly, but its value depends on the frame from which it is viewed. In contrast, handedness is a relativistically invariant quantity, but it is not a constant of the motion for a free particle and cannot be measured directly. Nevertheless, handedness is the quantity that describes the properties of the weak force and of the particle states that interact through the weak force and have definite weak charges.

	First Family	Second Family	Third Family
Quarks	Up u Electric charge = $+2/3$. Protons have two up quarks; neutrons have one. Mass $\approx 3 \text{ MeV}/c^2$.	Charm c Electric charge = $+2/3$. Is heavier than the u . Mass $\approx 1,500 \text{ MeV}/c^2$.	Top t Electric charge = $+2/3$. Is heavier than the c . Mass $\approx 175,000 \text{ MeV}/c^2$.
	Down d Electric charge = $-1/3$. Protons have one down quark; neutrons have two. Mass $\approx 6 \text{ MeV}/c^2$.	Strange s Electric charge = $-1/3$. Is heavier than the d . Mass $\approx 170 \text{ MeV}/c^2$.	Bottom b Electric charge = $-1/3$. Is heavier than the s . Mass $\approx 4,500 \text{ MeV}/c^2$.
Leptons	Electron e Electric charge = -1 . Is responsible for electrical and chemical reactions. Mass = $0.511 \text{ MeV}/c^2$.	Muon μ Electric charge = -1 . Is heavier than the e . Mass = $105 \text{ MeV}/c^2$.	Tau τ Electric charge = -1 . Is heavier than the μ . Mass = $1,782 \text{ MeV}/c^2$.
	Electron Neutrino ν_e Electric charge = 0 . Is paired with electrons by the weak force. Billions fly through us every second. Mass = 0 (assumed).	Muon Neutrino ν_μ Electric charge = 0 . Is paired with muons by the weak force. Mass = 0 (assumed).	Tau Neutrino ν_τ Electric charge = 0 . Not yet seen directly. Assumed to be paired with the tau by the weak force. Mass = 0 (assumed).
Antiparticles	Anti-up \bar{u} Antidown \bar{d} Positron e^+ Electron antineutrino $\bar{\nu}_e$	Anticharm \bar{c} Antistrange \bar{s} Antimuon μ^+ Muon antineutrino $\bar{\nu}_\mu$	Antitop \bar{t} Antibottom \bar{b} Antitau τ^+ Tau antineutrino $\bar{\nu}_\tau$

Figure 1. Building Blocks of Matter in the Standard Model

The elementary building blocks of matter in the Standard Model are six quarks and six leptons, each carrying an intrinsic spin of $1/2$. The first family contains one quark pair—the up and the down—and one lepton pair—the electron and the electron neutrino. These four particles make up the ordinary matter that is found on Earth and throughout most of the immediate universe. In particular, the proton is made of the quark triplet *duu*, and the neutron is made of the quark triplet *udd*. The second and third families are also composed of one quark pair and one

lepton pair. Apart from the neutrinos, which are massless, the particles in the second and third families are more massive than their counterparts in the first family. They are also unstable and only stick around for tiny fractions of a second because the weak force allows them to decay into less massive particles. The more massive versions of the quarks and leptons are created in very high energy processes at the center of stars and galaxies, in high-energy accelerators, and at about 30 kilometers above the surface of the earth through the collision of very high energy

cosmic rays (mostly protons) with molecules in the earth’s atmosphere. The first hint that there are particles beyond the first family came in 1937 with the discovery of the muon. The top quark, the heaviest member of the third family, was not seen until 1995. And so far, the tau neutrino has not been detected directly. Nevertheless, the three families are so similar in structure that some of their members were anticipated long before they were observed. All particles have corresponding antiparticles (listed last in this figure) with opposite charge.

Parity Nonconservation and

the Massless Two-Component Neutrino

(a) Four States of a Spin-1/2 Particle

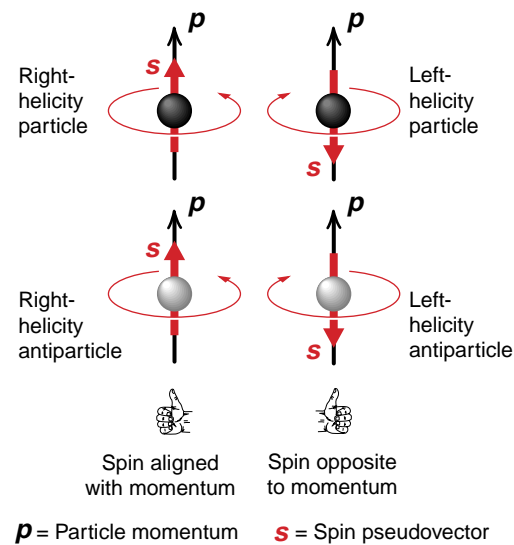

The helicity of a particle relates its intrinsic spin to its direction of motion. All quarks and leptons, including the neutrino, carry 1/2 unit of intrinsic angular momentum \mathbf{s} , or spin (measured in units of \hbar). Spin is quantized, and for a spin-1/2 particle, it has two values relative to any selected axis of quantization, which we choose to call the z-axis. The spin is often represented by a pseudovector (red arrow) that points up ($s_z = 1/2$) or down ($s_z = -1/2$) along the axis of quantization, depending on whether the particle is spinning clockwise or counterclockwise around that axis when it is viewed from below. Helicity uses the direction of motion, or the momentum \mathbf{p} , as the axis of quantization, where helicity is defined as $\lambda = \mathbf{s} \cdot \mathbf{p} / |\mathbf{p}| = \pm 1/2$.

As shown in (a), spin-1/2 particles usually have four independent states: the particle with right or left helicity and the antiparticle with right or left helicity. A particle has right helicity ($\lambda = 1/2$) if its spin and momentum point in the same direction. It has left helicity ($\lambda = -1/2$) if its spin and momentum point in opposite directions. The mirror image of a right-helicity particle is a left-helicity particle, as shown in (b). (Note that, being a pseudovector, \mathbf{s} does not change direction under spatial inversions. Like total angular momentum \mathbf{J} and orbital angular momentum \mathbf{l} , it transforms as $\mathbf{r} \times \mathbf{p}$ does.) Until the 1950s, it was taken for granted that the laws of physics were invariant under a mirror reflection or an inversion of spatial coordinates (also called parity inversion). If parity were conserved, a spin-1/2 particle would exist in both left- and right-helicity states.

(b) Mirror Reflection of a Right-Helicity Particle

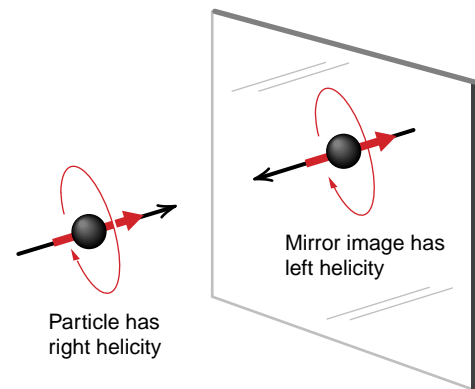

But in June of 1956, two young physicists, C. N. Yang and T. D. Lee, suggested that the weak force might violate parity conservation, and they outlined several types of experiments that could test their hypothesis. Six months later, C. S. Wu reported the results of one such experiment. Wu aligned the spins of cobalt-60 nuclei along an external magnetic field and measured the directions of the electrons emitted by those nuclei in beta decay:

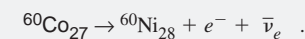

The electrons were almost always emitted in the direction opposite to the nuclear spins, as shown in (c). If parity were conserved, there should be no correlation between the spins and the momenta of the electrons emitted in the decay. A correlation between spin and

momentum is measured by the average value of the dot product $\mathbf{s} \cdot \mathbf{p}$, which changes sign under a parity inversion and therefore must be zero if parity is conserved in a given process. The nearly perfect correlation of the nuclear spins and the electron momenta in the cobalt experiment was an example of *maximal* parity violation.

To explain the violation, Lee and Yang assumed that the antineutrino was always emitted with right helicity. As shown in (d), the decay decreases the nuclear spin by one unit. Aligning the spins of the electron and the antineutrino along the nuclear spin ($1/2 + 1/2 = 1$) will make up for this decrease. If the antineutrino always has right helicity (momentum and spin aligned), the electron will have to be emitted with left helicity (momentum opposite to spin) and in the direction opposite to the nuclear spin, which is just what was observed in the cobalt experiment. Yang and Lee formalized this interpretation in the theory of the two-component neutrino (1957), which postulates that the neutrino comes in only two forms, a left-helicity ($\lambda = -1/2$) particle and a right-helicity ($\lambda = 1/2$) antiparticle. But definite helicity has a profound consequence. To have left helicity in all coordinate systems moving with constant velocity relative to each other, as required by special relativity, the left-helicity neutrino must be traveling at the speed of light. Otherwise, one could imagine observing the particle from a coordinate system that is moving faster than the neutrino. As one zipped past, the neutrino's momentum would appear to be reversed, while its spin direction would remain unchanged. The neutrino would then appear to have right helicity! So, helicity remains independent of the reference frame only if the neutrino moves at the speed of light. But then the neutrino must be a massless particle. Helicity then becomes identical to the relativistically invariant quantity known as "handedness," so the neutrino is a *left-handed* massless particle.

The theory of the two-component massless neutrino fits nicely with the Gell-Mann and Feynman formulation (1958) of the left-handed weak force (also known as the $V-A$ theory, for vector current minus axial vector current, a form that violates parity maximally). In this theory, the weak force picks out the left-handed components of particles and the right-handed components of antiparticles. Since the neutrino interacts only through the weak force, the two missing components of the neutrino (the right-handed particle and the left-handed antiparticle) would never be "seen" and would be superfluous—*unless the neutrino had mass*.

(c) Maximum Parity Violation in the Cobalt-60 Experiment

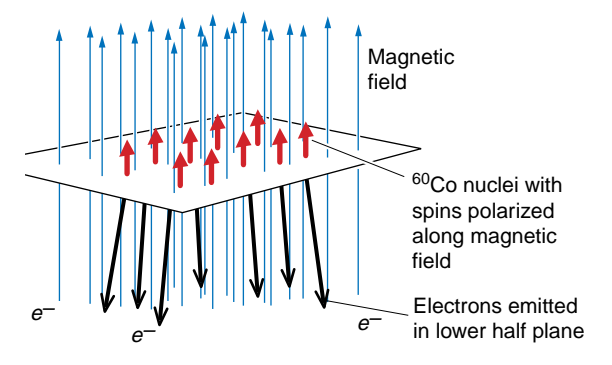

(d) Explanation of Cobalt-60 Experiment

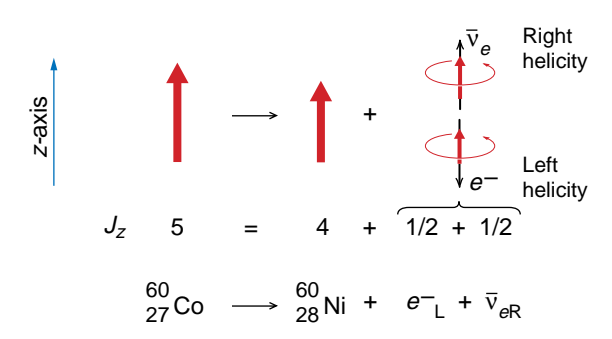

The results of the cobalt experiment were formalized in the theory of the two-component massless neutrino, according to which the antineutrino is always right-handed (or has right helicity), the neutrino is always left-handed (or has left helicity), and the neutrino is a massless particle (see the box above). But the weak force

itself was soon recognized to violate parity maximally because it acts on only the left-handed states of all quarks and leptons, whether they have mass or not. In other words, left-handedness is an intrinsic property of the weak force and not necessarily of the neutrino. Thus, in principle, the neutrino

could have a small mass.

Nonetheless, the original theory of the massless, left-handed neutrino was included in the "minimal" Standard Model, primarily because there was no evidence to the contrary. All direct measurements of neutrino masses have yielded only upper limits (see the article "Tritium Beta Decay

and the Search for Neutrino Mass" on page 86). The assumption of massless neutrinos, however, has a consequence in the minimal Standard Model: It implies that lepton-family number is conserved. Each lepton family consists of a lepton pair. The electron and its neutrino constitute the electron family; the muon and its neutrino the muon

family; and the tau and its neutrino the tau family (refer again to Figure 1). Each lepton family is part of a much larger family that also includes the quarks and the respective antiparticles of the leptons and quarks.

Conserving lepton-family number means preserving strict boundaries between the electron, muon, and tau

families. For example, the muon and the muon neutrino can transmute into each other through the weak force (no change in the muon-family number), but the muon cannot decay directly into an electron. Instead, a member of the muon family (the muon neutrino) must also be produced during muon decay. Similarly, a tau cannot decay directly

Figure 2. The Electromagnetic Force

he electromagnetic force is transmitted through the exchange of the photon, the gauge particle for the electromagnetic field.

) Electron scattering. Two electrons (straight arrows) interact with each other through the exchange of a virtual photon (wiggly line). The direction of time is from left to right. The dots represent interaction vertices, where one electron emits a photon and the other electron absorbs it.

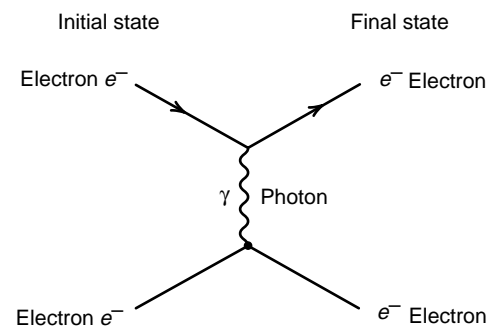

) Electron-positron annihilation and creation. When the diagram above is rotated by 90°, it represents an electron and positron that annihilate at the left interaction vertex to form a virtual photon, and then the virtual photon converts back to an electron and positron at the right interaction vertex. Note that, when an arrow points backward in time, it represents the antiparticle moving forward in time.

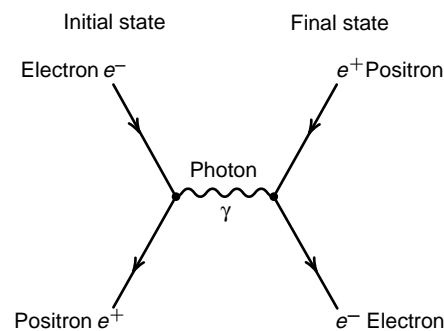

) The interaction vertex. All processes involving the electromagnetic force can be built up from the basic interaction vertex. In the left vertex, an electron emits or absorbs a photon, and in the right vertex, a photon turns into an electron-positron pair or vice versa.

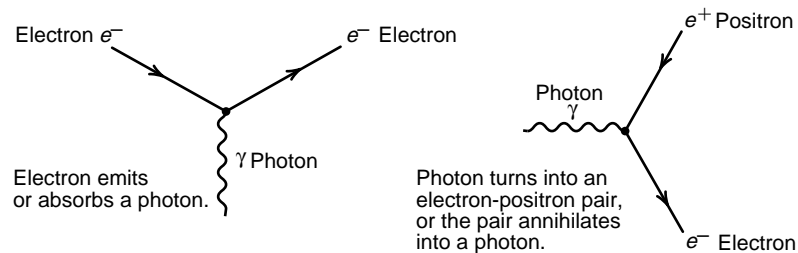

into a muon or an electron unless a tau neutrino is also produced. Finally, conservation of lepton-family number means that an electron neutrino cannot change into a neutrino from another family, or vice versa. These predictions of the minimal Standard Model have held up to increasingly precise tests.

Recent evidence, however, is changing this picture. Data from the neutrino oscillation experiment at Los Alamos, known as LSND (for liquid scintillator neutrino detector), as well as from

solar- and atmospheric-neutrino experiments, suggest that muon neutrinos can periodically change into electron neutrinos, and vice versa, as they travel through the Sun or even through empty space. One consequence would be that electron neutrinos arriving at Earth from the center of the Sun would appear to be too few in number although, in fact, the right total number would be present. Some would be “invisible” because they would have temporarily changed into another flavor—into muon or tau neutrinos

whose interactions are unobservable in the detectors being used. As shown in later sections, this oscillation from one flavor to another can happen only if the different neutrino types have different masses, so measurement of oscillation is proof that neutrinos have mass.

Positive results from the LSND oscillation experiment have therefore caused a stir in the physics community. These results could explain the “solar-neutrino puzzle” (the apparent deficit in the number of solar neutrinos) and could also have impact on other topics in astrophysics and cosmology that involve large numbers of neutrinos. On a more abstract note, nonzero neutrino masses and oscillations among flavors would parallel the properties and behaviors seen among the quarks and would thus point toward a greater symmetry between quarks and leptons than now exists in the Standard Model. They might even point toward a more encompassing and unifying symmetry that has been anticipated in the Grand Unified Theories, in which quarks and leptons are different aspects of the same field and the strong, weak, and electromagnetic forces are due to a single symmetry.

Gauge Symmetries in the Standard Model

The Standard Model is built almost entirely from symmetry principles, and those principles have enormous predictive power. Symmetry means an invariance of the laws of physics under some group of transformations. And in the formalism of quantum field theory, the invariance implies the existence of a conserved quantity. One example is the group of rotations. We take for granted, and know from high-precision measurements, that space has no preferred direction and that we can rotate an isolated system (a group of atoms, a solar system, a galaxy) about any axis (or rotate the coordinates we use to describe that system) and not change the laws of physics observed by that system. This property is called

rotational invariance, and it has the profound consequence that the total angular momentum of an isolated system is conserved and therefore never changes. Similarly, if a system is invariant under time translations, its total energy is conserved. If a system is invariant under spatial translations, its total linear momentum is conserved.

In addition to these space and time symmetries, the Standard Model has certain powerful internal symmetries, called local gauge symmetries, that define both the charges of the quarks and leptons and the specific nature of the forces between them. Just as cubic symmetry implies the existence of four corners, six faces, and a group of rotations that interchange the position of the cube’s faces and corners, the internal symmetries of the Standard Model imply that (1) the quarks and leptons fall into certain groups or particle multiplets, (2) the charges of the particles in each multiplet are related in a definite way, and (3) there is a group of internal rotations that transform one member of each multiplet into other members of that same multiplet.

But there is much more. Local gauge symmetries are those in which the magnitude of the transformation can vary in space and time. If the results of experiments are to stay invariant under such transformations (which is what symmetry means), gauge particles must exist that transmit or mediate the forces between the quarks and leptons. One quark or lepton emits a gauge particle, and another quark or lepton absorbs it. Through this exchange, each “feels” the force of the other. Further, the interac-

²The exchange of the photon does not change the identity of the charged particle; it only rotates the phase of the quantum field that describes the charged particle. The point of the local symmetry is that the phase is not observable. That phase rotation is compensated for by the photon field, and thus the interaction Lagrangian is invariant under phase rotations at every space-time point. The local gauge (or phase) symmetry of electromagnetism is a local unitary symmetry in one dimension, U(1). The symmetry implies electric current conservation at every point as well as global charge conservation.

tion between the gauge particle and the quark or lepton actually causes one of the internal rotations defined by the local gauge symmetry, that is, the emission or absorption of a gauge particle causes that quark or lepton to transform into another member of the same multiplet. To give a geometrical analogy, if the world were perfectly symmetrical and the quarks and leptons in Figure 1 were like the faces of a cube, then the action of the gauge particles would be to rotate, or transform, one face (quark or lepton) into another.

The Electromagnetic Force. In the Standard Model, each force (strong, weak, and electromagnetic) is associated with its own local gauge symmetry, which, in turn, defines a set of charges and a set of gauge bosons that are the “carriers” or mediators of the force between the charged particles. The electromagnetic force is the simplest to describe. Figure 2(a) shows that two electrons, or any particles carrying electric charge, interact by the exchange of a photon, the gauge boson for the electromagnetic field. The exchange process can be pictured as a game of catch:

One electron emits (throws) a photon, the other electron absorbs (catches) it, and the net result is that the two particles repel, or scatter from, each other. The classical electromagnetic field that explains how particles can interact at a distance is thus replaced by the exchange of a gauge particle.² The photon, of course, exists as an independent particle and can itself transform into a particle-antiparticle pair, most often an electron-positron pair. Figure 2(b) illustrates this process, and Figure 2(c) shows the basic interaction vertex. The local symmetry implies that all possible interactions involving the photon and electrically charged particles can be built up from this basic interaction vertex.

Finally, the local gauge symmetry holds only if the photon is identically massless, and the symmetry guarantees that electric charge is a conserved quantity, that is, the sum of the electric

charges before a reaction equals the sum of the charges after the reaction.

The Strong Force. The local gauge symmetry for the strong force is called color symmetry. The color charge has three distinct aspects that, for convenience, are labeled red, green, and blue (no relation to real colors is intended). The gauge particles are called gluons, the quarks can carry any of the three color charges, and two colored quarks interact and change color through the exchange of one of the eight colored gluons. Like the gauge symmetry for the electromagnetic force, the gauge symmetry for the strong force implies that the gluons are massless and that the total color charge is conserved. Because the gluons carry color, and are thus like electrically charged photons, the strong force is highly nonlinear and has some very bizarre properties. One is that quarks can never appear individually, and another is that all observable states of quarks and antiquarks (protons, neutrons, pions, and so forth) are colorless bound states, that is, they have no net color charge.

In the discussions that follow, we can ignore the strong force because leptons do not carry the color charge and the part of the Standard Model that describes the color interactions of the quarks (known as quantum chromodynamics) will not be affected by new data on neutrino masses and mixings.

The Weak Force. The Standard Model identifies two local gauge symmetries for the weak force and, therefore, two types of weak charges (weak isotopic charge and weak hypercharge). As a consequence, there are two types of gauge particles, the W and the Z^0 bosons, that carry the weak force between particles with weak charges. The neutrino, although electrically neutral, carries both weak isotopic charge and weak hypercharge and thus interacts with matter through the exchange of either the W or the Z^0 .

Let us first consider the processes mediated by the W . This gauge boson

Figure 3. Beta Decay and Other Processes Mediated by the W

The W is the charged gauge particle of the weak force, so processes mediated by the W involve the exchange of one unit of electric charge. Quarks and leptons therefore change their identities through the emission or absorption of the W . In all the processes shown here, the arrow of time is from left to right, and an arrow pointing backward represents an antiparticle moving forward in time. The arrow on the W indicates the flow of electric charge. Note also that in each of these processes, electric charge is conserved at every step.

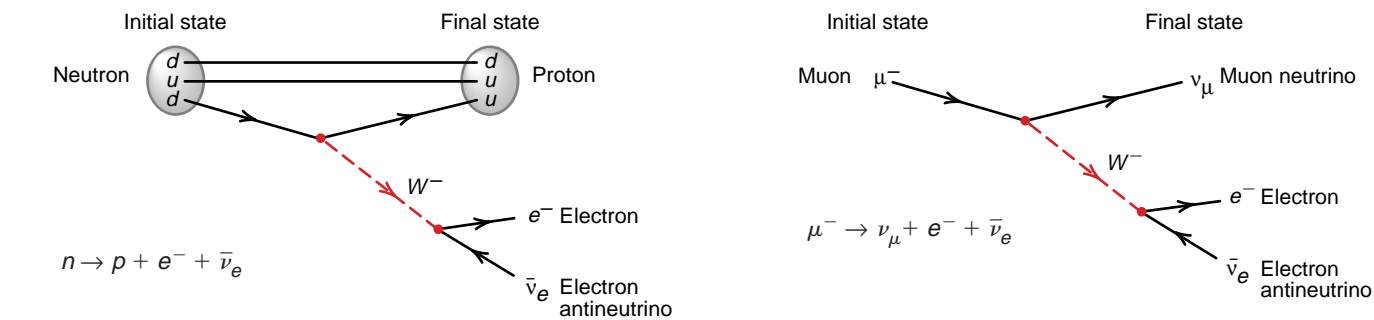

(a) Neutron beta decay. A neutron decays to a proton when a d quark in the neutron emits a W^- and transmutes into a u quark. Like the photon, the W^- can decay into a particle and an antiparticle, but here the particle is the electron, and the antiparticle is the electron antineutrino.

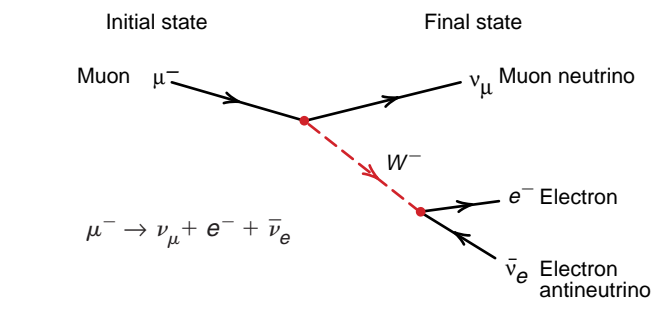

(b) Muon beta decay. This process is exactly analogous to the beta decay of the neutron. The muon transforms into a muon neutrino as it emits a W^- ; the W^- decays into an electron and an electron antineutrino.

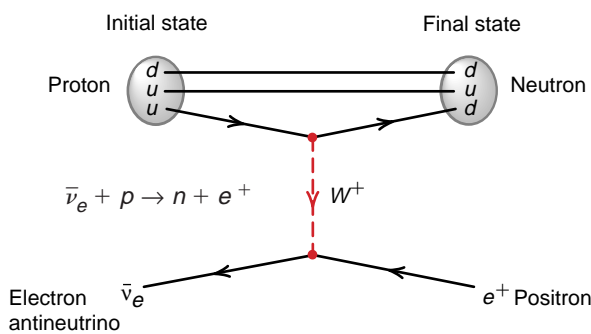

(c) Inverse beta decay. An electron antineutrino interacts with a proton by exchanging a W^+ . The u quark emits a W^+ and transmutes to a d quark (thus the proton turns into a neutron). The electron antineutrino transmutes into a positron as it absorbs the W^+ .

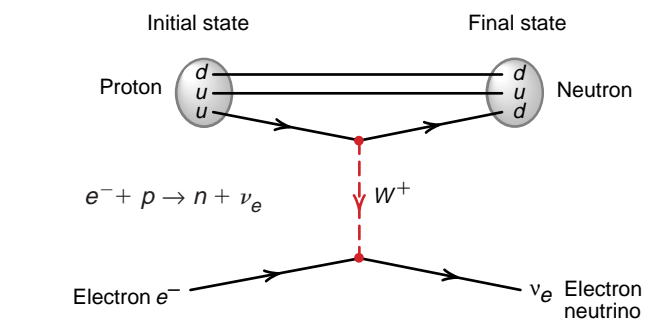

(d) Electron capture. This process is similar to inverse beta decay, except that an electron interacts with the proton. The electron transmutes into an electron neutrino as it absorbs the W^+ .

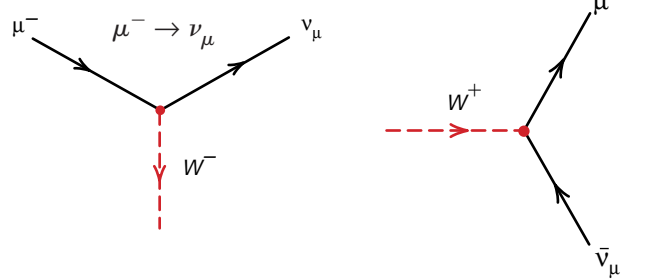
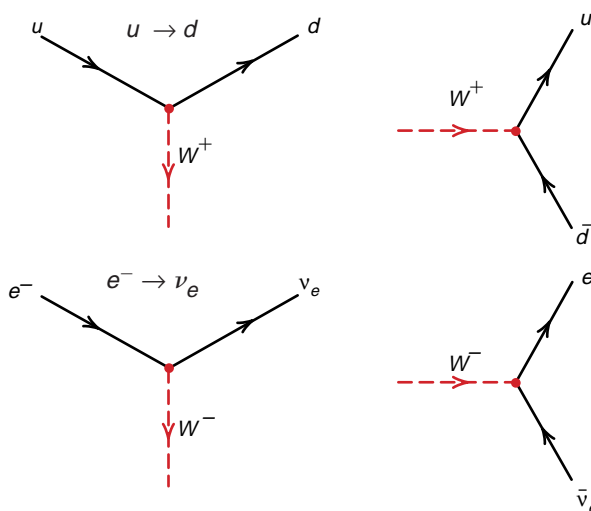

(e) Basic interaction vertices of the charged-current weak force. All the processes illustrated above can be built from variations of the interaction vertices shown here. These are analogous to the vertices shown in Figure 2 for the electromagnetic force, except here the gauge particle, the W , carries one unit of electric charge.

comes in two forms, the W^+ and the W^- . Each carries one unit of electric charge (plus or minus, respectively), so that when a particle carrying the weak isotopic charge emits or absorbs a W , it gains or loses one unit of electric (and weak isotopic) charge. The particle thereby changes its identity. Figure 3 illustrates neutron beta decay, muon beta decay, inverse beta decay, and electron or positron capture, all of which are processes mediated by the W .

The transmutation of the down quark into the up quark through emission of the W^- is the origin of the transmutation of a neutron into a proton in ordinary beta decay. In inverse beta decay, the process used by Reines and Cowan to detect the electron antineutrino, an up quark transmutes into a down quark as it emits a W^+ , and an electron antineutrino transmutes into a positron as it absorbs that W^+ . Because of the exchange of electric charge, the processes involving the exchange of the W are called “charged-current” weak processes. They are to be contrasted with the “neutral-current” processes mediated by the Z^0 , in which no electric charge is exchanged. Note that this picture of the weak force, in which particles interact at a distance through the exchange of the W , modifies Fermi’s original current-current theory of beta decay, in which two currents interacted at a point (see the box “Fermi’s Theory of Beta Decay and Neutrino Processes” on page 8). The distance over which the W is exchanged is very short, on the order of 10^{-16} centimeter, which is substantially less than the diameter of a proton.

The scattering of electron neutrinos by electrons is a purely leptonic reaction that illustrates both charged-current and neutral-current modes (see Figure 4). In charged-current scattering, the electron emits a W^- and loses one unit of negative electric charge to become an electron neutrino. At the other end of this exchange, the electron neutrino absorbs the W^- and gains one unit of negative electric charge to become an electron. The initial and final particles are the same, but each has been transmuted into the other

Figure 4. Electron Neutrino–Electron Scattering
The electron and the electron neutrino can interact through the exchange of either the W , shown in (a), or the Z^0 , shown in (b).

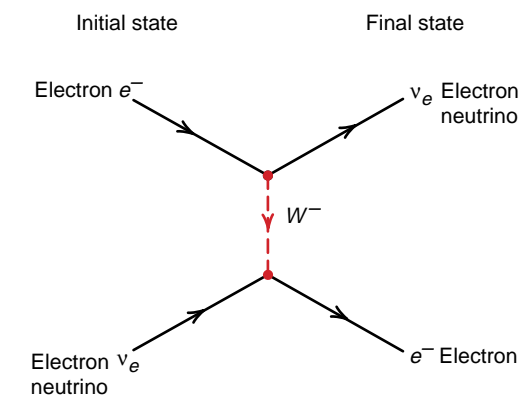

(a) Charged-current scattering. An electron and an electron neutrino interact through exchange of a W^- . The electron transmutes into an electron neutrino as it emits a W^- , and the electron neutrino transmutes into an electron as it absorbs a W^- .

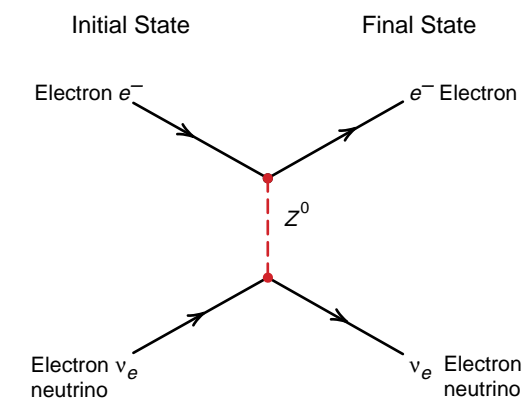

(b) Neutral-current scattering. The electron and electron neutrino interact through exchange of the Z^0 . No charge is transferred, and the particles maintain their identities.

through the charged-current weak interaction. In neutral-current scattering, the electron neutrino emits the Z^0 , and the electron absorbs it. The two particles scatter from each other, but each maintains its identity as in electromagnetic scattering. All neutrino types can interact with electrons through neutral-current scattering, but only electron neutrinos can interact with electrons through charged-current scattering. That additional interaction may be important in enhancing the oscillation of electron neutrinos that exit the Sun (see the article “MSW” on page 156).

It is not coincidental that neutral-current scattering resembles electromagnetic scattering. One of the great successes of the Standard Model was to show that the weak force and the electromagnetic force are related. The two types of weak charges, when added together in a specific linear combination, are equal to the electric charge.

Consequently, most quarks and leptons carry both types of weak charge as well as electric charge and can interact through exchange of the photon, the W , or the Z^0 . For the neutrino, however, the specific sum that equals the electric charge (and couples to the photon) is zero, so that the neutrino is electrically neutral. (The electroweak theory, which describes the electromagnetic and weak forces, unifies the description of the photon and the Z^0 in a complicated way that will not be discussed in this article.)

Now, let us consider the particle multiplets that are consistent with the local symmetries of the weak force. Figure 5 lists the quarks and the leptons, along with their weak and electric charges. These particles fall naturally into three families (columns) consisting of a pair of quarks and a pair of leptons. Each pair is a doublet whose members transform into each other under the rotations of the local symme-

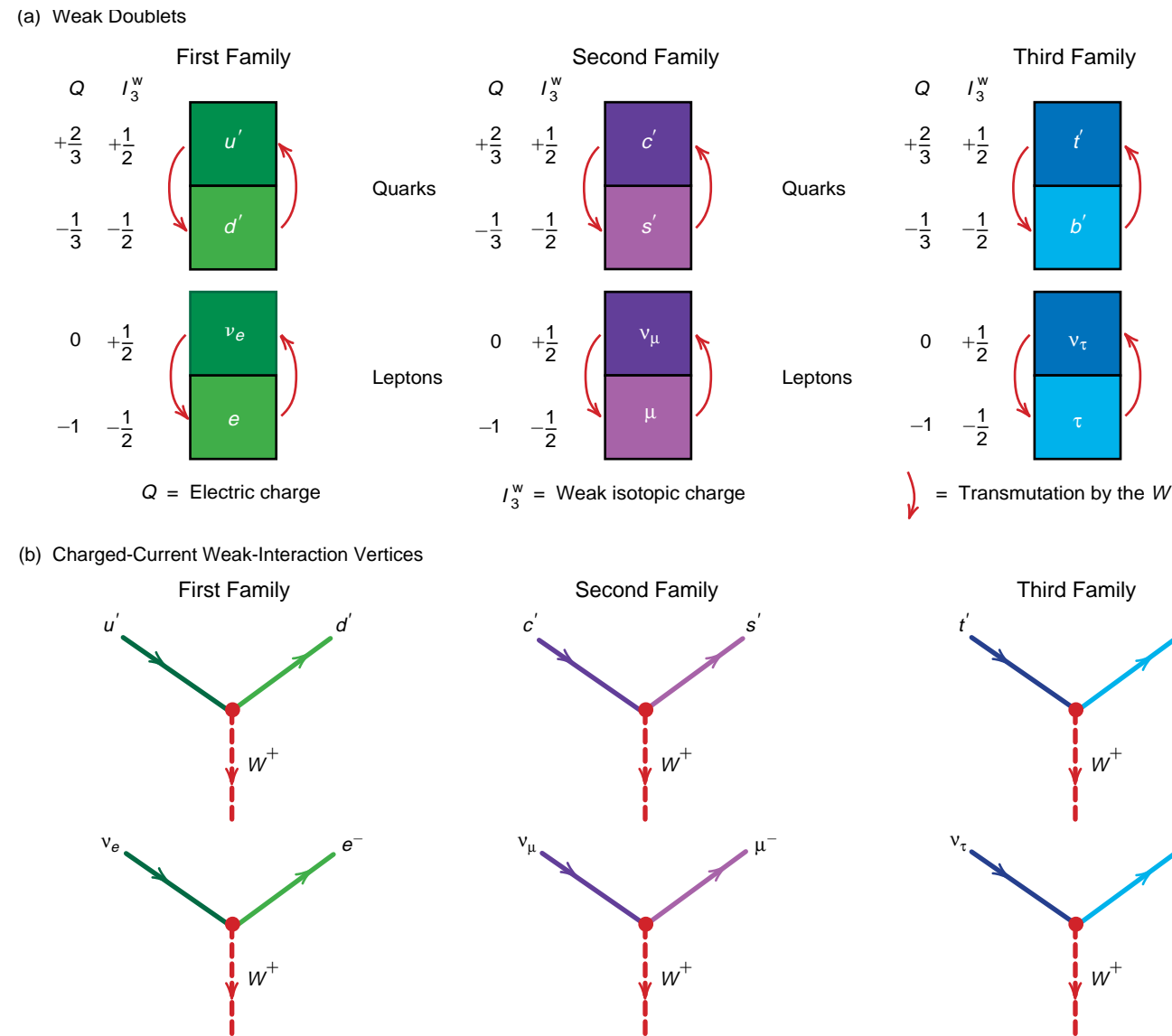

Figure 5. The “Weak” States—Particles Defined by the Local Symmetries of the Weak Force

the particle doublets, defined by the weak isospin symmetry of the weak force, are listed in (a) along with their electric charge Q and weak isotopic charge I_3^W . The particles fall into three families, each containing a quark weak isospin doublet and a lepton weak isospin doublet. (For each weak particle doublet, there is also a corresponding weak antiparticle doublet that is not shown.) The quarks in each doublet have been labeled with primes, u' and d' for example, to indicate that the weak quark states are distinct from the quark states shown in Figure 1. (The distinction will be made clear in the text.) As indicated by the red arrows and also expanded in (b), one member of the

doublet transforms into the other member by absorbing or emitting the W , the gauge particle for the charged-current weak interaction. Only the left-handed particles (or right-handed antiparticles) carry the weak isotopic charge and are members of the doublet. In the quark sector, the u' quark transforms into the d' quark and vice versa, the c' quark transforms into the s' quark and vice versa, and the t' quark transforms into the b' quark and vice versa. In the lepton sector, the electron and the electron neutrino transform into each other through interaction with the W , as do the muon and muon neutrino and the tau and tau neutrino. This universal interaction with

the W means that the muon and the muon neutrino or the tau and the tau neutrino wherever the latter pair appears in the charge-changing weak processes in Figures 3 and 4. (Whether those processes actually occur with the heavier leptons depends on the available energy.) The similarities among the weak isospin pairs extend to the electric-charge assignments as well. In each quark doublet, one member has electric charge $+2/3$; the other, $-1/3$. In each lepton doublet, one member has charge zero, and the other has charge -1 . The weak-isotopic-charge assignments are likewise maintained from family to family.

try group (called weak isospin)³. The red arrows indicate the transmutation of one member into the other through absorption or emission of the W . Thus, members of a weak isospin doublet are like the two faces of a coin, and interaction with the W flips the coin from one face to the other. (Note that, for each weak particle doublet, there is a corresponding weak antiparticle doublet. Because the charge-changing weak force is left-handed, the particle doublets include only the left-handed components of the particles, whereas the antiparticle doublets include only the right-handed components of the antiparticles. That technicality becomes important in the later discussion of mass.)

Alternatively, if the W is emitted and not absorbed by another weakly charged particle, it decays into one member of the doublet and the antiparticle of the other member of the doublet. This occurs, for example, in beta decay (refer to Figure 3). The W^- is not absorbed but decays to an electron and an electron antineutrino ($W^- \rightarrow e^- + \bar{\nu}_e$). Likewise, the W^+ can decay to a positron (antielectron) and an electron neutrino ($W^+ \rightarrow e^+ + \nu_e$).

This brief introduction to the forces associated with and derived from the local gauge symmetries needs one crucial addition. The local gauge symmetries of the weak force are *not* exact symmetries of nature, and one sign of the symmetry breaking is that, unlike the photon and the gluons, which must be massless to preserve the local gauge symmetry, the W and the Z are very massive, weighing about 100 times the mass of the proton. More precisely, the mechanism that gives mass to the particles breaks the weak symmetries and, in certain situations, causes the weak charges not to be conserved. However, processes mediated by the weak gauge particles do conserve the weak charges, and the original symme-

³Weak isospin symmetry is an example of the special unitary symmetry in two dimensions, $SU(2)$. Rotational symmetry, which leads to the allowed states of angular momentum, is another example of $SU(2)$ symmetry.

try is apparent in them. Also, the local gauge symmetry specific to electromagnetic interactions is not affected at all by the symmetry breaking, and the electric charge is always conserved.

These complications notwithstanding, each of the forces in the Standard Model is derived from a local gauge symmetry; the three forces, therefore, look similar in that they act through the exchange of gauge bosons. The reliance on local gauge symmetries has worked so well that many theorists have tried to extend this idea even further. They are trying to find a local gauge symmetry that combines into one all the separate symmetries associated with the strong and electroweak forces. Such theories predict that the quarks and leptons within a family will fall into one multiplet, one set of particles that transform into each other through the gauge particles associated with the local symmetry. This effort is called grand unification and is the basis of the Grand Unified Theories.

It is remarkable that theorists anticipated not only the structure of the electroweak force, but also the existence of the charmed quark (the partner to the strange quark) and later the top and the bottom quarks by identifying the correct local gauge symmetry for the weak force and then predicting that all quarks and leptons form doublets under that symmetry.

The symmetry of the weak force was not immediately apparent from experiment for several reasons. For example, the charm, top, and bottom quarks and the tau particle are very heavy. They were not observed at low energies, and thus half of all family members were not known to exist. Also, the physical quarks listed in Figure 1 are not identical with the members of the quark doublets listed in Figure 5. In the next section, we examine what is known about the differences between those two sets of quark states because there is a strong possibility that leptons may be described by two sets of states analogous to the quark sets. In that case, neutrino oscillations would be predicted. These analogous properties of quarks

and leptons are expected in all theories in which these particles are relatives and can transmute into each other.

The Mysteries of Masses and Families in the Standard Model

Figures 1 and 5 reflect two different ways of defining and placing particles in families: The families in Figure 1 contain particles with definite mass (the unprimed quarks), whereas those in Figure 5 contain particles defined by the local gauge symmetries (the primed quarks). These local gauge symmetries provide the guiding principles in the construction of the Standard Model and in most extensions to it; therefore, the weak states described in Figure 5 offer a fundamental starting point in shaping our understanding of the fundamental particles.

If we were to ignore the masses of the particles and focus on the symmetries, each family would look like a carbon copy of the other two. In other words, each particle would have a “clone” in each of the other two families that has identical weak and electric charges and that has a partner with which it forms a doublet under the weak force. The quark clones are $u', c',$ and t' and their weak partners $d', s',$ and b' , respectively. The lepton clones are $e, \mu,$ and τ and their weak partners $\nu_e, \nu_\mu,$ and ν_τ , respectively.

In fact, if the local gauge symmetries of the weak force were exact, the quarks and leptons would all be massless. There is no way to include in the theory a “mass” term that remains invariant under those local symmetries. (The general features of mass terms for spin-1/2 particles are described in the sidebar “Neutrino Masses” on page 64.) In reality, particles do have mass, and thus the Standard Model contains a symmetry-violating mechanism known as the Higgs mechanism. This mechanism was specifically introduced into the Standard Model to explain the masses of the weak gauge particles,

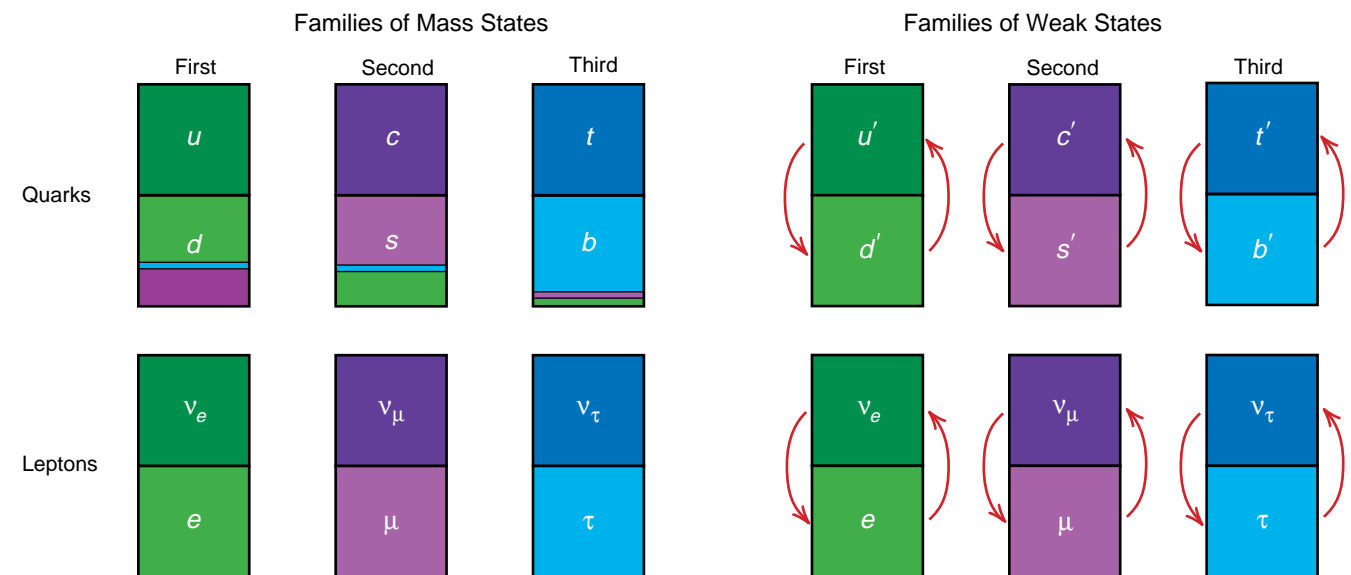

Figure 6. A Comparison of Mass States and Weak States in the Standard Model

The mass states (colored squares at left) and the weak states (colored squares at right) are two alternative descriptions of the spin-1/2 particles of the Standard Model. Here, the first, second, and third families of weak states are represented by colors: the greens, the purples, and the blues, respectively. By convention, all mixing among the quarks is placed in the lower half of the mass state quark doublets. Thus, the mass states d , s , and b are shown as mixtures of the particular colors that represent the quark weak states d' , s' , and b' . For example, the mass state d is mostly green but contains a purple stripe whose area represents the fraction of d in the weak state s' , and so forth. Most of the quark mixing occurs between the first and second families. The mass and weak states for the quarks in the upper half of the doublets are equivalent: $u = u'$, $c = c'$, and $t = t'$. In the Standard Model, there is no mixing among the leptons, and so the lepton weak states and mass states are identical.

which must be very large to account for the short range and the reduced strength of the weak force relative to the electromagnetic force.

The same general mechanism is assumed to explain the masses of the quarks and leptons, but the theory has so many undetermined constants that experiment rather than theory is required to determine the masses. A theory of masses for spin-1/2 particles has yet to be found. Whatever the solution, it must give different masses to the clones in each family, because as can be seen in going from left to right along any row in Figure 1, the three families form a mass hierarchy from light to heavy. That is a tantalizing pattern with no explanation.

There are more mysteries surrounding the states defined by the weak symmetries (those shown in Figure 5). Why do quarks and leptons fall naturally into distinct families? Are these two types of particles related to each other in some way that is not yet apparent but that is anticipated in the Grand Unified Theories? Why are there three different families with exactly the same properties under the weak force? And why do they have different masses? Here, the Grand Unified Theories are no guide at all.

A related mystery is the one mentioned at the beginning of this section—the “nonalignment” between

the different quark states. Experiment shows that the quark states of definite mass (shown in Figure 1) are not the same as the quark states that make up the weak doublets. (Recall that the quark weak states have been labeled with primes.) The weak force seems to have a kind of skewed vision that produces and acts on quarks that are mixtures of the mass states from the different families. Equivalently, the symmetry-breaking mechanism that gives particles their masses mixes the quark clones in the weak families to create mass states.

Figure 6 stresses this point. Each family of weak states is denoted by a different color (green, purple, and blue), and the mass states are shown as mixtures of weak states (mixed colors). Areas of color represent the fraction of a mass state that is in a particular weak state. Notice that most of the quark mixing occurs between the first two families. The exact amounts of mixing cannot be derived from theory; instead, they are determined experimentally and included in the Standard Model as arbitrary parameters.⁴ Notice also that, by convention, all the mixing is placed in the lower half of the quark doublets (the d , s , and b quarks are mixtures of d' , s' , and b').⁵ Therefore, the weak and the mass states for the quarks in

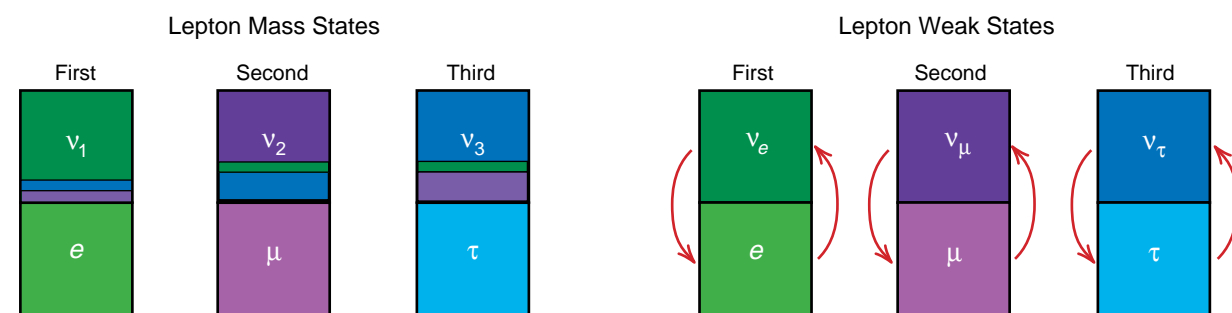

Figure 7. Lepton Mass States and Weak States for Nonzero Mixing among the Leptons

If neutrinos have mass and there is mixing among the leptons as there is among the quarks, all the mixing can be placed among the neutrinos, the neutral components of the weak doublets. Compare these lepton states with those in Figure 6. Although there is no mixing among the leptons in the Standard Model, present oscillation data suggest that such mixing may indeed occur. However, the pattern of mixing among the leptons is an open question. This figure suggests one possible pattern (shown by the color mixtures), which involves mainly the second and third families.

the upper half of the doublets are equivalent: $u = u'$, $c = c'$, and $t = t'$. It should be stressed, however, that no matter which way one views the mixing, the quark states that transmute into each other through the action of the W (red arrows) are *always* the members of the weak doublets.

The mixing that results from the nonalignment between mass and weak states is a natural outcome of the symmetry-breaking mechanism through which particles acquire mass in the Standard Model. According to the Higgs mechanism, the ground state, or lowest-energy state, has no physical particles (it is called “the vacuum”), but it contains an everpresent background of virtual, spin-zero Higgs particles. That background interacts with the quarks, leptons, and gauge bosons and provides a “drag” on them, which we observe as rest mass. The Higgs particles are weak doublets, and the background of virtual Higgs particles, by definition, has a nonzero value of weak charge. When the quarks and leptons in

⁴The amounts of mixing determined from experiment become the numbers in the famous CKM matrix (named after Cabibbo, Kobayashi, and Maskawa), the unitary matrix that rotates the complete set of quark mass states into the complete set of quark weak states or vice versa.

⁵The freedom to put all the mixing in one-half of a weak isospin doublet depends on the fact that the weak force always acts between the two members of a weak doublet.

the weak doublets “interact” with the Higgs background and acquire mass, the resulting states of definite mass do not conserve the weak charge and thus break the symmetry. Indeed, they cease being the states in the weak doublets. In the most general version of this symmetry-breaking, mass-generating scheme, the particles that acquire definite masses through interaction with the Higgs background are mixtures of the weak states from the different weak families. Indeed, the quarks in the Standard Model follow this most general scheme. The Higgs mechanism thus causes the mismatch between the quark weak states and mass states.

Since the leptons also acquire mass through the Higgs mechanism, one might expect to find a similar type of mixing among the lepton weak states and mass states. So far, experiments have not confirmed that expectation, and the Standard Model holds that the lepton mass states and weak states are essentially identical. The weak force always appears to act on the weak doublets within a family, and there is no mixing of weak states through the Higgs mechanism in the lepton sector. Consequently, one can define a quantity called lepton-family number that is conserved by all weak interactions involving the leptons. (Lepton-family numbers and the corresponding conservation laws are discussed later in this article.)

Why is there mixing among the quarks and not among the leptons? In the Standard Model, this difference follows directly from the assumption that all three neutrinos have the same mass, namely, zero. The mathematical argument is given in the sidebar “Family Mixing and the Origin of Mass” on page 72.

But as we said earlier, there is no fundamental principle that keeps the neutrinos massless. If they have small masses and acquire those masses through the Higgs mechanism, the mass states would likely be mixtures of the weak states. The lepton mass states would then change to look like those in Figure 7, in which the neutrino mass states ν_1 , ν_2 , and ν_3 are related to the three weak states ν_e , ν_μ , and ν_τ by a set of mixing parameters analogous to those relating the quark weak states to the quark mass states.

Mixing among the leptons would allow processes that violate lepton-family number, but because neutrinos have such small masses, we would expect most of those processes to be barely detectable. In fact, in a particular range of masses and mixings, the *only* example of lepton-family mixing that is accessible to measurement is neutrino oscillation, the spontaneous periodic change from one weak family to another as the neutrino propagates freely through space.

Look where we have arrived. We are saying that mixing among the leptons is a natural extension of the Standard Model if neutrinos have mass and that the most likely place to observe the mixing is in the peculiar manifestation of quantum mechanics known as neutrino oscillation. Furthermore, since oscillations can only occur if the neutrino types have different masses, direct observation of neutrino oscillations would reveal the relative sizes of the neutrino masses. No wonder that physicists have been searching for this phenomenon for well over two decades.

We will turn to the theory and detection of neutrino oscillations and examine how two types of information—neutrino masses and the amount of mixing across families—can be determined from oscillation data. But first, we will backtrack to the quarks and explain how mixing works.

Mixing among the Quarks

Consider ordinary neutron beta decay and suppose we had no idea of the difference between the weak states and the mass states. A neutron transforms into a proton, and an electron and an electron antineutrino are created in the decay process,

$$n \rightarrow p + e^- + \bar{\nu}_e \quad (1)$$

The neutron is made of the triplet of quark mass states udd , and the proton is made of the triplet of quark mass states ud . At the quark level, the change of a neutron to a proton looks like the transmutation of a down quark to an up quark $d \rightarrow u$ (refer to Figure 3a). However, when the strength (effective coupling) of the force responsible for neutron beta decay is measured, it is found to be 4 percent smaller than the strength of the force responsible for muon beta decay (refer to Figure 3b). But these are just two different examples of the charged-current weak force, and theory says that the strength of the force should be

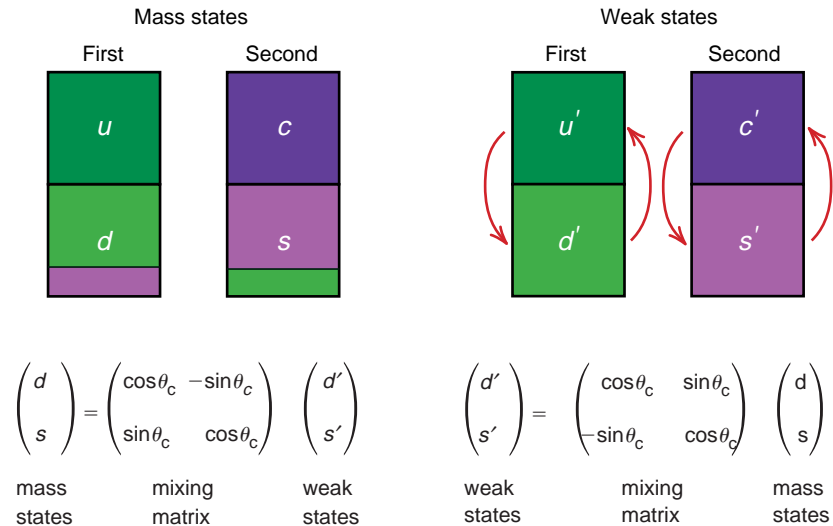
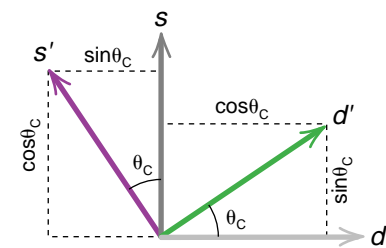

Figure 8. Two-Family Mixing among the Quarks

The quark weak states and mass states are like two alternative sets of unit vectors in a plane (see diagram at right) that are related to each other by the rotation through an angle θ_c . In this analogy, one mixing matrix is just a rotation matrix that takes, say, the mass coordinates d and s into the weak-force coordinates d' and s' ; its inverse is the rotation through the angle $-\theta_c$ that takes the weak coordinates into the mass coordinates.



identical in the two processes.

Where did the missing strength of the weak force go? It turns out to be “hiding” in the beta decay of the lambda particle (Λ):

$$\Lambda \rightarrow p + e^- + \bar{\nu}_e \quad (2)$$

The lambda (uds) differs from the neutron (udd) by having a strange quark replace a down quark. The lambda decays to a proton because the strange quark transforms into an up quark, $s \rightarrow u$. Lambda beta decay is thus analogous to neutron beta decay, and the sum of the strengths for lambda and neutron beta decays equals the strength for muon beta decay.

Why is this so? The answer is mixing—the fact that the quark mass states that appear in the neutron and the lambda are mixtures of the quark weak

states. The mathematics of this mixing is interesting not only for tracking down the missing 4 percent, but also because it has the same form as the mixing that causes neutrino oscillations. For simplicity, we will consider mixing only, which accounts for most of the mixing among the quarks anyway.

Figure 8 shows the quark weak states and the quark mass states in the two-family picture. Underneath the families of mass states, the 2×2 rotation matrix is shown, which rotates the weak states d' and s' into the mass states d and s ; the inverse transformation is shown under the families of weak states. In this quantum mechanical world, the quark mass states s and d are one complete description of the quarks with electric charge $Q = -1/3$. The quark weak states s'

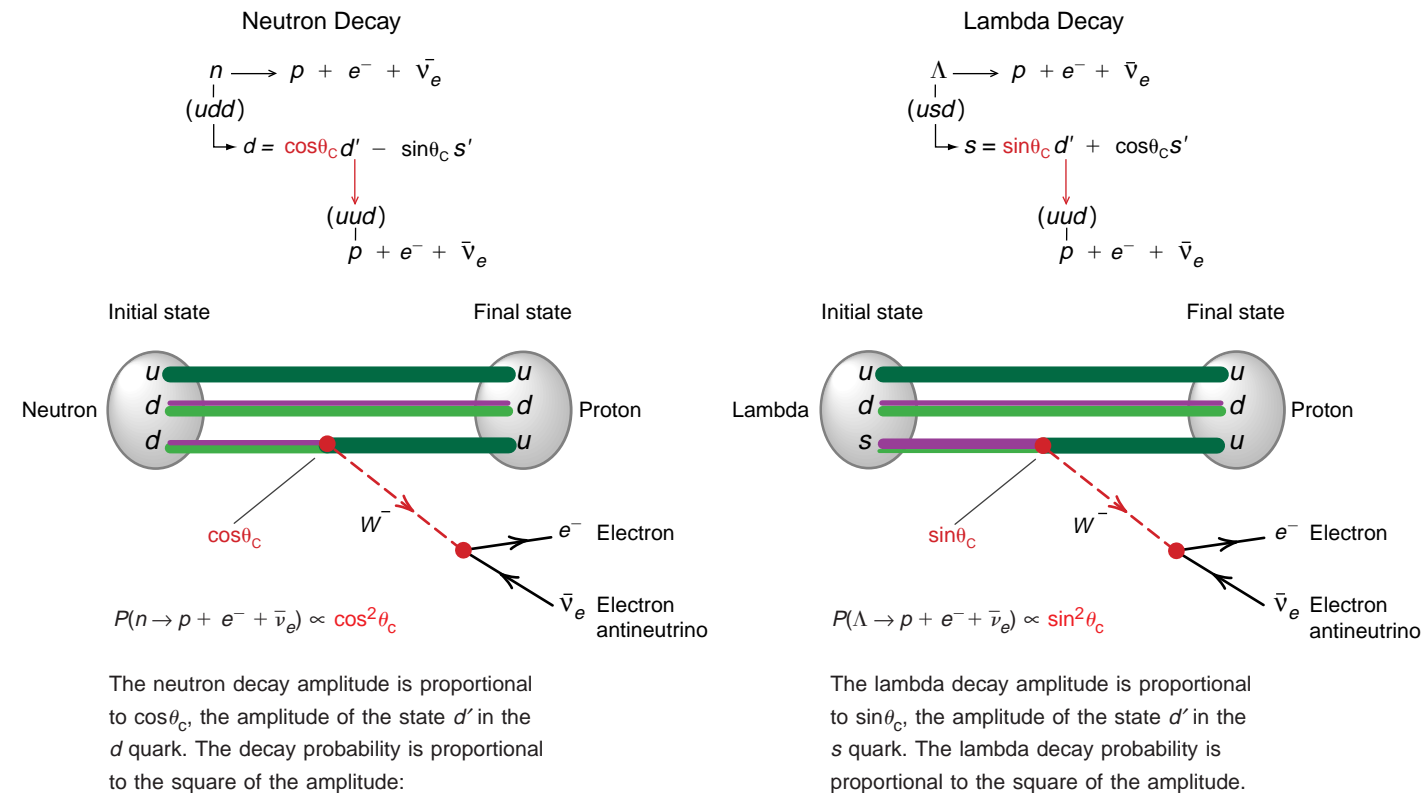

Figure 9. Neutron and Lambda Beta Decay in the Two-Family Picture

In beta decay, the neutron transforms into a proton through the transition $d \rightarrow u$, and the lambda transforms into a proton through the transition $s \rightarrow u$. However, in both cases, the W acts between members of the quark weak isospin doublets in the first family, that is, the W causes the transition $d' \rightarrow u$. So, only the fraction of the d in the state d' takes part in neutron decay, and only the fraction of the s in the state d' takes part in lambda decay. The multicolored lines for d and s show their fractional content of d' and s' .

and d' are an alternative description, and the two sets of states are like two independent sets of orthogonal unit vectors in a plane that are related to each other by a rotation through the angle θ_c , also called the mixing angle. Thus, the weak states can be described as linear combinations of the mass states, and conversely, the mass states can be described as linear combinations of the weak states.

The phenomenon of mixing, while perhaps nonintuitive, emerges naturally from the fundamental tenet of quantum mechanics that particles have wavelike properties. Like sound and light waves, matter waves, or quantum mechanical states, can add together to form a coherent linear superposition of waves. We will see later that the neutrinos produced in weak processes may like-

wise be linear superpositions of different neutrino mass states, and those mass states, or matter waves, can generate the interference patterns that we call oscillations.

But first, let us track down the 4 percent decrease in the expected rate of neutron beta decay. Figure 8 also shows the weak quark doublets that transform into each other through interaction with the W in the two-family picture. The weak doublets are not (u, d) and (c, s) , but rather (u, d') and (c, s') . Now, consider the beta decay of the lambda and the neutron. As shown in Figure 9, both decays involve the transition $d' \rightarrow u$. The d quark in the neutron and the s quark in the lambda are mass states that contain a fraction of d' . The compositions of these mass states are given by

$$\begin{aligned} |d\rangle &= \cos\theta_c |d'\rangle - \sin\theta_c |s'\rangle; \\ |s\rangle &= \sin\theta_c |d'\rangle + \cos\theta_c |s'\rangle. \end{aligned} \quad (3)$$

Figure 9 also illustrates that the transition amplitude for a neutron to turn into a proton (that is, for a d quark to turn into a u quark) is proportional to $\cos\theta_c$, or the amplitude of the d quark that is in the state d' . Similarly, the transition amplitude for the lambda to turn into a proton (that is, for an s quark to change into a u quark) is proportional to $\sin\theta_c$, the amplitude of the s quark that is in the state d' .

The rate of neutron beta decay is proportional to the square of that transition amplitude and is thus proportional to $\cos^2\theta_c$. The rate of lambda beta decay is proportional to $\sin^2\theta_c$. The sum of the rates for the two processes equals the rate for the transi-

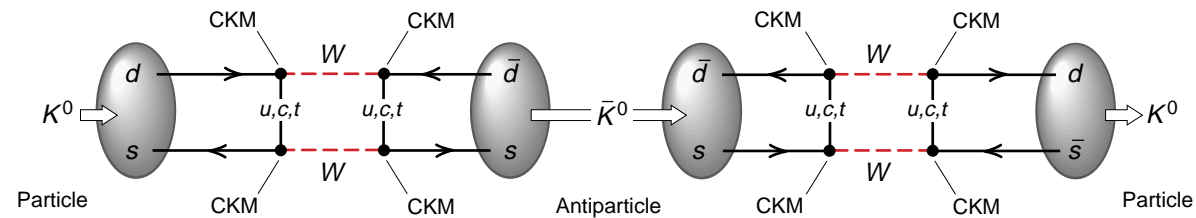

Figure 10. Oscillation of the Neutral Kaons
 The neutral kaon K^0 ($s\bar{d}$) can transform into its antiparticle \bar{K}^0 ($\bar{s}d$) and back again, in each case through the four weak-interaction vertices shown above. The CKM matrix at each vertex indicates that the transitions mediated by the W are between members of the weak doublets, and they can proceed only because the quark mass states in the neutral kaons contain mixtures of the weak states d' , s' , and b' .

on of d' into u . That rate is the same for transitions between all weak doublets, including the leptonic transition $\mu \rightarrow \nu_\mu$ in muon beta decay shown in Figure 3(b).

The mixing angle θ_c for these first two families is called the Cabibbo angle, and it has been determined from experiment. The 4 percent decrease in the rate of neutron beta decay relative to muon beta decay provides a measure of that angle: $1 - \cos^2\theta_c = \sin^2\theta_c \approx 0.04$. And that decrease is made up for by the rate of lambda beta decay. The measured value for $\sin^2\theta_c$ is 0.22.

In the Standard Model, the mixing between the quark weak and mass states occurs among the three families, not just two, and the amounts of mixing appear in the famous CKM matrix, the 3×3 unitary mixing matrix for the three quark families that is analogous to the 2×2 rotation matrix in Figure 8. In the Standard Model, the mismatch between quark mass states and weak states is responsible for all processes in which quarks transmute across families. Among those processes is the oscillation between the neutral kaon, K^0 ($s\bar{d}$), and its antiparticle, \bar{K}^0 ($\bar{s}d$). The kaons periodically change from particle to antiparticle during free flight in space. Figure 10 shows how oscillations can come about as the quark mass states composing the kaons interact through the W . The quarks transmute across family lines because they are mass states, each a mixture of weak states from all three weak families. Just as the mixing

between the quark weak and mass states results in the oscillation of the neutral kaon into its antiparticle, the oscillation of one neutrino flavor into another is possible only if there is mixing between lepton weak and mass states.

Nonmixing among Leptons and Lepton-Number Conservation Laws

To recap what we discussed earlier, in the usual version of the Standard Model, there is no mixing among the leptons. Because the three neutrinos are assumed to have the same mass (namely, zero), the lepton version of the CKM mixing matrix for quarks is the identity matrix. Thus, the mass states and weak states are equivalent, and there is no mechanism to produce reactions that will cross family lines. As with the quarks, the weak force always acts between the members of a weak doublet and simply transforms a muon into a muon neutrino and vice versa, or allows similar transformations for the other lepton families. A further assumption in the Standard Model is that, although electrically neutral, the left-handed neutrino and the right-handed antineutrino are distinct particles and cannot transmute into each other.

These theoretical assumptions lead directly to two types of lepton-number conservation laws: one for total lepton number (the number of leptons minus

the number of antileptons) and the other for individual-lepton-family number (the number of leptons minus the number of antileptons in a particular lepton family). Although these laws can be viewed as predictions of the Standard Model, they were deduced empirically a decade before the Standard Model was formulated. Let us review the relevant leptonic reactions and methods of interpretation because the same reactions are now being used to detect neutrino oscillations and to search for the consequences of nonzero neutrino masses.

Conservation of Total Lepton Number. The primary sources of neutrinos in cosmic-ray- and accelerator-based neutrino experiments are pion and muon decays. Pions⁶ come in three charge states, the π^+ , π^- , and π^0 .

Shortly after they are produced through the strong force, the charged pions decay into muons through the weak force:

$$\begin{aligned} \pi^+ &\rightarrow \mu^+ + \nu_\mu ; \\ \pi^- &\rightarrow \mu^- + \bar{\nu}_\mu . \end{aligned} \quad (4)$$

⁶The pion is a massive spin-0 particle made of quark-antiquark pairs from the first family. It is a carrier, or mediator, of the residual strong force that binds neutrons and protons inside nuclei. Pions are produced, or “boiled off,” in great numbers when nuclei are bombarded by energetic protons. Yukawa predicted the existence of this particle in the 1930s. When the muon, which is slightly less massive than the pion, was discovered in cosmic rays in 1937, it was at first mistakenly identified as Yukawa’s particle.

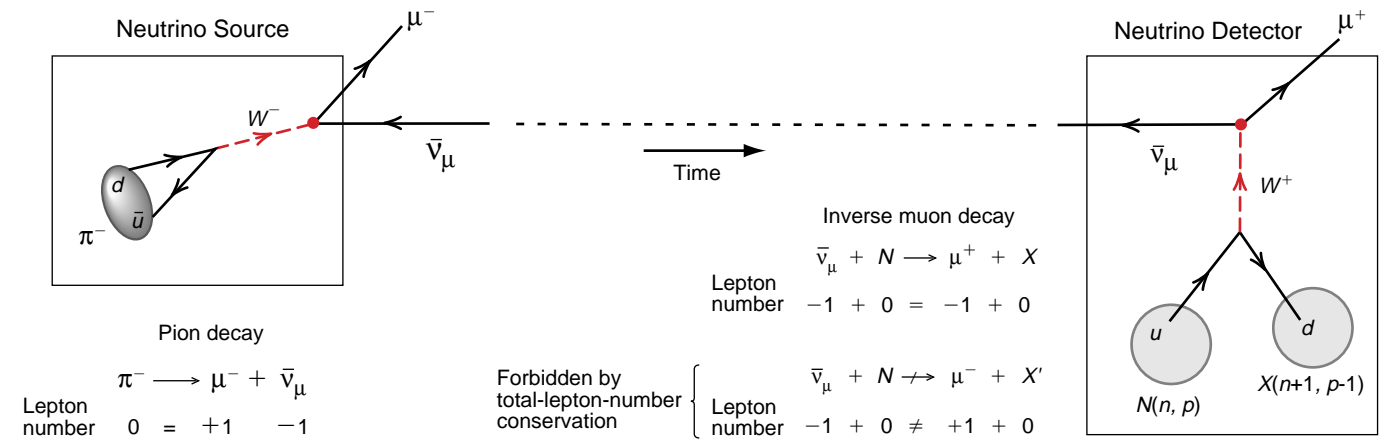

Figure 11. Test of Lepton-Number Conservation
 At left is a neutrino source consisting of muon antineutrinos ($L = -1$) from pion decay. If total lepton number is conserved, then as shown in the figure, those antineutrinos should interact with matter through inverse muon decay and produce antimuons ($L = -1$). They should never produce muons because that reaction would change the total lepton number by two units. Shown in the figure are the lepton numbers for pion decay and inverse muon decay as well as the reaction forbidden by total-lepton-number conservation.

The positive pion will decay to the antimuon and the negative pion to the muon because electric charge must be conserved. The law of total-lepton-number conservation says that the number of leptons minus the number of antileptons must not change in any reaction. To formalize this law, every particle is assigned a lepton number L . By convention, the negatively charged leptons are called leptons and assigned a lepton number of $+1$, and their positively charged counterparts are called antileptons and are assigned a lepton number of -1 (see Table I). Because quarks are not leptons, they are assigned a lepton number of zero.

Since the pion is also not a lepton (lepton number $L = 0$), its decay must produce one lepton and one antilepton ($L = 1 - 1 = 0$). Thus a ν_μ (lepton) is created with the μ^+ (antilepton), or a $\bar{\nu}_\mu$ (antilepton) is created with the μ^- (lepton). Conservation of total lepton number can easily be checked in all the processes shown in Figures 3 and 4.

How can one prove that the neutrino and antineutrino have different lepton numbers? How can one show that, for example, the neutrino from π^+ decay has lepton number $+1$, like the muon, whereas the antineutrino from π^- decay has lepton number -1 , like the antimuon? The test requires detecting the

Table I. Lepton Numbers and Lepton-Family Numbers

Particle	Lepton Number L	Electron-Family Number L_e	Muon-Family Number L_μ	Tau-Family Number L_τ
e^-	+1	+1	0	0
ν_e	+1	+1	0	0
e^+	-1	-1	0	0
$\bar{\nu}_e$	-1	-1	0	0
μ^-	+1	0	+1	0
ν_μ	+1	0	+1	0
μ^+	-1	0	-1	0
$\bar{\nu}_\mu$	-1	0	-1	0
τ^-	+1	0	0	+1
ν_τ	+1	0	0	+1
τ^+	-1	0	0	-1
$\bar{\nu}_\tau$	-1	0	0	-1

interaction of those neutrinos with matter. As shown in Figure 11, the antineutrino from π^- decay has lepton number -1 if it produces an antimuon ($L = -1$)—and never a muon—when interacting with matter. Likewise, the neutrino from π^+ decay has lepton number $+1$ if it produces a muon—never an antimuon.

Indeed, these tests have been performed, and conservation of total lepton number holds to a very high level of precision. (However, if neutrinos have a small nonzero mass and furthermore if they acquire that mass through what is called a Majorana mass term, neutrinos would be their own antiparticles. They

Figure 12. Is the Muon Neutrino the Same Particle as the Electron Neutrino?

Ordinary muon decay is shown in (a). At one weak-interaction vertex, a muon transmutes into a muon neutrino and emits a W^- , and at the second, the W^- decays into an electron and an electron antineutrino. Two neutrinos are produced, one associated with the muon and the other with the electron. (b) If the muon neutrino were the same as the electron neutrino, then the muon could decay to an electron through two weak-interaction vertices. At one vertex, the muon transforms into a neutrino and emits a W^- ; at the second vertex, that same neutrino absorbs a W^- and transmutes into an electron. To conserve energy and momentum, the (virtual) W^- radiates a photon. Thus, muon decay produces an electron and a gamma ray, but no neutrinos are emitted. In other words, the process $\mu^- \rightarrow e^- + \gamma$ could occur if the muon neutrino were the same as the electron neutrino.

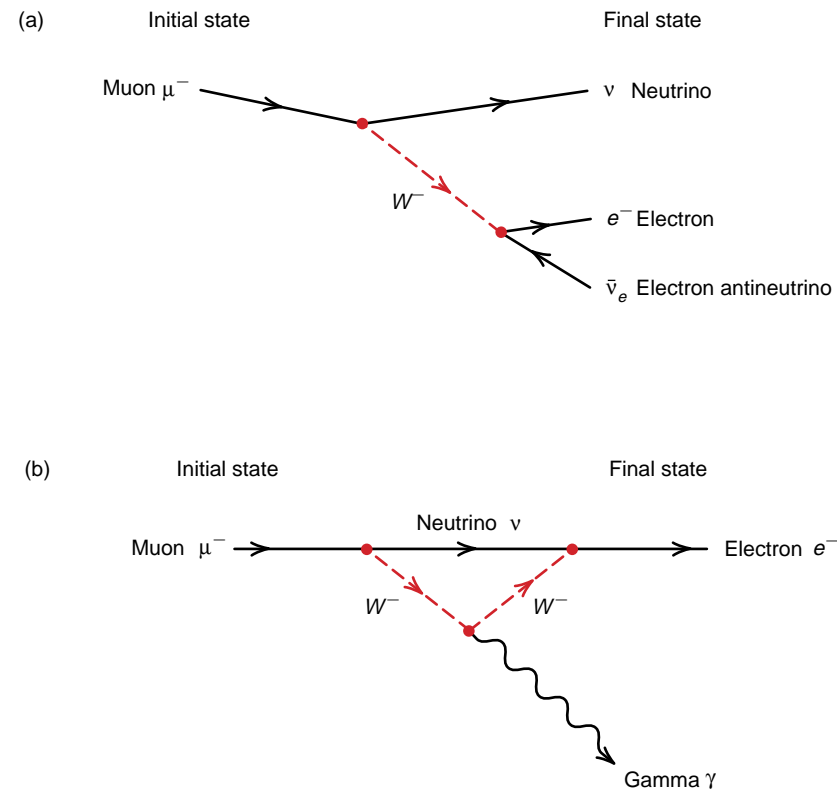

might induce, at some low rate, reactions that would change total lepton number. This possibility will be discussed later in the text.)

Conservation of Lepton-Family Number. One might also wonder how it was shown that the muon neutrino is really distinct from the electron neutrino and that distinct lepton families are under the weak force. Those discoveries came from studies of muon decay. In the late 1940s, the muon was observed to decay into an electron emitted with a spectrum of energies. As in ordinary beta decay, a spectrum of electron energies rather than a single energy means that the decay must yield three particles in the final state.

However, only the electron revealed its presence, so the two unidentified particles ($\mu^- \rightarrow e^- + ? + ?$) had to be electrically neutral. It was also observed that the rates of muon decay and muon capture by nuclei were very similar to the rates for beta decay and electron capture. The same weak force

outlined in Fermi's theory of beta decay seemed to be at work, and so the mechanism of muon decay was believed to be entirely analogous to that of neutron beta decay.

At that time, the local symmetry of the weak force was not known, but Fermi's theory did place particles in pairs that transformed into each other under the weak force. It was therefore assumed that the weak force transformed the muon into a neutral particle of some kind, perhaps the neutrino, and that, to conserve charge, an electron and an antineutrino were produced as in ordinary neutron beta decay:

$$\mu^- \rightarrow \nu + e^- + \bar{\nu}_e \quad (5)$$

Then, in the 1950s, theorists considered the possibility that a massive gauge boson (like the W) mediated the weak force, in which case the muon could decay to an electron through the two processes shown in Figure 12. The latter process involves not only the exchange of a virtual W but also the

exchange of a virtual neutrino that couples to both the electron and the muon. In other words, the muon transmutes into a neutrino, and then that same neutrino transmutes into an electron. Because there are three interaction vertices in the diagram for $\mu^- \rightarrow e^- + \gamma$, two weak and one electromagnetic, the rate for this second mode would be small but still observable, about 10^{-5} of the total decay rate of the muon. This decay mode, however, has never been observed. The MEGA (muon to electron plus gamma) experiment, currently nearing completion at Los Alamos, has put the most stringent upper limit on the rate of this process so far. It is less than 4×10^{-11} of the total muon-decay rate.

The absence of $\mu^- \rightarrow e^- + \gamma$ is a clue that there are two neutrino flavors—one strictly associated with the electron; the other, with the muon. In muon beta decay, for example, a muon transforms into a *muon* neutrino, and an electron and its antineutrino are created to conserve charge:

$$\mu^- \rightarrow \nu_\mu + e^- + \bar{\nu}_e \quad (6)$$

Likewise, in π^+ decay, the neutrino created with the antimuon is a *muon* neutrino ($\pi^+ \rightarrow \mu^+ + \nu_\mu$), not an electron neutrino. Thus, a second lepton family was thought to exist.

The conjecture of two neutrino flavors was tested by Leon Lederman, Mel Schwartz, and Jack Steinberger, who designed an ingenious experiment—analogue to the one illustrated in Figure 11—at the Brookhaven 30-giga-electron-volt (GeV) proton accelerator. As in most accelerator-neutrino experiments, a pulsed beam of protons is directed at a target, where they produce a myriad of pions that rapidly decay into muons and neutrinos.

In this case, the experimenters found a way to tailor a narrow beam of high-energy neutrinos from a much wider distribution. They allowed these high-energy neutrinos to pass through a huge spark chamber containing 10 tons of aluminum plates in parallel stacks separated by narrow gaps. A neutrino entering the spark chamber could interact with an aluminum nucleus and produce a high-energy muon or electron. Either one would leave an ionization track in the gas between the plates, and if the plates were charged, they would discharge along that track and create a trail of bright sparks that could easily be photographed. The experiment produced a total of 29 spark-chamber photographs containing long, straight tracks that started from within the spark chamber and were characteristic of an energetic muon. The erratic, staggered tracks that would be produced by the much lighter electron were essentially absent. Thus, the neutrino produced in π^+ decay could transform into a muon but not into an electron.

These results supported the idea of two independent neutrino flavors and led the way for establishing separate conservation laws for two new quantum numbers, muon-family number and electron-family number (refer again to

Table II. Decays Forbidden by Lepton-Family-Number Conservation Laws

$\mu^+ \rightarrow e^+ + \gamma$
$\mu^+ \rightarrow e^+ + e^- + e^+$
$\mu^- + N(n, p) \rightarrow e^- + N(n, p)$
$\mu^- + N(n, p) \rightarrow e^+ + N(n + 2, p - 2)$
$\mu^+ \rightarrow e^+ + \bar{\nu}_e + \nu_\mu$

Table I). These laws are analogous to the conservation laws of total lepton number except that they apply separately to the electron, electron neutrino, and their antiparticles on the one hand and to the muon, muon neutrino, and their antiparticles on the other.

To conserve muon-family number, a muon can turn into a muon neutrino—never into a particle with a muon number of zero. Similarly, to conserve electron number, an electron can turn into an electron neutrino; it cannot turn into a particle with an electron number of zero. Once the tau, the charged lepton of the third family, was discovered, the tau neutrino was assumed to exist, and tau-family number and its conservation were postulated.

At the beginning of this section, we stated that strict separation between the lepton families is implied by the gauge symmetry of the weak force, combined with the assumption that the three neutrinos are massless. But this assumption always seemed to rest on shaky ground. More important, new forces could exist, even weaker than the weak force, that have yet to be seen but that allow leptons to transmute across family lines. Consequently, there have been many searches for various “forbidden” reactions such as those listed in Table II. Searches for violations of the Standard Model have mostly reported null results. The exception is the LSND experiment, which reports that muon antineutrinos can oscillate into electron antineutrinos with a probability of about 0.3 percent

(averaged over the experimental energy and distances).

Neutrino Oscillations

The first suggestion that free neutrinos traveling through space might oscillate, that is, periodically change from one neutrino type to another, was made in 1957 by Bruno Pontecorvo. Gell-Mann and Pais had just shown how quantum mechanical interference would allow the neutral kaon K^0 ($s\bar{d}$) and its antiparticle \bar{K}^0 ($\bar{s}d$) to oscillate back and forth because the quark mass states are mixtures of weak states. Pontecorvo noted very briefly that, if the neutrino had mass and if total lepton number were not conserved, the neutrino could imitate the neutral kaon, oscillating between particle and antiparticle as it travels through empty space. This possibility would have implied that the neutrino is a massive Majorana particle with no definite distinction between particle and antiparticle forms.

Although very interesting and still relevant today, Pontecorvo's suggestion was not explored in 1957 because Lee and Yang's theory of the massless two-component neutrino was just gaining acceptance. This theory helped explain why parity was maximally violated in nuclear beta decay. The existence of a left-handed neutrino, distinct from the right-handed antineutrino by having the opposite lepton number, was a crucial postulate (see the box “Parity Nonconservation and the Massless Two-

Component Neutrino” on page 32). In that theory, particle-antiparticle oscillations could not occur.

Solar Neutrinos. In 1963, after Lederman, Steinberger, and Schwartz showed that there were two distinct flavors of neutrino, the idea of oscillation between electron neutrinos and muon neutrinos surfaced for the first time. This possibility requires mixing across the lepton families as well as nonzero neutrino masses. In 1969, it was decided that the idea of neutrino oscillation was worth testing. The Sun is known to drench us with low-energy electron neutrinos that are produced in the thermonuclear furnace at its core, as shown in Figure 13(a). By using standard astrophysics models about stellar processes and the observed value of the Sun’s luminosity, theorists can predict the size of the neutrino flux. But measurements of the solar-neutrino flux present an intriguing puzzle: A significant fraction of those electron neutrinos apparently disappear before reaching our terrestrial detectors. Ray Davis made the first observation of a neutrino shortfall at the Homestake Mine in South Dakota, and all experiments since have confirmed it. Today, the most plausible explanation of the solar-neutrino puzzle lies in the oscillation of electron neutrinos into other types of neutrinos. Although the measured shortfall is large and the expected amplitude of neutrino oscillations in a vacuum is small, neutrino oscillations can still explain the shortfall through the MSW effect.

Named after Mikheyev, Smirnov, and Wolfenstein, the MSW effect describes how electron neutrinos, through their interactions with electrons in solar matter, can dramatically increase their intrinsic oscillation probability as they travel from the solar core to the surface. This matter enhancement of neutrino oscillations varies with neutrino energy and matter density. The next generation of solar-neutrino experiments is specifically designed to explore whether the electron neutrino deficit has the energy

dependence predicted by the MSW effect (see the articles “Exorcising Ghosts” on page 136 and “MSW” on page 156).

Atmospheric Neutrinos. In 1992, another neutrino deficit was seen—this time in the ratio of muon neutrinos to electron neutrinos produced at the top of the earth’s atmosphere. When high-energy cosmic rays, mostly protons, strike nuclei in the upper atmosphere, they produce pions and muons, which then decay through the weak force and produce muon and electron neutrinos. The atmospheric neutrinos have very high energies, ranging from hundreds of million electron volts (MeV) to tens of giga-electron-volts, depending on the energy of the incident cosmic ray and on how this energy is shared among the fragments of the initial reaction. As shown in Figure 13(b), the decay of pions to muons followed by the decay of muons to electrons produces two muon neutrinos for every electron neutrino. But the measured ratio of these two types is much smaller (see the article “The Evidence for Oscillations” on page 116). The oscillation of muon neutrinos into tau neutrinos appears to be the simplest explanation.

Accelerator Neutrinos. The lone accelerator-based experiment with evidence for neutrino oscillations is LSND. This experiment uses the high-intensity proton beam from the linear accelerator at the Los Alamos Neutron Science Center (LANSCE) to generate an intense source of neutrinos with average energies of about 50 MeV. In 1995, the LSND collaboration reported positive signs of neutrino oscillations. An excess of 22 electron antineutrino events over background was observed. They were interpreted as evidence for the oscillation of muon antineutrinos, into electron antineutrinos (see Figure 13c). The muon antineutrinos had been produced at the accelerator target through antimuon decay-at-rest. As in the experiments described earlier to study electron-

family-number and muon-family-number conservation laws, the electron antineutrino was detected through its charged-current interaction with matter, that is, through inverse beta decay.

Recently, members of the LSND collaboration reported a second positive result. This time, they searched for the oscillation of muon neutrinos rather than muon antineutrinos. The muon neutrinos are only produced during pion decay-in-flight, before the pions reach the beam stop. Therefore, these neutrinos have a higher average energy than the muon antineutrinos measured in the earlier experiment. The muon neutrinos were observed to turn into electron neutrinos at a rate consistent with the rate for antineutrino oscillation reported earlier. Since the two experiments involved different neutrino energies and different reactions to detect the oscillations, the two results are indeed independent. The fact that the two results confirm one another is therefore most significant. The complete story of LSND can be found in the article “A Thousand Eyes” on page 92.

Each type of experiment shown in Figure 13, when interpreted as an oscillation experiment, yields information about the oscillation amplitude and wavelength. One can therefore deduce information about the sizes of neutrino masses and lepton-family mixing parameters. The specific relationships are explained in the next section.

The Mechanics of Oscillation

Oscillation, or the spontaneous periodic change from one neutrino mass state to another, is a spectacular example of quantum mechanics. A neutrino produced through the weak force in, say, muon decay, is described as the sum of two matter waves. As the neutrino travels through space (and depending on which masses are measured), these matter waves interfere with each other constructively or destructively. For example, the interference causes first the disappearance and

Figure 13. Three Types of Evidence for Neutrino Oscillations

(a) Solar neutrinos—a disappearance experiment. The flux of electron neutrinos produced in the Sun’s core was measured in large underground detectors and found to be lower than expected. The “disappearance” could be explained by the oscillation of the electron neutrino into another flavor.

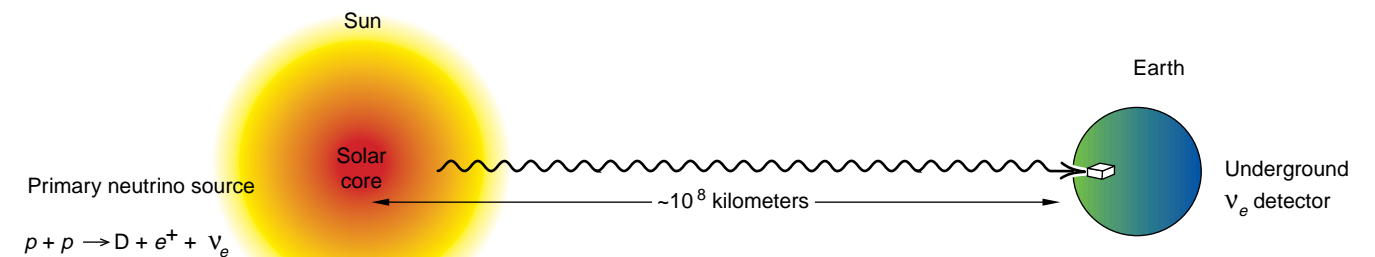

Other sources of neutrinos:
 $e^- + {}^7\text{Be} \rightarrow {}^7\text{Li} + \nu_e$
 ${}^8\text{B} \rightarrow 2 {}^4\text{He} + e^+ + \nu_e$

(b) Atmospheric neutrinos—a disappearance experiment. Collisions between high-energy protons and nuclei in the upper atmosphere can create high-energy pions. The decay of those pions followed by the decay of the resulting muons produces twice as many muon-type neutrinos (blue) as electron-type neutrinos (red). But underground neutrino detectors designed to measure both types see a much smaller ratio than 2 to 1. The oscillation of muon neutrinos into tau neutrinos could explain that deficit.

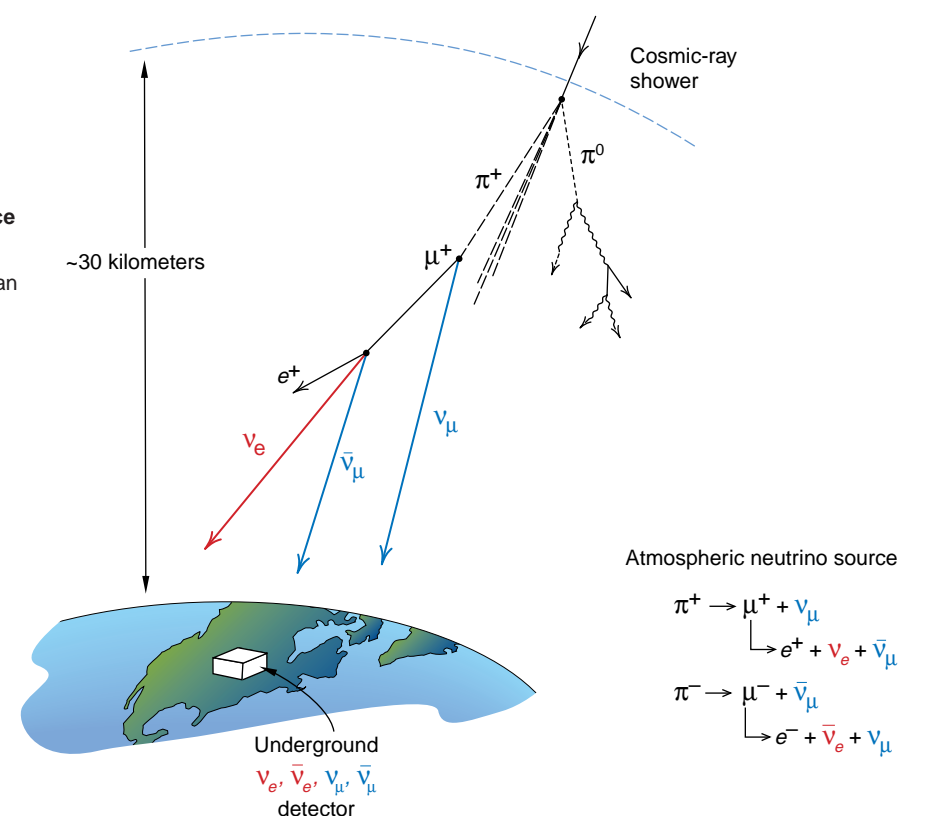

(c) LSND—an appearance experiment. Positive pions decay at rest into positive muons, which then decay into muon antineutrinos, positrons, and electron neutrinos. Negative pions decay and produce electron antineutrinos, but that rate is almost negligible. A giant liquid-scintillator neutrino detector located 30 meters downstream looks for the appearance of electron antineutrinos as the signal that the muon antineutrinos have oscillated into that flavor.

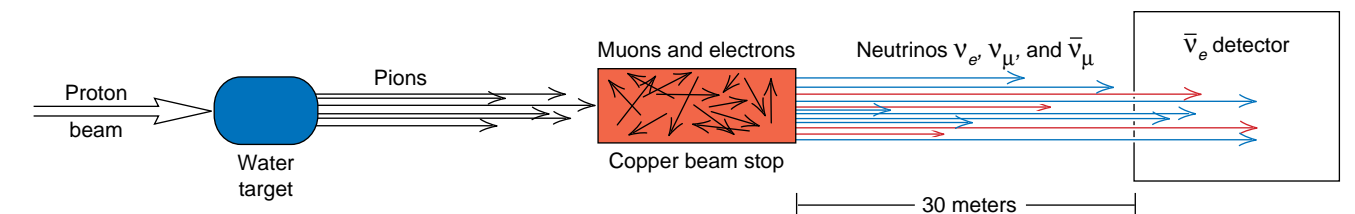
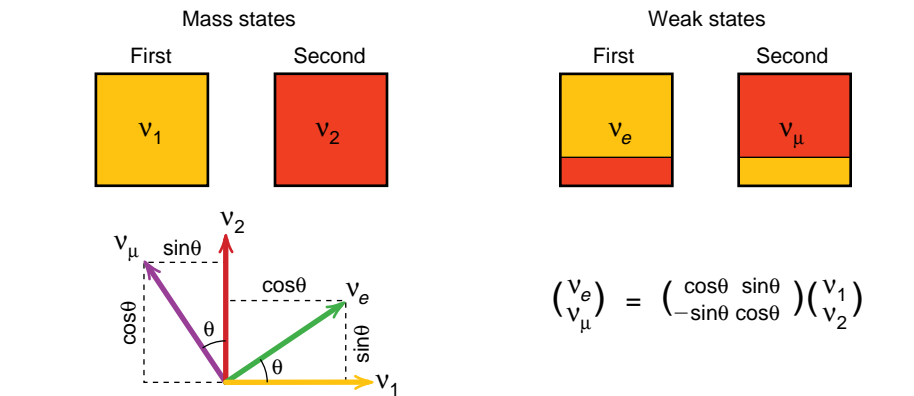

Figure 14. Neutrino Oscillations in the Two-Family Context

a) Neutrino mass states and weak states.

The weak states ν_e and ν_μ are shown as color mixtures of the mass states ν_1 (yellow) and ν_2 (red), and the mixing matrix that rotates ν_1 and ν_2 into ν_e and ν_μ is shown below the weak states. Each set of states is so represented as a set of unit vectors in a plane. The two sets are rotated by an angle θ relative to each other.



b) Time evolution of the muon neutrino.

The ν_μ is produced at $t = 0$ as a specific near combination of mass states:

$\nu_\mu = -\sin\theta \nu_1 + \cos\theta \nu_2$. The amplitude of each mass state is shown oscillating in time with a frequency determined by the energy of that mass state. The energies of the two states are different because their masses are different, $m_1 \neq m_2$. Each time the two mass states return to the original phase relationship at $t = 0$, they compose a pure ν_μ . At other times, the two mass states have different phase relationship and can be thought of as a mixture of ν_μ and ν_e .

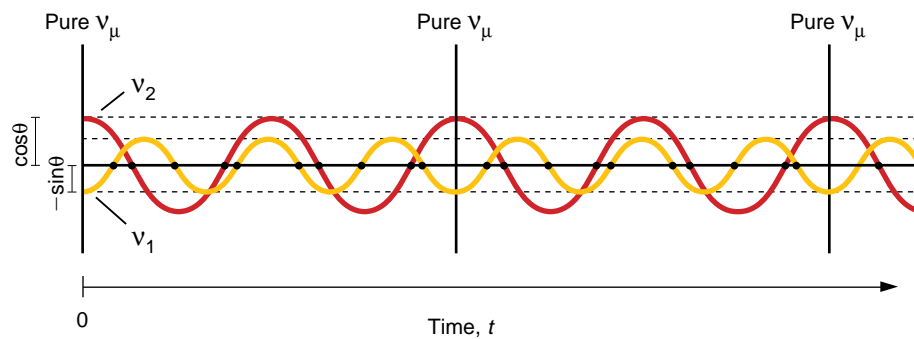

c) Neutrino oscillation.

Because the two mass components interfere with each other, the probability of finding a muon neutrino (purple) oscillates with distance from the source. The probability of finding an electron neutrino in its place also oscillates, and in the two-family approximation, the sum of the probabilities is always 1. The wavelength of this oscillation λ_{osc} increases as the masses of the two neutrinos get closer in value.

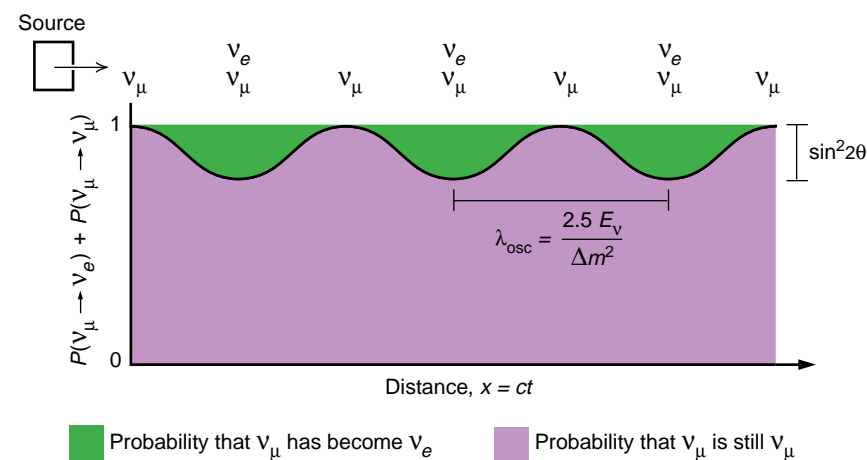

on the reappearance of the original type of neutrino. The interference can occur only if the two matter waves have different masses. Thus, the mechanics of neutrino oscillation start from the assumption that the weak and mass states are not the same and that one set is composed of mixtures of the other set in a manner entirely analogous to the descriptions of the quark weak and mass states in Figure 8. In other words, there must be mixing among the leptons as there is among the quarks.

In the examples of quark mixing described earlier, the quarks within the composite particles (proton, neutron, lambda) start and end as pure mass states, and the fact that they are mixtures of weak states shows up through the action of the weak force. When a neutron decays through the weak force and the d quark transforms into a u , only a measurement of the decay rate reflects the degree to which a d quark is composed of the weak state d' . In contrast, in neutrino oscillation experi-

ments, the neutrinos always start and end as pure weak states. They are typically created through weak-force processes of pion decay and muon decay, and they are typically detected through inverse beta decay and inverse muon decay, weak processes in which the neutrinos are transmuted back to their charged lepton partners. Between the point of creation and the point of detection, they propagate freely, and if they oscillate into a weak state from a different family, it is not through the

action of the weak force, but rather through the pattern of interference that develops as the different mass states composing the original neutrino state evolve in time.

To see how the oscillation depends on the masses of the different neutrino mass states as well as the mixing angles between the lepton families, we limit the discussion to the first two families and assign the mixing to the electron neutrino and the muon neutrino (the halves of the lepton weak doublets with $I_3^w = 1/2$, as shown in Figure 5). Instead of expressing the mass states in terms of the weak states, as was done in Equation (3), we can use the alternate point of view and express the neutrino weak states $|\nu_e\rangle$ and $|\nu_\mu\rangle$ as linear combinations of the neutrino mass states $|\nu_1\rangle$ and $|\nu_2\rangle$ with masses m_1 and m_2 , respectively (where we have assumed that m_1 and m_2 are not equal).

Figure 14(a) illustrates this point of view. It shows how the weak states and mass states are like alternate sets of unit vectors in a plane that are related to each other by a rotation through an angle θ . The rotation, or mixing, yields the following relationships:

$$\begin{aligned} |\nu_e\rangle &= \cos\theta|\nu_1\rangle + \sin\theta|\nu_2\rangle; \\ |\nu_\mu\rangle &= -\sin\theta|\nu_1\rangle + \cos\theta|\nu_2\rangle. \end{aligned} \quad (7)$$

The mixing angle θ is the lepton analog of the Cabibbo mixing angle for the quarks. If θ is small, then $\cos\theta$ is close to 1, and the electron neutrino is mostly made of the state with mass m_1 , whereas the muon neutrino is mostly made of the state with mass m_2 . If the mixing angle is maximal (that is, $\theta = \pi/4$, so that $\cos\theta = \sin\theta = 1/\sqrt{2}$), each weak state has equal amounts of the two mass states.

To see how oscillations can occur, we must describe the time evolution of a free neutrino. Consider a muon neutrino produced by the weak force at $t = 0$. It is a linear combination of two mass states, or matter waves, that are, by the convention in Equation (7) exactly 180 degrees out of phase with

one another. In quantum mechanics, the time evolution of a state is determined by its energy, and the energies of the mass states are simply given by

$$E_k = \sqrt{p^2c^2 + m_k^2c^4}, \quad (8)$$

where p is the momentum of the neutrinos and m_k ($k = 1, 2$) is the mass of the states ν_1 and ν_2 , respectively. Note that, if the particle is at rest, this is just the famous energy relation of Einstein's special relativity, $E = mc^2$. In quantum mechanics, the time evolution of each mass component ν_k is obtained by multiplying that component by the phase factor $\exp[-i(E_k/\hbar)t]$, and thus the time evolution of the muon neutrino is given by

$$|\nu_\mu(t)\rangle = -\sin\theta \exp[-i(E_1/\hbar)t]|\nu_1\rangle + \cos\theta \exp[-i(E_2/\hbar)t]|\nu_2\rangle \quad (9)$$

as discussed in the box "Derivation of Neutrino Oscillations" on the next page. Because the two states $|\nu_1\rangle$ and $|\nu_2\rangle$ have different masses, they also have different energies (E_1 is not equal to E_2), and the two components evolve with different phases.

Figure 14(b) plots the wavelike behavior of each of the mass components (red and yellow) and shows how the relative phase of the two components varies periodically in time. At $t = 0$, the two components add up to a pure muon neutrino (a pure weak state), and their relative phase is π . As their relative phase advances in time, the mass components add up to some linear combination of a muon neutrino $|\nu_\mu\rangle$ and an electron neutrino $|\nu_e\rangle$, and when the relative phase has advanced by 2π , the components add back up to a muon neutrino. The relative phase oscillates with a definite period, or wavelength, that depends on the difference in the energies of the two mass components, or equivalently, the squared mass differences, $\Delta m^2 = m_1^2 - m_2^2$.

In quantum mechanics, observations pick out the particle rather than the wave aspects of matter, and in the case of neutrinos, they pick out the weak-

interaction properties as opposed to the free-propagation characteristics of mass and momentum. So, in an individual measurement of an event, there are only two possibilities: to detect the muon neutrino or the electron neutrino, but not some linear combination. Thus, what is relevant for an experiment is the probability that the muon neutrino remains a muon neutrino at a distance x from its origin, $P(\nu_\mu \rightarrow \nu_\mu)$, or the probability that the muon neutrino has transformed into an electron neutrino, $P(\nu_\mu \rightarrow \nu_e)$. The box "Derivation of Neutrino Oscillations" on the next page shows how to calculate these probabilities from the time-evolved state. The results are

$$P(\nu_\mu \rightarrow \nu_\mu) = 1 - \sin^2 2\theta \sin^2\left(\frac{\pi x}{\lambda_{osc}}\right) \quad (10)$$

and

$$P(\nu_\mu \rightarrow \nu_e) = \sin^2 2\theta \sin^2\left(\frac{\pi x}{\lambda_{osc}}\right), \quad (11)$$

where θ is the mixing angle defined above, x is measured in meters, and λ_{osc} is the oscillation length given in meters. The oscillation length (the distance between two probability maxima or two probability minima) varies with the energy of the neutrino E_ν (in million electron volts), and it also depends on the squared mass difference (in electron volts squared):

$$\lambda_{osc} = 2.5 E_\nu / \Delta m^2, \quad (12)$$

The two probabilities in Equations (10) and (11) oscillate with distance x from the source, as shown in Figure 14(c).

To summarize, a muon neutrino produced at $t = 0$ travels through space at almost the speed of light c . As time passes, the probability of finding the muon neutrino $P(\nu_\mu \rightarrow \nu_\mu)$ decreases below unity to a minimum value of $1 - \sin^2 2\theta$ and then increases back to unity. This variation has a periodicity over a characteristic length $\lambda_{osc} \equiv cT$, where T is the period of neutrino oscillation. The oscillation length varies inversely with Δm^2 . The probability of finding an electron neutrino in place

Derivation of Neutrino Oscillations

Some simple algebra can show how neutrino oscillation effects depend on the mass difference of the neutrino mass eigenstates. Consider the simplified case of just two neutrino flavors. We express the quantum mechanical wave function for a muon neutrino produced at $t = 0$ as a mixture of the mass eigenstates $|\nu_1\rangle$ and $|\nu_2\rangle$ with masses m_1 and m_2 , respectively.

$$|\nu_\mu(0)\rangle = |\nu_\mu\rangle = -\sin\theta |\nu_1\rangle + \cos\theta |\nu_2\rangle ,$$

where an electron neutrino is given by $|\nu_e\rangle = \cos\theta |\nu_1\rangle + \sin\theta |\nu_2\rangle$ and the angle θ characterizes the extent of mixing of the mass eigenstates in the weak-interaction eigenstates. It is called the mixing angle. (For more than two flavors, there are more mixing angles as well as charge-conjugation and parity, CP, violating phases.) At a later time t , the wave function is

$$|\nu_\mu(t)\rangle = -\sin\theta \exp(-iE_1 t) |\nu_1\rangle + \cos\theta \exp(-iE_2 t) |\nu_2\rangle ,$$

where the mass eigenstates propagate as free particles and E_1 and E_2 are the energies of those states $|\nu_1\rangle$ and $|\nu_2\rangle$, respectively. (We are working in units for which $\hbar = c = 1$.) For relativistic neutrinos ($E_\nu \gg m$), we can approximate E_1 and E_2 by

$$E_k = (p^2 + m_k^2)^{1/2} \cong p + m_k^2/2p ,$$

where we are assuming that the two mass states have the same momentum. After substituting these energies, the wave function at time t becomes

$$|\nu_\mu(t)\rangle = \exp[-it(p + m_1^2/2E_\nu)] [-\sin\theta |\nu_1\rangle + \cos\theta |\nu_2\rangle \exp(i\Delta m^2 t/2E_\nu)] ,$$

where $\Delta m^2 = m_1^2 - m_2^2$ and $E_\nu \cong p$. Since these neutrinos are traveling almost at the speed of light, we can replace t by $x/c = x$, where x is the distance from the source of muon neutrinos. Let us now calculate $P(\nu_\mu \rightarrow \nu_e)$, which is defined as the probability of observing a ν_e at x , given that a ν_μ was produced at the origin $x = 0$. The probability is the absolute square of the amplitude $\langle \nu_e | \nu_\mu(t) \rangle$. Using the orthonormality relation $\langle \nu_i | \nu_j \rangle = \delta_{ij}$, we can compute the probability

$$\begin{aligned} P(\nu_\mu \rightarrow \nu_e) &= |\cos\theta \sin\theta (1 - \exp(i\Delta m^2 t/2E_\nu))|^2 \\ &= \sin^2 2\theta \sin^2(\Delta m^2 x/4E_\nu) \\ &= \sin^2 2\theta \sin^2\left(\frac{1.27\Delta m^2 x}{E_\nu}\right) , \end{aligned}$$

where Δm^2 is measured in electron volts squared, x is in meters, and E_ν is in million electron volts, and the factor of 1.27 derives from working in these units. $P(\nu_\mu \rightarrow \nu_e)$ is the probability of observing a ν_e at x , given that a ν_μ is produced at $x = 0$. This probability can be computed explicitly, or by the conservation of probability, it is

$$P(\nu_\mu \rightarrow \nu_e) = 1 - \sin^2 2\theta \sin^2\left(\frac{1.27\Delta m^2 x}{E_\nu}\right) .$$

It is often useful to define an oscillation length, λ_{osc} for these probabilities, which, as shown in Figure 14(c), equals the distance between the maxima (or the minima). Note that the spatial period of $\sin^2 x$ is one-half that of $\sin x$, and so the oscillation length is defined by the following equation:

$$P(\nu_\mu \rightarrow \nu_e) = \sin^2 2\theta \sin^2\left(\frac{1.27\Delta m^2 x}{E_\nu}\right) = \sin^2 2\theta \sin^2\left(\frac{\pi x}{\lambda_{\text{osc}}}\right) ,$$

where

$$\lambda_{\text{osc}} = \frac{\pi E_\nu}{1.27\Delta m^2} \cong \frac{2.5E_\nu}{\Delta m^2} .$$

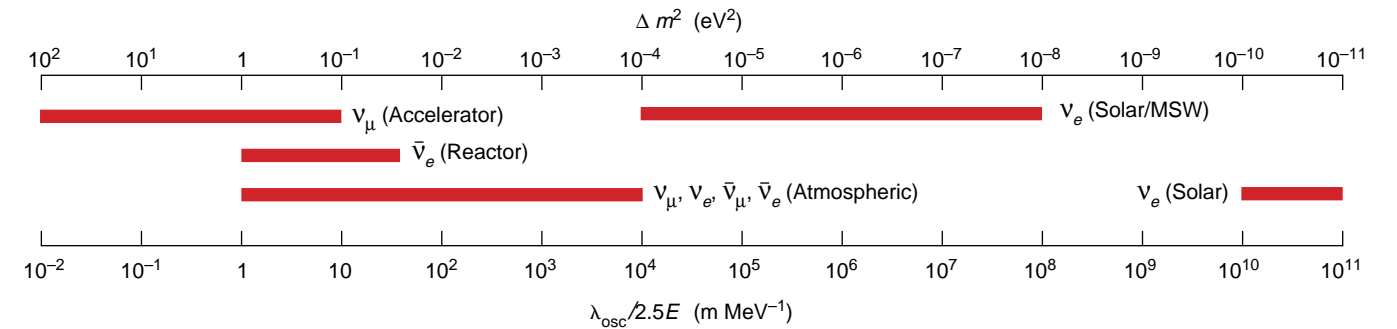

Figure 15. Accessible Ranges of Δm^2

Neutrino energies are specific to the source, and source-to-detector distances also vary with the source. The ratio of these two variables determines the range of values for Δm^2 that neutrino oscillation experiments can measure using each source. These ranges are labeled with the source and the neutrinos produced by that source. Two ranges are given for solar-neutrino experiments. One assumes that the MSW effect enhances oscillations, in which case, the range of Δm^2 is determined in part by the electron density of matter in the Sun. The other assumes no matter enhancement.

of the muon neutrino $P(\nu_\mu \rightarrow \nu_e)$ also oscillates as a function of distance from the source and has the same wavelength λ_{osc} . That probability has a maximum value of $\sin^2 2\theta$. These formulas show explicitly that, if neutrinos oscillate between family types, neutrinos must have nonzero masses and the neutrino weak states are not states of definite mass but rather mixtures of mass states.

Although we have restricted the analysis to mixing between two families, there is every reason to expect that, if mixing takes place among the leptons, it would occur among all three families and that there would be a mixing matrix for the leptons analogous to the CKM matrix for the quarks. The three-flavor mixing problem is more difficult, but it boils down to carrying out the analysis, which is a technical problem.

Interpreting Oscillation Experiments

Most extensions of the Standard Model tell us to expect mixing among leptons in analogy with mixing among quarks. But so far, those theories make no quantitative predictions on masses and mixing angles. Thus, neutrino oscillation experiments have a twofold purpose: first to establish convincing evidence for oscillations and then to

make quantitative determinations of the neutrino masses and mixing angles.

Among the quarks, the amount of mixing is small and occurs primarily between the first two families. It is natural to assume the same should hold for the leptons, although theory provides no such restriction. Consequently, neutrino oscillation experiments have traditionally been interpreted in the two-family context. Applying the two-family formalism to each experiment allows one to derive a range of possible values for Δm^2 and a range for $\sin^2 2\theta$, where θ is the mixing angle between the two families. Input to the interpretation includes the neutrino energies in a particular experiment, the distance from source to detector, the expected neutrino flux, and the measured flux or probability. In a disappearance experiment, one measures $P(\nu_i \rightarrow \nu_i)$, the probability of finding the original neutrino flavor ν_i , where $i = e, \mu, \tau$. In an appearance experiment, one measures the probability of finding a flavor different from the original $P(\nu_i \rightarrow \nu_j)$, where $i \neq j$.

The only definite constraints on neutrino masses are the following upper limits: $\nu_e < 10$ electron volts (eV), derived from tritium beta decay, $\nu_\mu < 170$ kilo-electron-volts (keV), derived from pion decay, and $\nu_\tau < 24$ MeV, derived from tau decay. So, the field is wide open for exploration.

Figure 15 shows the regions of Δm^2 (and its inverse, $\lambda_{\text{osc}}/2.5E_\nu$) that can be probed with the neutrinos from reactors, accelerators, the upper atmosphere, and the Sun. Variations in neutrino energies and source-to-detector distances make each type of experiment sensitive to a different range of values. The largest mass difference accessed by solar-neutrino experiments (assuming the MSW effect) is below the lowest value accessed by other experiments. Given the electron densities in the Sun and the energies of solar neutrinos (1 to 10 MeV), MSW enhancement can take place only for very small values of Δm^2 from 10^{-4} to 10^{-9} eV², with a favored value on the order of 10^{-5} eV². So, if neutrino oscillation is the explanation behind the solar- and atmospheric-neutrino deficits as well as the LSND appearance measurements, the two-family analysis must be extended to three families. All the data supporting neutrino oscillations are reviewed in the article “The Evidence for Oscillations” on page 116.

We will give one simple example of a model that fits the oscillation data consistently, but there are many other such models with no way to choose among them. This simple model assumes the traditional mass hierarchy, $m_1 < m_2 < m_3$. But the first two masses, m_1 and m_2 , are assumed to be very nearly identical and therefore almost

qually distant from the third mass m_3 :

$$\begin{aligned} \Delta m_{12}^2 &\approx 10^{-5} \text{ (eV)}^2 \\ \Delta m_{23}^2 &\approx 0.3 \text{ (eV)}^2 \\ \Delta m_{13}^2 &\approx 0.3 \text{ (eV)}^2 \end{aligned} \quad (12)$$

Thus, there are two distinct oscillation lengths differing by 4 orders of magnitude. Since the upper limit on the electron neutrino mass is 10 eV, all neutrinos in this model would be very light and nearly degenerate in mass. The model also assumes that the mixing angle between the second and third families is close to the maximum value of $\pi/4$, whereas the mixing angles between the first two families and the first and third families are quite small. Note that this mixing pattern is quite unlike the CKM matrix for the quarks, in which the mixing angle for the second and third families is very small.)

Both LSND and solar-neutrino experiments measure the oscillation of the muon neutrino to the electron neutrino $P(\nu_\mu \rightarrow \nu_e)$, or vice versa, so one might naively assume that both measure Δm_{12}^2 , the difference between neutrino masses in the first and second families. But the LSND results for Δm^2 differ by at least 4 orders of magnitude from the solar results. How can the two be reconciled? The resolution comes about because mixing occurs among the three families. Then, three oscillatory terms can contribute to $P(\nu_\mu \rightarrow \nu_e)$, one with an oscillation length determined by Δm_{12}^2 and two others with oscillation lengths determined by Δm_{13}^2 and Δm_{23}^2 , respectively.

The source-to-detector distance (30 meters), combined with the neutrino energies, makes LSND sensitive to the two terms whose oscillations are determined by Δm_{13}^2 and Δm_{23}^2 . Those $\nu_\mu \leftrightarrow \nu_e$ oscillations take place indirectly through ν_τ . These “indirect oscillations” do not contribute to the solar-neutrino deficit because the wavelengths determined by Δm_{13}^2 and Δm_{23}^2 are too large. The resulting oscillation cannot be amplified by the MSW effect. Instead, the solar electron neutrinos

oscillate directly to muon neutrinos with no involvement of tau neutrinos. Although the intrinsic amplitude for this process is very small (small mixing angle θ_{12}), the amplitude is enhanced by the MSW effect. Solar experiments are thus a measure of Δm_{12}^2 . That mass difference is quite small, corresponding to a long oscillation length, and it therefore does not contribute to the LSND results.

Finally, atmospheric-neutrino oscillations are explained by muon neutrinos oscillating into tau neutrinos, a pathway dominated by Δm_{23}^2 and a large mixing angle. This consistent set of mixing angles and mass differences for the neutrinos was outlined by Cardall and Fuller (1996). The specifics of their solution are not as important as the fact that neutrino oscillations could explain the results coming from solar, atmospheric, and accelerator neutrino experiments.

What If Neutrinos Have Mass?

As data accumulate and the evidence for oscillations grows stronger, it is appropriate to examine the implications of lepton mixing. In terms of weak-interaction physics, individual-lepton-family number would no longer be strictly conserved, and the forbidden processes listed earlier could occur. Figure 16 illustrates how the oscillation of a muon neutrino into an electron neutrino would facilitate the process $\mu^- \rightarrow e^- + \gamma$. Unfortunately, the predicted rate for the process in Figure 16, in which the mixing occurs through neutrino interactions with the Higgs background, is far below the limit of detectability, about 10^{-40} times the rate of ordinary muon decay.⁷ More generally, lepton-family mixing through interaction with the Higgs bosons would parallel the mixing seen among quarks and lend further support to the idea presented in the Grand Unified Theories that quarks and leptons are close relatives.

In terms of the neutrino itself, oscillations would imply nonzero neutrino

masses, and therefore the basic description of the neutrino would have to be altered. The neutrino might be a Dirac particle and parallel the Dirac electron in having four independent states—right-handed and left-handed particle states, ν_R and ν_L , and right-handed and left-handed antiparticle states, $\bar{\nu}_R$ and $\bar{\nu}_L$. To complete this set of four, two new neutrino states would have to be added to the Standard Model: the right-handed neutrino ν_R and the left-handed antineutrino $\bar{\nu}_L$. The new states would be “sterile” in the sense that they would not interact through the weak force (or any other known force except gravity), and they would be included in the theory only as necessary ingredients to give the Dirac neutrino a mass.

Those sterile neutrino states, however, could differ in mass from the ordinary neutrino states that couple to the W , in which case the ordinary neutrinos could oscillate into those sterile, noninteracting forms. That possibility could have an impact in various astrophysical and cosmological contexts, and conversely, cosmological arguments would place limits on the existence of such sterile neutrinos.

On the other hand, the neutrino might be a Majorana particle, which, by definition, has just two particle states. The two observed states (left-handed neutrino ν_L and right-handed antineutrino $\bar{\nu}_R$) would be the full set. But they would have a new property that would make them freaks in the pantheon of elementary spin-1/2 particles—they could transform into each other and, in effect, would be their own antiparticles. As a result, the weak force could transform an electron into a left-handed electron neutrino, as usual, but then that left-handed neutrino could later appear as a *right-handed antineutrino* and interact through the weak force to

⁷Perhaps new forces, such as those expected in supersymmetric theories, also cause transitions between families and contribute to the process $\mu \rightarrow e + \gamma$. For a discussion of how new forces could contribute to muon decay, see the article “The Nature of Muon Decay and Physics beyond the Standard Model” on page 128.

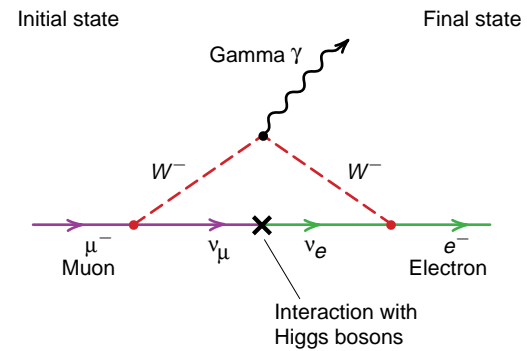

Figure 16. Example of Lepton-Family Mixing

If neutrinos have mass and lepton-family number is not conserved, a muon neutrino ν_μ emitted at the first weak-interaction vertex could become an electron neutrino ν_e through interaction with the Higgs background and be transmuted into an electron e^- at the second vertex. Thus, the reaction $\mu^- \rightarrow e^- + \gamma$ could proceed if mixing occurred across lepton families.

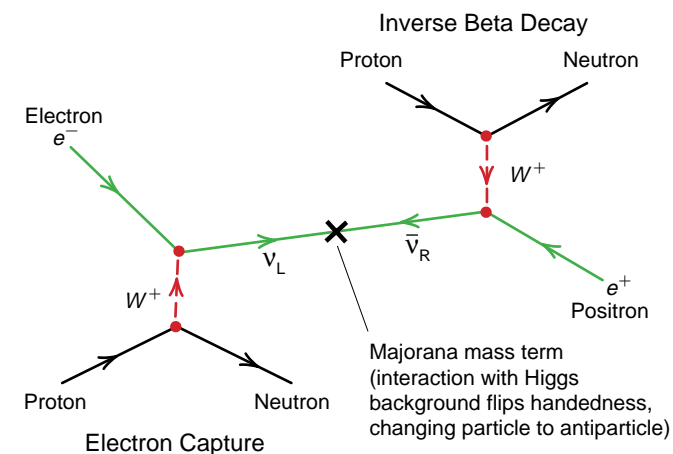

Figure 17. Example of Lepton-Number Nonconservation

If neutrinos are Majorana particles, a left-handed neutrino emitted in electron capture could become a right-handed antineutrino and create a positron through inverse beta decay. Such a process would change lepton number by two units. Notice that the left-handed neutrino flips its handedness through interaction with the Higgs background. This example of lepton-number violation should be compared with the example of lepton-number conservation in Figure 11.

become a positron. Such particle-antiparticle transitions would violate the law of total-lepton-number conservation as well as individual-family-number conservation (see Figure 17). They would also make possible a new type of beta decay known as neutrinoless double beta decay. Unfortunately, that process may be the only measurable sign that the neutrino is a Majorana rather than a Dirac particle.

If it is so hard to tell the types of neutrinos apart at low energies, why

should one care one way or the other? First, if neutrinos were Majorana particles, there would be no new low-mass neutrino states, and the number of mass and mixing-angle parameters in the theory would be highly restricted. This, in turn, would put strong constraints on any theoretical fit to the neutrino oscillation data. Second, the difference between Majorana and Dirac neutrinos is directly related to how neutrinos acquire mass. Grand Unified Theories and most

other extensions to the Standard Model suggest that the familiar neutrinos are Majorana particles and that they have very heavy relatives that reduce their masses through, what is sometimes called, the seesaw mechanism (explained later in this article).

Handedness versus Helicity. To elaborate further on these issues, we must consider the esoteric concept of handedness, a two-valued quantity related in a nontrivial way to helicity. Helicity and handedness are identical for massless particles and almost identical for massive particles, those traveling close to the speed of light. But the concept of handedness is crucial because (1) the weak force of the W distinguishes between different values of handedness and (2) the origin of particle masses and the fundamental differences between Dirac and Majorana neutrinos also involve the concept of handedness.

Figure 18 displays the helicity and handedness states of the electron and the massless electron neutrino as they appear in the Standard Model. Helicity is easy to describe. It is the polarization, or projection, of a particle’s intrinsic spin along its direction of motion. There are two such states: spin along the direction of motion (right helicity, or motion like a right-handed corkscrew) and spin opposite to the direction of motion (left helicity, or motion like a left-handed corkscrew). A particle can be produced in a state of definite helicity, and because angular momentum is conserved, that state can be measured directly. The problem is that, for particles with mass, helicity is not a relativistically invariant quantity: As shown in the cartoon on page 57, if neutrinos have mass, then their helicity can change with the reference frame.

In contrast, handedness (also called chirality), although harder to define without using the Dirac equation for spin-1/2 particles, provides a relativistically invariant description of a particle’s spin states. There are two independent handedness states for

spin-1/2 particles—left and right. A purely left-handed state has $N_x = L$, a purely right-handed state has $N_x = R$, and like lepton number and electric charge, a particle's handedness is independent of the reference frame from which it is viewed. Further, a particle, massless or massive, can be

decomposed into two independent components, left-handed and right-handed, and this decomposition does not change with the reference frame.

The confusing thing about handedness is that it is not a constant of the motion; a spin-1/2 particle traveling through space can change its

handedness without changing its helicity. Nevertheless, because it is relativistically invariant, handedness is an essential quantity for describing the properties of the weak force and the origin of particle masses, as well as particle properties. For example, when we say that interactions involving the W are

left-handed, we mean that they pick out the left-handed components of particles and the right-handed components of antiparticles. The correct Standard Model description of the weak isospin doublets, therefore, includes handedness labels. In the first family, the left-handed electron e_L and the left-handed electron neutrino ν_{eL} form a weak isospin doublet. The right-handed electron e_R exists but does not interact with the W , and it is therefore called a weak isospin singlet (that is, it is a scalar quantity under the weak isospin symmetry, and its weak isotopic charge is zero). The right-handed electron does couple electromagnetically to the photon and weakly to the Z^0 .

The right-handed (right-helicity) neutrino ν_{eR} does not exist in the Standard Model, but if included, it would be a weak isospin singlet and thus sterile in the sense already described. Similarly, because the weak force picks out the right-handed components of antiparticles, the right-handed positron \bar{e}_R and the right-handed electron antineutrino $\bar{\nu}_{eR}$ form a weak isospin doublet. The left-handed positron \bar{e}_L is a weak isospin singlet and has no weak isotopic charge. Table III lists the weak isospin doublets, the weak isospin singlets, and their charges for the first family of weak states in the Standard Model. The charges of the Higgs doublet h^0 and h^+ are also listed. (The Higgs doublet is discussed in the sidebar “Neutrino Masses” on page 64.)

Handedness is also a crucial concept for the discussion of neutrinos masses. It can be shown mathematically that any interaction or mechanism that gives spin-1/2 particles a nonzero rest mass must connect particles of different handedness, that is, the interaction must annihilate a particle of one handedness and create a particle of the opposite handedness. Thus, a particle with mass may switch between right- and left-handed states as it travels through space, changing its handedness by two units, whereas a massless particle undergoes no such transformation and maintains both its handedness and helicity.

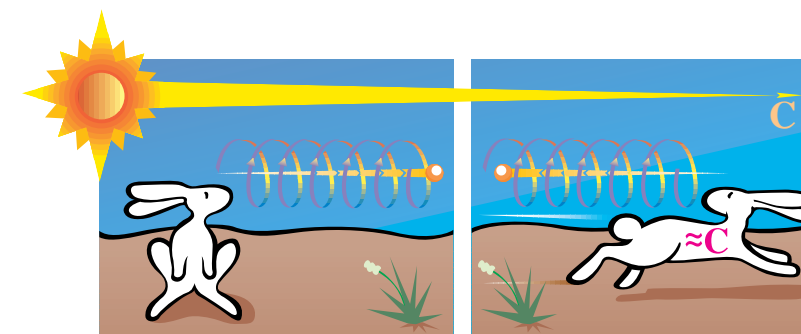

Looks like a left-handed corkscrew. No—like a right-handed corkscrew!

Figure 18. Helicity and Handedness

(a) The Standard Model. The four helicity and the four handedness (chirality) states of the electron are illustrated here. The strikers between these states indicate that each handedness state can be written as a linear combination of helicity states. The neutrino has only two states, and because it is massless, its helicity is identical to its handedness. Recall that the spin can be represented by a pseudovector (red arrow) and that its direction relative to the momentum determines helicity.

(b) Neutrinos with mass. The states of the Dirac neutrino versus those of the Majorana neutrino are shown. Like the electron, the Dirac neutrino has four helicity and four chirality states. The Majorana neutrino has only two handedness and two helicity states. Further, no clear distinction exists between particle and antiparticle.

(c) Effects of mass terms on particle states. Mass terms always flip the handedness of a particle. The Dirac mass term conserves lepton number or particle number, whereas a Majorana mass term changes particle into antiparticle as it changes the handedness. A Majorana mass term is allowed only for neutral particles. The mass term(s) of the neutrino could be Majorana, Dirac, or both combined.

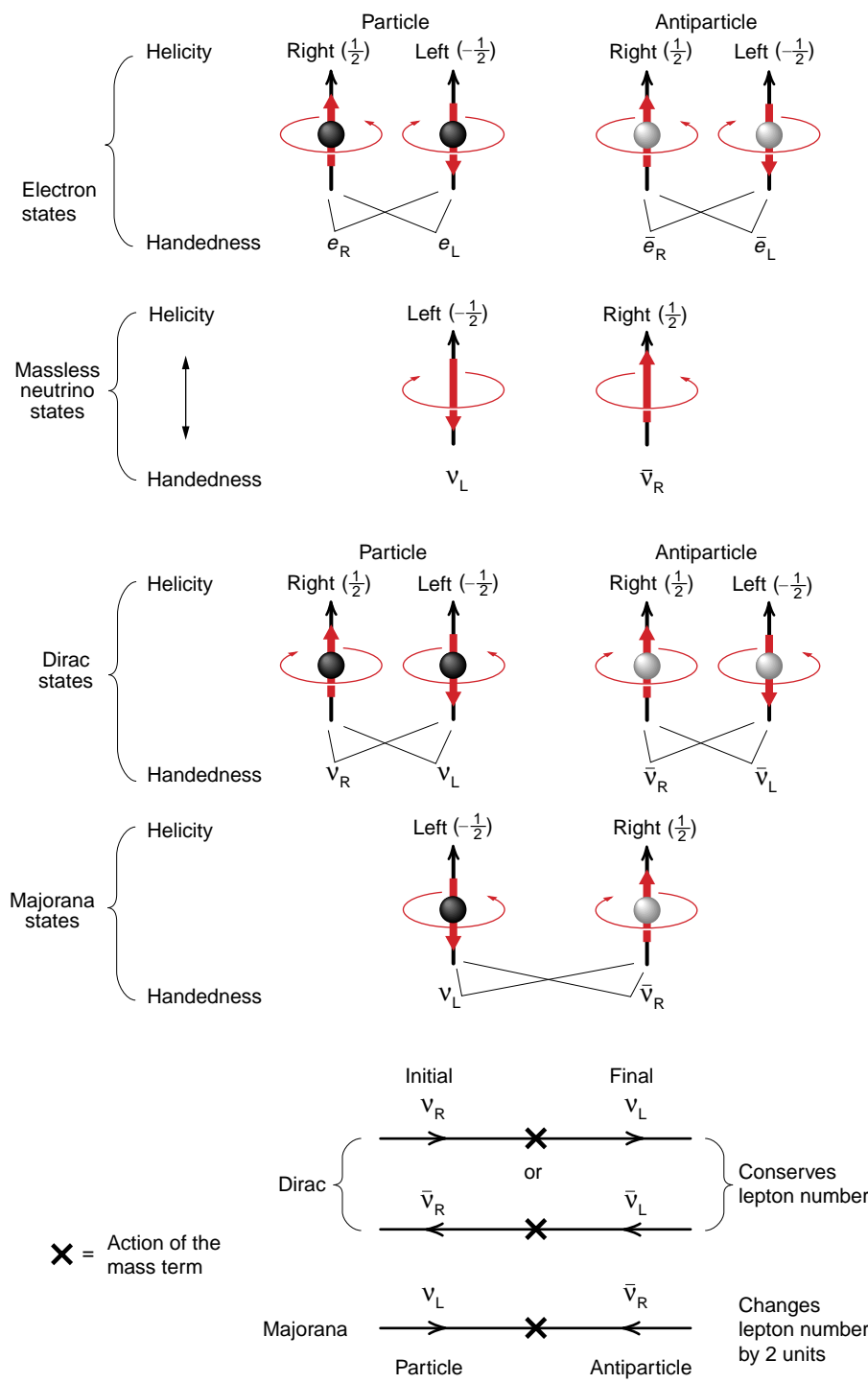

Table III. First-Family Weak States and Electroweak Charges in the Standard Model

Particle Number N	Handedness N_x	Particle States	Weak Isotopic Charge I_3^w	Weak Hypercharge Y^w	Electric Charge Q
QUARKS					
+1	L	$\begin{pmatrix} u_L \\ d_L \end{pmatrix}$	+1/2	+1/3	+2/3
+1	L		-1/2	+1/3	-1/3
-1	R	$\begin{pmatrix} \bar{u}_R \\ \bar{d}_R \end{pmatrix}$	-1/2	-1/3	-2/3
-1	R		+1/2	-1/3	+1/3
+1	R	u_R	0	+4/3	+2/3
-1	L	\bar{u}_L	0	-4/3	-2/3
+1	R	d_R	0	-2/3	-1/3
-1	L	\bar{d}_L	0	+2/3	+1/3
LEPTONS					
+1	L	$\begin{pmatrix} e_L \\ \nu_L \end{pmatrix}$	-1/2	-1	-1
+1	L		+1/2	-1	0
-1	R	$\begin{pmatrix} \bar{e}_R \\ \bar{\nu}_R \end{pmatrix}$	+1/2	+1	+1
-1	R		-1/2	+1	0
+1	R	e_R	0	-2	-1
-1	L	\bar{e}_L	0	+2	+1
+1	R	ν_R	0	0	0
-1	L	$\bar{\nu}_L$	0	0	0
HIGGS BOSONS					
0	0	$\begin{pmatrix} h^+ \\ h^0 \end{pmatrix}$	+1/2	+1	+1
0	0		-1/2	+1	0

$Q = I_3^w + \frac{Y^w}{2}$

R = Right-handed
L = Left-handed

Although the mathematical definition of handedness is beyond this discussion, we can get a more concrete idea by seeing the purely left-handed and purely right-handed states of, say, the electron written in terms of helicity states $|e_\lambda\rangle$:

$$\begin{aligned} |e_L\rangle &\propto |e_{-1/2}\rangle + m/E |e_{1/2}\rangle, \\ |e_R\rangle &\propto |e_{1/2}\rangle - m/E |e_{-1/2}\rangle, \end{aligned} \quad (13)$$

where m is the mass of the particle, E is its energy, and $\lambda = \mathbf{s} \cdot \mathbf{p}/|\mathbf{p}|$ is the helicity (with right- and left-handed projections of $1/2$ and $-1/2$, respectively). These formulas show that, if a particle is massless ($m = 0$), helicity and handedness are identical. And, if a left-handed particle is relativistic, or traveling at nearly the speed of light (m very much less than E), it is mostly in a state of left helicity; similarly, a right-handed particle traveling at relativistic speeds is mostly in a state of right helicity. Handedness and helicity are very much related, yet the two have quite different properties.

To see a tangible effect of those differences, consider the decay of the positively charged pion. This particle decays through the weak force into a lepton and an antilepton, either a positron and an electron neutrino ($\pi^+ \rightarrow e^+ + \nu_e$) or an antimuon and a muon neutrino ($\pi^+ \rightarrow \mu^+ + \nu_\mu$).

The decay into a positron yields more kinetic energy because the positron is lighter than the antimuon; so, if all else were equal, that decay would be more probable than the decay into a antimuon. Yet the opposite is true precisely because handedness and helicity are different. The pion has an intrinsic spin of zero, so for the decay of a pion at rest to conserve both angular and linear momentum, the spins and momenta of the two leptons must point in opposite directions (see Figure 19). In other words, the two leptons must be in the same helicity state. But the decay process occurs through the left-handed weak force and therefore produces a right-

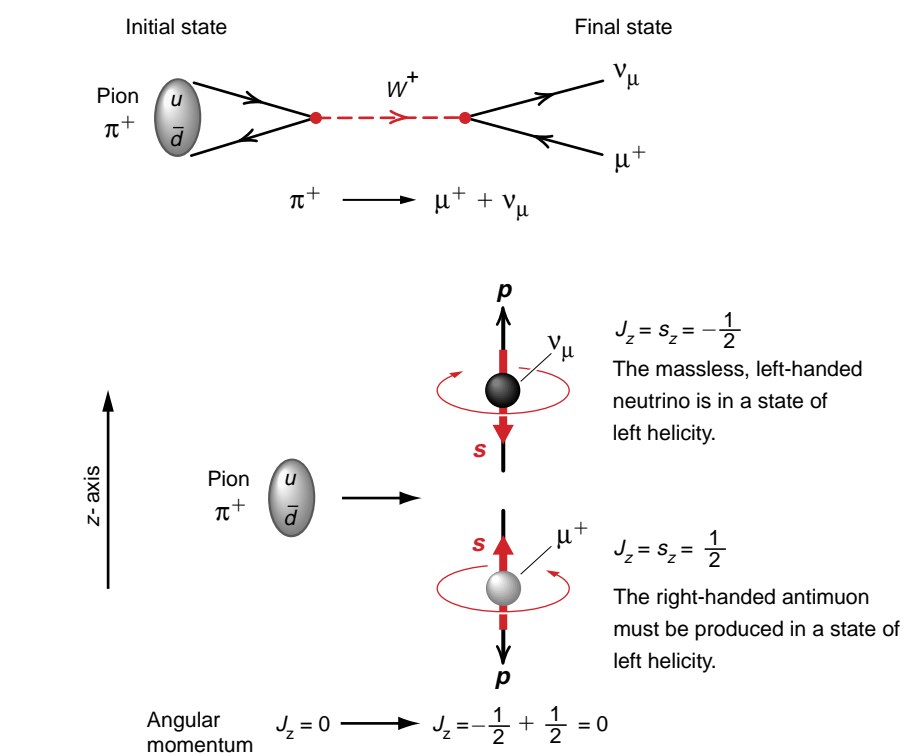

Figure 19. Pion Decay and Helicity versus Handedness

A π^+ has spin zero ($s = 0$). Through the weak force, it decays at rest into a μ^+ and a ν_μ . To conserve total momentum ($\mathbf{p} = 0$) and total angular momentum ($\mathbf{J} = 0$), these two particles must be emitted with equal and opposite momentum (black arrows), and their spins (red arrows) must point in opposite directions. The neutrino is emitted as a left-helicity particle because it is nearly massless. Thus, the μ^+ must also be in a state of left helicity. But the weak force produces only right-handed antiparticles. The decay shown here proceeds because a right-handed antimuon has a small component in the state of left helicity.

handed charged antilepton (antimuon or positron) and a left-handed lepton (muon neutrino or electron neutrino, respectively). The left-handed neutrino is massless, or nearly so, and from the formulas above, it must be in a state of left helicity. Therefore, only the fraction of the right-handed charged antilepton that is in the state of left helicity can take part in the decay. Being proportional to m/E , the left-helicity fraction is much larger for the antimuon than for the positron. Since the decay rate is proportional to the square of that fraction, the pion decays into an antimuon about 10^4 times more frequently than into a positron!

Dirac versus Majorana Neutrinos—Adding Neutrino Masses to the Standard Model. Knowing how handedness and helicity differ for particles with mass, we can return to the question of Majorana versus Dirac neutrinos. Were the neutrino truly massless, there would be no way to tell whether it is a Dirac or Majorana particle. Either way, there would be two neutrino states: ν_L and $\bar{\nu}_R$. Each would travel at the speed of light, and each would maintain its handedness (and its helicity) independent of the observer’s reference frame. Either way, the weak isospin doublets would be (ν_{eL}, e_L) and $(\bar{\nu}_{eR}, \bar{e}_R)$ as defined in Table III, and the members within each weak doublet would transform into

each other under the weak force.

The difference in the properties of a Dirac versus Majorana neutrino has to do with the way in which the neutrino acquires its mass. We already said that, whatever mechanism gives a spin-1/2 particle its mass, it must change that particle’s handedness by two units, from left to right or vice versa. Figure 20(a) illustrates how the electron, a Dirac particle with four states, acquires its mass in the Standard Model. The interaction is between the Higgs background (this is the Higgs mechanism that gives mass to all particles in the Standard Model) and the electron. Called a Dirac mass term, this interaction annihilates the state e_L and creates the state \bar{e}_R , or it annihilates \bar{e}_R and creates e_L . In each case, the mass term changes the handedness by two units, as required for any mass term. But it preserves the particle’s electric charge and lepton number because a particle state remains a particle state and an antiparticle state remains an antiparticle state.

Note that a mass term for the electron that changed e_L into \bar{e}_R is not an allowed mechanism for giving electrons their mass, even though it changes handedness by two units. It would change a negatively charged electron into a positively charged antielectron (positron), violating electric-charge conservation. But electric charge is known to be conserved. Such a term would also violate total-lepton-number conservation and electron-family-number conservation.

Now consider the neutrino. Since the neutrino has no electric charge, it has several possible mass terms. The diagrams in Figure 20(b) illustrate the interactions that might be added to the Standard Model to give mass to these neutral particles.⁸

The first is a Majorana mass term

⁸These extensions are explained more fully in the sidebar “Neutrino Masses—How to Add Them to the Standard Model” on page 64. They provide the simplest way of including nonzero neutrino masses while preserving the local gauge symmetries.

that again involves the Higgs background, but it acts between the two neutrino states already available in the Standard Model, changing ν_L into $\bar{\nu}_R$. The Majorana mass term changes both handedness and lepton number by two units. Since it changes a neutrino state into an antineutrino state, the distinction between particle and antiparticle becomes blurred. The neutrino becomes a Majorana particle, or its own antiparticle. This option requires no new neutrino states. The particular term shown in Figure 20(b.1) is called an “effective” theory, good only at low energies because, like Fermi’s original theory of beta decay, it gives physically inconsistent answers at high energies.

Figure 20(b.2) pictures the second approach: introducing a Dirac mass term for the neutrino analogous to that shown in Figure 20(a) for the electron. It would change ν_L into ν_R and $\bar{\nu}_R$ into $\bar{\nu}_L$. In other words, it would conserve lepton number. The Dirac mass term requires the introduction of the sterile states ν_R and $\bar{\nu}_L$, and the neutrino becomes a Dirac particle.

The Seesaw Mechanism for Making Neutrino Masses Very Small.

The problem with the second approach is that it does not explain why the neutrino masses are so small. In the Standard Model, particle masses are proportional to the strengths of the interactions between the particles and the Higgs bosons (see the box “Family Mixing and the Origin of Mass” on page 72). Thus, the Dirac mass term for, say, the electron neutrino must be multiplied by some very small coupling strength such that the mass of the electron neutrino is at least 50,000 times smaller than the mass of the electron. But the electron and the electron neutrino are part of the same weak doublet, and there seems to be no reason why they should have such enormously different interaction strengths to the Higgs bosons.

In 1979, without introducing an arbitrarily small coupling strength to the

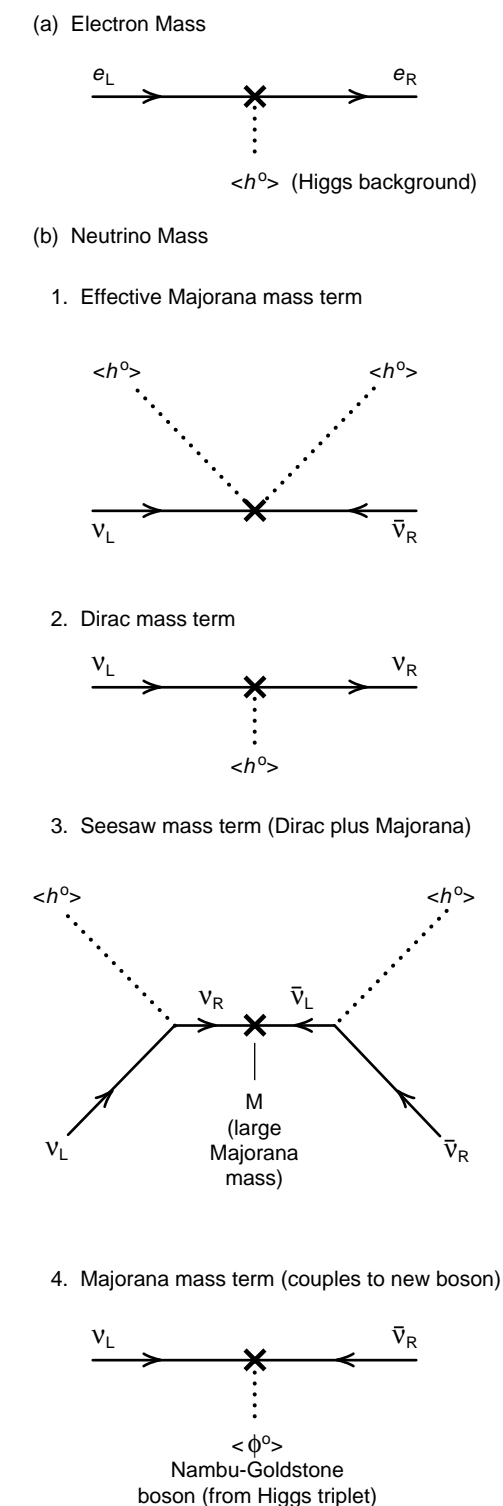

Figure 20. Neutrino Mass Terms The figures above illustrate the mechanisms for giving the neutrino its mass. In each case, the X represents the effect from the Higgs background. The direction of time is from left to right.

Higgs bosons, Murray Gell-Mann, Pierre Ramond, and Richard Slansky invented a model that yields very small neutrino masses. As explained in “Neutrino Masses,” the two neutrino states ν_R and $\bar{\nu}_L$ that must be added to the theory to form the Dirac mass term could themselves be coupled to form a Majorana mass term. That term could also be added to the theory without violating any symmetry principle.

Further, it could be assumed that the coefficient M of the Majorana mass term is very large. If the theory contains both Dirac mass term and this Majorana mass term, then the four components of the neutrino would no longer be states of definite mass m determined by the coefficient of the Dirac mass term. Instead, the four components would split into two Majorana neutrinos, each made up of two components. One neutrino would have a very small mass, equal to m^2/M from the mass term in Figure 20(b.3); the second neutrino would have a very large mass, approximately equal to M . The very light Majorana neutrino would mostly be the left-handed neutrino that couples to the W , and the very heavy neutrino would mostly be a right-handed neutrino that does not couple to the W . Similarly, the very light antineutrino would be mostly the original right-handed antineutrino that couples to the W , and the very heavy antineutrino would be mostly a left-handed antineutrino that does not couple to the W .

This so-called seesaw mechanism in which the Dirac mass m is reduced by a factor of m/M through the introduction of a large Majorana mass term has been used in many extensions to the Standard Model to explain why neutrino masses are small. The large Majorana mass M is often associated with some new, weak gauge force that operates at a very high energy (mass) scale dictated by the mass of a new, very heavy gauge boson. The net result of this approach is that the neutrino seen at low energies is predicted to be mostly a Majorana particle!

Figure 20(b.4) shows one last possibility for adding neutrino masses to the Standard Model. No new neutrino components are added to the Standard Model. Instead, the neutrino is postulated to be a two-component Majorana particle that acquires mass by coupling to a new type of Higgs boson, one that has three charge states and is a triplet in a weak isospin space. Thus, introducing a new type of Higgs boson allows neutrino masses to be added. This last possibility has several interesting consequences. Total-lepton-number conservation is not explicitly violated by the addition of a Majorana mass term. Instead, the new Higgs boson is assumed to have a nonzero vacuum value; the resulting Higgs background spontaneously breaks lepton-number conservation and gives a Majorana mass to the neutrino. A consequence of this spontaneous (or vacuum) breaking of the lepton-number symmetry is the existence of a massless scalar particle known as a Nambu-Goldstone boson. This massless boson could be produced in a new form of neutrinoless double beta decay.

Neutrinoless Double Beta Decay. The one process that should be within the limits of detectability and would exhibit the unmistakable mark of a Majorana neutrino is neutrinoless double beta decay. In double beta decay, two neutrons in a nucleus transform into two protons almost simultaneously and bring the nucleus to a stable configuration with an increase in electric charge of +2. This process occurs in “even-even” nuclei, those containing even numbers of protons and neutrons. Like single beta decay, double beta decay occurs through the interaction of a nucleus with the W . In the “ordinary” process shown in Figure 21(a), the nucleus emits two electrons and two antineutrinos. Figure 21(b) shows, however, that if the neutrino is a Majorana particle, the same process can occur without the emission of any neutrinos—hence the name of neutrinoless double beta decay. The weak force has not changed its character. Indeed, when

the first neutron transforms into a proton and emits a W , that W produces a right-handed antineutrino and an electron, as usual. Then that *right-handed antineutrino* switches to a *left-handed neutrino* through the interaction that gives the neutrino its Majorana mass. Finally, this left-handed neutrino then interacts with the second W (emitted when the second neutron transforms into a proton), and the left-handed electron neutrino is transformed into a left-handed electron. The neutrino is never seen; it is a virtual particle exchanged between the two W s that are emitted when the two neutrons change into two protons simultaneously. The net result is that two neutrons in a nucleus turn into two protons and two electrons are emitted. In this process, the total charge is conserved, but the number of leptons has changed from zero to two. Also, because no neutrinos are emitted, the two electrons will always share all the available energy released in the decay, and thus the sum of their energies has a single value, the single spike in Figure 21(a), rather than a spectrum of values as in ordinary double beta decay.

The rate of neutrinoless double beta decay is proportional to an effective mass that is a complicated sum over the three neutrino masses. This sum involves the intrinsic charge-conjugation and parity properties of the neutrinos (CP parities), and the resulting phases multiplying each mass can lead to cancellations such that the effective mass is smaller than any of the individual masses of the neutrinos. At present, the experimental upper limit on the effective mass is about 2 eV.

Finally, if the neutrino acquires mass through the vacuum value of a Higgs triplet, as discussed above, a massless Nambu-Goldstone boson would be emitted along with the two electrons of the neutrinoless double beta decay. The presence of the massless boson would lead to a definite energy spectrum for the emitted electrons that would distinguish this form of double beta decay from either ordinary double beta decay or neutrinoless double beta decay.

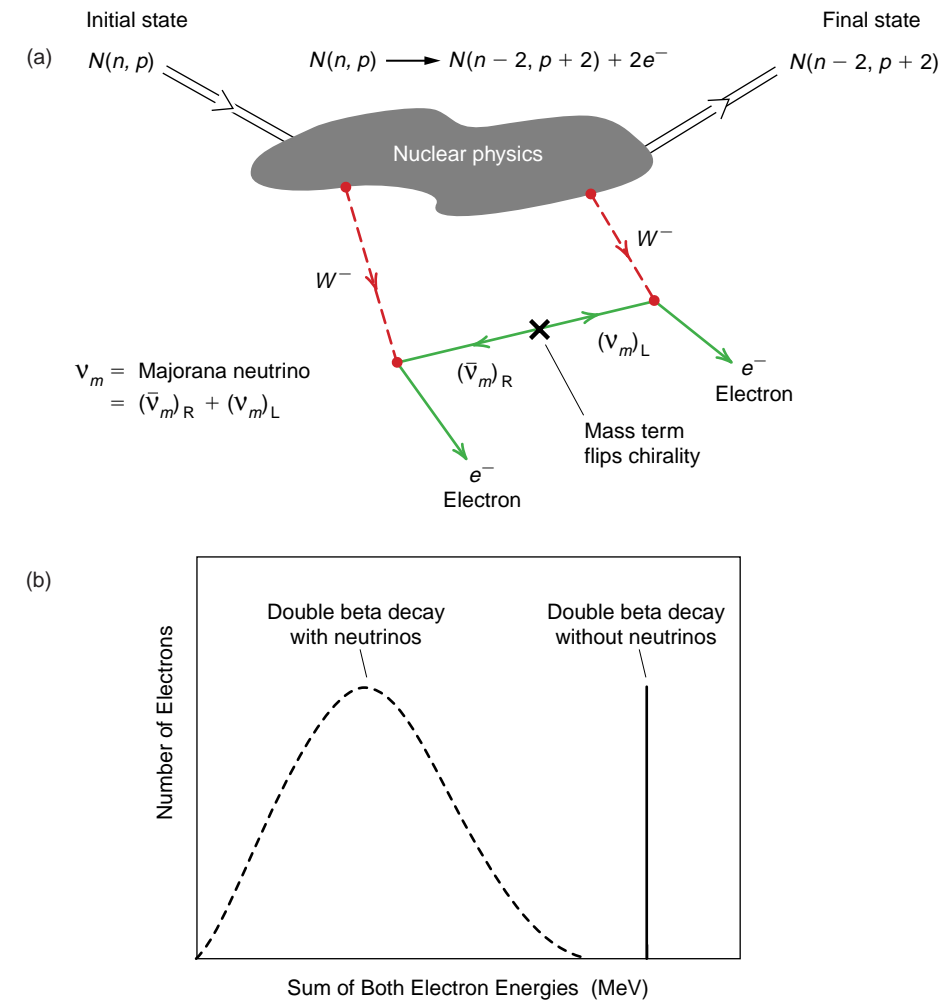

Figure 21. Neutrinoless Double Beta Decay
 (a) The exchange of a virtual Majorana neutrino allows double beta decay to occur without the emission of any neutrinos. A right-handed Majorana antineutrino is emitted (along with an electron) from the weak vertex at left. Its handedness flips as it propagates through the interaction with the Higgs background, and the right-handed antineutrino becomes a left-handed Majorana neutrino. In its left-handed form, this particle has the correct handedness to be absorbed at the weak vertex at right and then transformed into an electron. Thus, two electrons are emitted as the nucleus increases its positive electric charge by two units. (b) The spectrum of the total energy carried by two electrons from neutrinoless double beta decay is just a single line because the two electrons always carry off all the available energy (a heavy nucleus absorbs momentum but, essentially, no energy). In contrast, the electrons from ordinary double beta decay share the available energy with the two electron antineutrinos emitted in the decay.

Implications of Neutrino Mass for Astrophysics, Cosmology, and Particle Physics

If neutrino masses and oscillations are real, they can have an impact on astrophysics and cosmology, and, conversely, astrophysics and cosmology will place constraints on the masses of neutrinos and on the number or types of neutrinos. Neutrinos are very weakly coupled to matter. At energies of 1 MeV, a neutrino interacts 10^{20} times less often than a photon. To have any impact at all, they must be present in extraordinary numbers. One such “place” is the universe itself. Neutrinos left over from the Big Bang fill the universe and outnumber protons and neutrons by a billion to one. On average, the universe contains about 300 neutrinos per cubic centimeter, 100 of each of

the three types. If individual neutrino masses are on the order of a few electron volts, their sum would add up to a significant fraction of the mass of the universe—not enough mass to close the universe and have it collapse back on itself (that would require the average mass of the three neutrinos to be 30 eV), but at smaller values, it could have influenced the expansion of matter after the Big Bang and helped produce the superlarge-scale filigree pattern of galaxies and galactic clusters that extends as far as today’s telescopes can see. (See the article “Dark Matter and Massive Neutrinos” on page 180.)

Neutrino oscillations, too, may be an important ingredient in making the universe as we know it. For example, the neutrinos we know might oscillate into sterile neutrinos, those which have no weak interactions at all. The presence

of these sterile neutrinos in the cosmic soup could shift the delicate balance of ingredients needed to predict the observed primordial abundances of helium and other light elements up through lithium. As a result, nucleosynthesis calculations place stringent limits on sterile neutrinos, ruling out significant portions in the $\Delta m^2 - \sin^2\theta$ plane for the mixing between ordinary and sterile neutrinos.

Oscillation could also alter the picture of the neutrino as the driver of supernova explosions (see the article “Neutrinos and Supernovae” on page 164). Electron neutrinos, the primary drivers, might be lost or gained from the region that powers the explosion, depending on the oscillation length and, again, on whether sterile neutrinos exist. Neutrino oscillations and the enhancement of those oscillations through interactions with matter

may also be the only way to create the neutron-rich environment that is absolutely required for the synthesis of the elements heavier than iron. And to recap the earlier discussion, oscillation of one neutrino type into another might explain why neutrino physicists have been measuring a shortfall in the ratio of muon neutrinos to electron neutrinos produced by cosmic rays in the upper atmosphere. Matter-enhanced neutrino oscillations in the electron-rich environment of the Sun might explain why physicists observe a shortfall in the flux of electron neutrinos that are produced by thermonuclear fusion processes in the core of the Sun.

Grand Unified Theories. On a more abstract note, the existence of neutrino masses and mixing will extend the close parallel already observed between quarks and leptons and, for that reason, may well add fuel to the ongoing search for a theory that unifies the strong, weak, and electromagnetic forces. Attempts to explain the pattern of charges and masses of quarks and leptons within a single weak family column in Figure 5 lead naturally to an extension of the Standard Model known as the Grand Unified Theories. In these theories, the local gauge symmetries of the weak, strong, and electromagnetic forces are subsumed under a larger local gauge symmetry. That larger symmetry becomes apparent only at the enormous energies and tiny distance scales known as the unification scale. At that scale, the strong, weak, and electromagnetic forces become unified into one force, and the quarks and leptons within a family become members of a particle multiplet that transform into each other under the unified force, just as the members of each weak isospin doublet transform into each other under interaction with the W .

The Grand Unified Theories provide a natural explanation for the different charges (electric, weak, and strong) for particles in a family. In addition, these theories make several successful predictions. Since the strong, weak, and

electromagnetic forces become one at the unification scale, these theories constrain the strengths of the strong, weak, and electromagnetic couplings to be equal at that scale. Thus, one can put the measured values of the weak- and electromagnetic-coupling strengths into the framework of the Grand Unified Theories and predict the strong-coupling strength and the scale of unification.

In the Grand Unified Theories that include a new symmetry, called supersymmetry, the prediction for the strong coupling agrees with all the available data, and the grand unification scale turns out to be on order of 10^{16} GeV. (For comparison, the proton mass $\approx 1 \text{ GeV}/c^2$, and the largest accessible energies at the new accelerator being planned in Europe will be a few times 10^3 GeV.) These supersymmetric theories also predict relations between the masses of the charged quarks and leptons, and these relations are also well satisfied. Neutrino masses are typically not as constrained as charged fermion masses because the neutrino sector contains the possibility of very heavy (as in the seesaw) Majorana masses.

The proton, which is the most stable particle we know, is typically unstable in the Grand Unified Theories and has a lifetime set by the grand unification scale. Supersymmetric Grand Unified Theories predict that the dominant decay mode for the proton is $p \rightarrow K^+ + \bar{\nu}$. The cumulative evidence collected over the next five years at super-Kamiokande will be sensitive to this decay mode with a predicted lifetime on the order of 10^{33} years. Finally, supersymmetric Grand Unified Theories require new particle states, some of which may be observed at high-energy accelerators, specifically, at the new Large Hadron Collider at CERN scheduled for completion in 2002, at the Fermilab Tevatron (an 1,800-GeV machine) following its upgrade in 1999, and at the Hadron Electron Ring Accelerator at DESY (Deutsches Elektronen Synchrotron). These new states can lead to observable lepton family mixing such as

$\mu^- \rightarrow e^- + \gamma$, and they typically provide a candidate for the cold dark matter that may be needed to explain the observed large-scale structures and large-scale motions of the luminous matter.

Superstrings and Conclusions

To tie up our discussion, we will mention superstring theory, one possible truly unified theory that includes not only the electroweak and strong interactions, but also gravity in the sense of a quantum mechanical theory of Einstein's general theory of relativity. Although not yet a full-fledged theory, superstrings have enjoyed significant recent progress. At "low energies" (although they are very high compared with current accelerator energies), superstring theories reduce to models with large gauge symmetries that may unify the electroweak and strong interactions, along with other undiscovered interactions of nature. Although superstrings are insufficiently formulated to predict the parameters of the Grand Unified Theories, the suggestive link between the two makes us pay close attention to the Grand Unified Theories, even in the absence of direct experimental evidence for them. On a less ambitious plane, experimental values for neutrino masses and mixing angles would constrain the parameters of the Grand Unified Theories—particularly when there is a better understanding of the origin of mass and mixing.

No one yet understands why mass states and weak states differ or, even with experimental data on hand, why the pattern of mixing for quarks is as we observe it. Why there should be three repetitive families is likewise mysterious. If we are to develop a unified theory combining the quark and lepton families, we need to solve these unknowns. Neutrino masses and mixings are among the few uncharted realms that may provide important clues to this puzzle. ■

Further Reading

- Bernstein, J. 1969. *The Elusive Neutrino*. United States Atomic Energy Commission—Division of Technical Information. Library of Congress Catalog Card Number: 71-601702.
- Cardall, C. Y., and G. M. Fuller. 1996. Can a "Natural" Three-Generation Neutrino Mixing Scheme Satisfy Everything? *Physical Review D* **53**: 4421.
- Fermi, E. 1933. Tentative Theory of Beta-Radiation. In Strachan, C. 1969. *The Theory of Beta-Decay*. New York: Pergamon Press.
- Feynman, R. P., and M. Gell-Mann. 1958. Theory of the Fermi Interaction. *Physical Review* **109** (1): 193.
- Halzen, F., and A. D. Martin. 1984. *Quarks & Leptons: An Introductory Course in Modern Particle Physics*. New York: John Wiley & Sons, Inc.
- Kayser, B., F. Gibrat-Debu, and F. Perrier. 1989. *The Physics of Massive Neutrinos*. World Scientific Lecture Notes in Physics Vol. 25. Singapore: World Scientific.
- Lee, T. D., and C. N. Yang. 1957. Parity Nonconservation and a Two-Component Theory of the Neutrino. *Physical Review* **105** (5): 1671.
- Particle Physics*. 1984. Los Alamos Science. Summer/Fall. Number 11. Los Alamos National Laboratory document LA-UR-84-2100.
- Riordan, M. 1987. *The Hunting of the Quark: A True Story of Modern Physics*. New York: Simon and Schuster/Touchstone.
- Strachan, C. 1969. *The Theory of Beta-Decay*. New York: Pergamon Press.
- Sutton, C. 1992. *Spaceship Neutrino*. New York: Cambridge University Press.
- Weinberg, S. 1995. *The Quantum Theory of Fields*. Volume II. New York: Cambridge University Press.

Acknowledgment

N. Cooper would like to thank Peter Herczeg for many illuminating conversations and for inspiring greater clarity and precision in understanding the neutrino.

Richard (Dick) Slansky was born in California. Having earned a B.A. from Harvard and a Ph.D. in physics from the University of California at Berkeley (in 1967), Slansky became postdoctoral fellow at Caltech and later assistant professor in the Physics Department at Yale University. In 1974, he joined Los Alamos as a staff member in the newly established Elementary Particles and Field Theory Group in the Theoretical (T) Division. At the Laboratory, his interests turned to unified theories of electroweak and strong interactions—proton decay, neutrino masses, and applying group theory to these unified theories. Slansky was also active in string theory, and he co-authored a two-volume book on the highest weight representations of Kac-Moody algebras. Eventually, he worked on numerous interdisciplinary issues and was appointed adjunct professor of physics at the University of California at Irvine. Slansky then became a Laboratory Fellow and a Fellow of the American Physical Society and the American Association for the Advancement of Science. In 1993, after having been T-Division leader at Los Alamos for four years, Slansky was reappointed as T-Division Director, a position he currently holds.

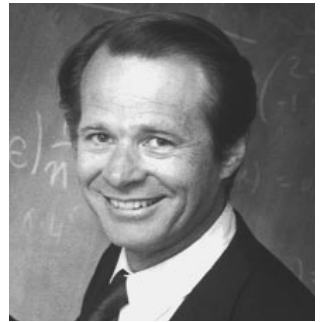

Stuart Raby was born in Bronx, New York, and has been a physics professor at the Ohio State University in Columbus, Ohio, since 1989. He is married to Elaine M. Raby and is a proud parent of Eric and Liat. Raby received his B.Sc. from the University of Rochester in 1969 and an M.Sc. and a Ph.D. from Tel Aviv University in 1973 and 1976, respectively. He was a postdoctoral fellow at Cornell and Stanford Universities as well as a visiting professor at the University of Michigan before joining the Laboratory as a staff member in the Elementary Particles and Field Theory Group, whose leader he became in 1985. His research interests include physics beyond the Standard Model, the origin of fermion masses, flavor violation, and consequences for laboratory experiments, cosmology, and astrophysics. Raby is a leading advocate for supersymmetric Grand Unified Theories of nature.

These theories provide the simplest explanation for the experimentally measured unification of the strong, weak, and electromagnetic charges and for the observed spectrum of fermion masses and mixing angles. They also make testable predictions for flavor violation and nucleon decay processes.

T. (Terry) Goldman received a B.Sc. (Hons.) in physics and mathematics in 1968 from the University of Manitoba and an A.M. and a Ph.D. in physics from Harvard in 1969 and 1973, respectively. Goldman was a Woodrow Wilson Fellow from 1968 to 1969 and a National Research Council of Canada postdoctoral fellow at the Stanford Linear Accelerator from 1973 until 1975, when he joined the Laboratory's Theoretical Division as a postdoctoral fellow. In 1978, Goldman became a staff member in the Medium Energy Theory Group at Los Alamos. From 1978 to 1980 he was on leave from the Laboratory as a senior research fellow at the California Institute of Technology, and during the academic year 1982–1983, he was a visiting associate professor at the University of California, Santa Cruz. In 1991, Goldman became group leader in T-5. His research interests are in the areas of electroweak interactions and the quark structure of nuclei. Goldman is a member of the American Physical Society.



Gerry Garvey was born in New York City. He earned a B.S. in physics from Fairfield University and, in 1962, a Ph.D. in physics from Yale University. He then served as a faculty member at Yale and Princeton Universities, becoming a full professor in 1969. After being an Alfred Sloan Foundation Fellow from 1967 to 1969, he spent a year at the Clarendon Laboratory in Great Britain. In 1976, he became Director of the Physics Division at Argonne National Laboratory and in 1979 was named Associate Laboratory Director for Physical Science. From 1979 through 1984, Garvey was a professor at the University of Chicago, returning in 1980 to full-time research as a senior scientist at Argonne. In 1984, he joined Los Alamos as director of LAMPF. In 1990, Garvey stepped down from that position to become a Laboratory Senior Fellow, a position he currently holds. From 1994 through 1996, he served as the Assistant Director for Physical Science and Engineering in the White House Office of Science and Technology. Garvey is an active member of the American Physical Society, having been chairman and councilor for the Division of Nuclear Physics.

Neutrino Masses

How to add them to the Standard Model

Stuart Raby and Richard Slansky

The Standard Model includes a set of particles—the quarks and leptons—and their interactions. The quarks and leptons are spin-1/2 particles, or fermions. They fall into three families that differ only in the masses of the member particles. The origin of those masses is one of the greatest unsolved mysteries of particle physics. The greatest success of the Standard Model is the description of the forces of nature in terms of local symmetries. The three families of quarks and leptons transform identically under these local symmetries, and thus they have identical strong, weak, and electromagnetic interactions.

In the Standard Model, quarks and leptons are assumed to obtain their masses in the same way that the W and Z^0 bosons obtain theirs: through interactions with the mysterious Higgs boson (named the “God Particle” by Leon Lederman). But before we write down some simple formulas that describe the interactions of quarks and leptons with the Higgs boson, let us define some notation.

Defining the Lepton Fields. For every elementary particle, we associate a field residing in space and time. Ripples in these fields describe the motions of these particles. A quantum mechanical description of the fields, which allows one to describe multiparticle systems, makes each field a quantum mechanical operator that can create particles out of the ground state—called the *vacuum*. The act of creating one or more particles in the vacuum is equivalent to describing a system in which one or more ripples in the fabric of the field move through space-time.

Let us now discuss the simple system of one family of leptons. To be specific, we will call the particles in this family the electron and the electron neutrino. The electron field describes four types of ripples (or particles). We label these four types by two quantum charges called fermion number N and handedness, or chirality, N_x . For the electron field, the particle state with fermion number $N = +1$ is the electron, and the particle state with $N = -1$ is the antielectron (or positron). Each of these states comes as right-handed, $N_x = R$, and left-handed, $N_x = L$. Handedness is a Lorentz invariant quantity that is related in a nontrivial way to helicity, the projection of the spin s in the direction of the momentum \mathbf{p} . (For a discussion of handedness versus helicity, see “The Oscillating Neutrino” on page 28.)

In relativistic quantum field theory, the right-handed and left-handed electron and the right-handed and left-handed antielectron can be defined in terms of two fields denoted by e and e^c , where each field is a Weyl two-component left-handed spinor. The compositions of the fields are such that

e annihilates a left-handed electron e_L or creates a right-handed positron \bar{e}_R , and

e^c annihilates a left-handed positron \bar{e}_L or creates a right-handed electron e_R .

These fields are complex, and for the action of the Hermitian conjugate fields e^\dagger and $e^{c\dagger}$, just interchange the words annihilate and create above. For example, e^\dagger creates a left-handed electron or annihilates a right-handed positron. Hence, the fields e and e^c and their complex conjugates can create or annihilate all the possible excitations of the physical electron. Note that parity (defined as the inversion

of spatial coordinates) has the property of interchanging the two states e_R and e_L .

What about the neutrino? The right-handed neutrino has never been observed, and it is not known whether that particle state and the left-handed antineutrino exist. In the Standard Model, the field ν_e^c , which would create those states, is not included. Instead, the neutrino is associated with only two types of ripples (particle states) and is defined by a single field ν_e :

ν_e annihilates a left-handed electron neutrino ν_{eL} or creates a right-handed electron antineutrino $\bar{\nu}_{eR}$.

The left-handed electron neutrino has fermion number $N = +1$, and the right-handed electron antineutrino has fermion number $N = -1$. This description of the neutrino is not invariant under the parity operation. Parity interchanges left-handed and right-handed particles, but we just said that, in the Standard Model, the right-handed neutrino does not exist. The left-handedness of the neutrino mimics the left-handedness of the charged-current weak interactions. In other words, the W

gauge boson, which mediates all weak charge-changing processes, acts only on the fields e and ν_e . The interaction with the W transforms the left-handed neutrino into the left-handed electron and vice versa ($e_L \leftrightarrow \nu_{eL}$) or the right-handed antineutrino into the right-handed positron and vice versa ($\bar{\nu}_{eR} \leftrightarrow \bar{e}_R$). Thus, we say that the fields e and ν_e , or the particles e_L and ν_{eL} , are a weak isospin doublet under the weak interactions.

These lepton fields carry two types of weak charge: The weak isotopic charge I_3^w couples them to the W and the Z^0 , and the weak hypercharge Y^w couples them to the Z^0 . (The Z^0 is the neutral gauge boson that mediates neutral-current weak interactions.) Electric charge Q is related to the two weak charges through the equation $Q = I_3^w + Y^w/2$. Table I lists the weak charges for the particle states defined by the

three fields e , ν_e , and e^c . Note that the particle states e_R and \bar{e}_L defined by the field e^c do not couple to the W and have no weak isotopic charge. The field and the particle states are thus called weak isotopic singlets. However, e_R and \bar{e}_L do carry weak hypercharge and electric charge and therefore couple to the Z^0 and the photon.

Likewise, the field ν_e^c and its neutrino states ν_{eR} and $\bar{\nu}_{eL}$ would be isotopic singlets with no coupling to the W . But unlike their electron counterparts, they must be electrically neutral ($Q = I_3^w + Y^w/2 = 0$), which implies they cannot have weak hypercharge. Thus, they would not couple to the W , the Z^0 , or the photon. Having no interactions and, therefore, not being measurable, they are called *sterile* neutrinos and are not included in the Standard Model. However, if the left-handed neutrino has mass, it may oscillate into a sterile right-handed neutrino, a possibility that could be invoked in trying to give consistency to all the data on neutrino oscillations.

The Origin of Electron Mass in the Standard Model. What is mass? Mass is the inertial energy of a particle. It is the energy a particle has when at rest and the measure of the resistance to an applied force according to Newton’s law $F = ma$. A massless particle cannot exist at rest; it must always move at the speed of light.

Table I. Lepton Charges

$Q = I_3^w + \frac{Y^w}{2}$					
N	N_x	Particle States	I_3^w	Y^w	Q
+1	L	$\begin{pmatrix} e_L \\ \nu_L \end{pmatrix}$	-1/2	-1	-1
+1	L		+1/2	-1	0
-1	R	$\begin{pmatrix} \bar{e}_R \\ \bar{\nu}_R \end{pmatrix}$	+1/2	+1	+1
-1	R		-1/2	+1	0
+1	R	e_R	0	-2	-1
-1	L	\bar{e}_L	0	+2	+1
+1	R	ν_R	0	0	0
-1	L	$\bar{\nu}_L$	0	0	0

A fermion (spin-1/2 particle) with mass has an additional constraint. It must exist in both right-handed and left-handed states because the only field operators that yield a nonzero mass for fermions are bilinear products of fields that flip the particle's handedness. For example, in the two-component notation introduced above, the standard, or Dirac, mass term in the Lagrangian for free electrons is given by*

$$m_e e^c e . \quad (1)$$

This fermion mass operator annihilates a left-handed electron and creates a right-handed electron in its place. The mass term does not change the charge of the particle, so we say that it conserves electric charge. Also, because this mass term does not change a particle into an antiparticle, we say that it conserves fermion number N . However, the weak isospin symmetry forbids such a mass operator because it is not an invariant under that symmetry. (The field e is a member of a weak isotopic doublet, whereas the field e^c is a weak isotopic singlet, so that the product of the two is not a singlet as it should be to preserve the weak isospin symmetry.) But the electron does have mass. We seem to be in a bind.

The Standard Model solves this problem: the electron and electron neutrino fields are postulated to interact with the spin-zero Higgs field h^0 (the God particle). The field h^0 is one member of a weak isospin doublet whose second member is h^+ . The superscripts denote the electric charge of the state annihilated by each field (see Table III on page 57 for the other quantum number of the two fields). The field h^0 plays a special role in the Standard Model. Its ground state is not a vacuum state empty of particles, but it has a nonzero mean value, much like a Bose-Einstein condensate. This nonzero value, written as the vacuum expectation value $\langle 0|h^0|0\rangle \equiv \langle h^0\rangle = v/\sqrt{2}$ is the putative "origin of mass." (The "mystery" of mass then becomes the origin of the Higgs boson and its nonzero vacuum value.)

The interaction between the Higgs fields and the electron and electron neutrino is given by

$$\lambda_e e^c (\nu_e (h^+)^{\dagger} + e (h^0)^{\dagger}) , \quad (2)$$

where λ_e is called a Yukawa coupling constant and describes the strength of the coupling between the Higgs field and the electron. The Higgs field is a weak isospin doublet, so the term in parentheses is an inner product of two doublets, making an invariant quantity under the weak isospin symmetry. Since it also conserves weak hypercharge, it preserves the symmetries of the Standard Model.

Because the mean value of h^0 in the vacuum is $\langle h^0\rangle = v/\sqrt{2}$, the operator in (2) contributes a term to the Standard Model of the form

$$\lambda_e \langle h^0\rangle e^c e = (\lambda_e v/\sqrt{2}) e^c e . \quad (3)$$

In other words, as the electron moves through the vacuum, it constantly feels the interaction with the Higgs field in the vacuum. But (3) is a fermion mass operator exactly analogous to the Dirac mass operator in (1), except that here the electron rest mass is given by

$$m_e = \lambda_e v/\sqrt{2} . \quad (4)$$

We see that, in the Standard Model, electron mass comes from the Yukawa interaction of the electron with the Higgs background.

Why Neutrinos Are Massless in the Minimal Standard Model. What about the neutrino? Because the neutrino has spin 1/2, its mass operator must also change handedness if it is to yield a nonzero value. We could introduce a Dirac mass term

for the neutrino that would mirror the mass term for the electron. It would have the form

$$m_\nu \nu_e^c \nu_e . \quad (5)$$

But, as we said above, the field ν_e^c is not included in the Standard Model because, so far, weak-interaction experiments have not required it. The neutrino, though, has no electric charge, which makes it possible to write down a mass term from the existing neutrino field ν_e with the form

$$\frac{1}{2} \mu_\nu \nu_e \nu_e . \quad (6)$$

(Note that m_ν and μ_ν refer just to the electron neutrinos, but similar masses can be defined for the μ and τ neutrinos.) The mass operator in (6) annihilates a left-handed neutrino and creates a right-handed antineutrino, which means that it is a Majorana mass term. *Any mass term that changes a particle to an antiparticle is called a Majorana mass term.* In changing a neutrino to an antineutrino, this term violates fermion number N , changing it by two units. It is a legitimate mass term in that it changes handedness in the right way to yield a nonzero rest mass, and it conserves electric charge because the neutrino is electrically neutral. Nevertheless, it is not included in the Standard Model because it violates the weak symmetry in two ways: It is not invariant under the weak isospin symmetry, and it changes the weak hypercharge by two units. We conclude that, in the minimal Standard Model, which does not include ν_e^c and contains only the Higgs doublet mentioned above, there is no way to give mass to the neutrinos if fermion number is conserved.

Two consequences follow directly from the result that neutrino masses are identically zero in the minimal Standard Model. First, the weak eigenstates and the mass eigenstates of the leptons are equivalent, and therefore individual-lepton-family number (electron number, muon number, and tau number) are conserved (for the proof, see "Family Mixing and the Origin of Mass" on page 72). Thus, the Standard Model forbids such processes as

$$\mu^+ \rightarrow e^+ + \gamma , \text{ or} \quad (7)$$

$$\mu^+ \rightarrow e^+ + e^+ + e^- . \quad (8)$$

Similarly, the proposed process of neutrino oscillation, which may recently have been observed, is forbidden. Second, total lepton number, equal to the sum of individual-family-lepton numbers, is also conserved, and the process of neutrinoless double beta decay is forbidden.

The converse is also true: If individual-lepton-number violation is observed, or if the LSND results on neutrino oscillation are confirmed, then either of those experiments could claim the discovery of nonzero neutrino masses and thus of *new physics beyond the Standard Model*.

Adding Neutrino Masses to the Standard Model. What could this new physics be? There are several simple extensions to the Standard Model that could yield nonzero neutrino masses without changing the local symmetry of the weak interactions.

The simplest extension would be to add no new fields but just a new "effective" interaction with the Higgs field:

$$\frac{1}{M_{\text{effective}}} (h^0 \nu_e - h^+ e)^2 . \quad (9)$$

*The addition of the Hermitian conjugate is assumed in 1 equations if the operator is not explicitly Hermitian.

This effective interaction is invariant under the local symmetries and yields a Majorana mass term equal to

$$\frac{1}{M_{\text{effective}}} \langle h^0 \rangle^2 \nu_e \nu_e \quad , \quad (10)$$

and a value for the neutrino mass

$$\mu_\nu = \frac{2 \langle h^0 \rangle^2}{M_{\text{effective}}} = \frac{v^2}{M_{\text{effective}}} \quad . \quad (11)$$

This mass term, as all fermion mass terms, changes handedness from left to right, but it violates the fermion number N listed in Table I. The term $M_{\text{effective}}$ must be large so that the mass of the neutrino be small. The new term in (9) is called “effective” because it can only be used to compute the physics at energies well below $M_{\text{effective}}c^2$, just as Fermi’s “effective” theory of beta decay yields valid approximations to weak processes only at energies well below M_Wc^2 , where M_W is the mass of the W . (Outside their specified energy ranges, “effective” theories are, in technical language, nonrenormalizable and yield infinite values for finite quantities.) Thus, the mass term in (9) implicitly introduces a new scale of physics, in which new particles with masses on the order of $M_{\text{effective}}$ presumably play a role. Below that energy scale, (9) describes the effects of the seesaw mechanism for generating small neutrino masses (see below as well as the box “The Seesaw Mechanism at Low Energies” on page 71).

A Dirac Mass Term. Another extension would be to introduce a right-handed neutrino field ν_i^c , one for each neutrino flavor i ($i = e, \mu, \tau$), where, for example, the right-handed field for the electron neutrino is defined such that

ν_e^c annihilates a left-handed electron antineutrino $\bar{\nu}_{eL}$ and creates a right-handed electron neutrino ν_{eR} .

We could then define an interaction with the Higgs field exactly analogous to the interaction in (3) that gives electrons their mass:

$$\lambda_\nu \nu_e^c (\nu h^0 - e h^+) \quad . \quad (12)$$

Again, because the Higgs field h^0 has a nonzero vacuum expectation value, the interaction in (12) would give the neutrino a Dirac mass

$$m_\nu = \frac{\lambda_\nu v}{\sqrt{2}} \quad . \quad (13)$$

But why are neutrino masses much smaller than the masses of their charged lepton weak partners? Specifically, why is $m_\nu \ll m_e$? The electron mass is 500,000 eV, whereas from experiment, the electron neutrino mass is known to be less than 10 eV. The only explanation within the context of the interaction above is that the strength of the Yukawa coupling to the Higgs field is much greater for the electron than for the electron neutrino, that is, $\lambda_e > 5 \times 10^4 \lambda_\nu$. But this is not an explanation; it just parametrizes the obvious.

The Seesaw Mechanism and Majorana Neutrinos. The first real model of why neutrino masses are very much smaller than the masses of their lepton partners was provided by Murray Gell-Mann, Pierre Ramond, and Richard Slansky. Motivated by a class of theories that attempt to unify the interactions of the

Standard Model, including the strong interactions, they observed that, if one introduced the right-handed neutrino field ν_e^c into the Standard Model to form a Dirac mass term, one could also add a Majorana mass term of the form

$$\frac{1}{2} M \nu_e^c \nu_e^c \quad (14)$$

without violating the local symmetries of the Standard Model (as stated above, ν_e^c has no weak charge and is thus an invariant under the local symmetry). Further, if M were large enough, the mass of the left-handed neutrino would be small enough to satisfy the experimental bounds.

To see how this reduction occurs, we write the operators for both the Dirac mass term and the Majorana mass term:

$$\mathcal{L}_{\text{mass}} = \lambda_\nu (h^0 \nu_e - h^+ e) \nu_e^c + \frac{1}{2} M \nu_e^c \nu_e^c + \text{other terms} \quad . \quad (15)$$

Here we are assuming that $\lambda_\nu \cong \lambda_e$. These additions to the Lagrangian yield the following mass terms:

$$\mathcal{L}_{\nu_e \text{ mass}} = m_{\nu_e} \nu_e \nu_e^c + \frac{1}{2} M \nu_e^c \nu_e^c \quad , \quad (16)$$

where m_{ν_e} is the Dirac mass defined in (13), except that now we assume $\lambda_\nu \cong \lambda_e$, in which case $m_{\nu_e} \cong \lambda_e v / \sqrt{2}$. In other words, the Dirac neutrino mass is about equal to the electron mass (or some other fermion mass in the first family). The two neutrino mass terms may be rewritten as a matrix, frequently referred to as the mass matrix:

$$1/2 \begin{pmatrix} \nu_e & \nu_e^c \end{pmatrix} \begin{pmatrix} 0 & m_{\nu_e} \\ m_{\nu_e} & M \end{pmatrix} \begin{pmatrix} \nu_e \\ \nu_e^c \end{pmatrix} \quad . \quad (17)$$

It is clear that the fields ν_e and ν_e^c do not describe states of definite mass, or mass eigenstates, but rather the two fields are mixed by the interaction with the Higgs field. Diagonalizing this matrix yields the masses of the physical neutrinos. [The expressions in (16) and Equation (17) are equivalent. The proof requires more detail than is presented here.] One mass is very small:

$$\mu_{\text{light}} \approx \frac{m_{\nu_e}^2}{M} \quad . \quad (18)$$

It is the Dirac mass reduced by ratio m_{ν_e}/M that gave this mechanism its name—the “seesaw.” The second mass is very large:

$$\mu_{\text{heavy}} \approx M \quad . \quad (19)$$

The fields corresponding to these masses are given by

$$\nu_{\text{light}} \approx \nu_e + \left(\frac{m_{\nu_e}}{M} \right) \nu_e^c \approx \nu_e \quad , \quad (20)$$

and

$$\nu_{\text{heavy}} \approx \nu_e^c - \left(\frac{m_{\nu_e}}{M} \right) \nu_e \approx \nu_e^c \quad . \quad (21)$$

Both fields define Majorana particles, that is, particles that are their own antiparticles, and total-lepton-number conservation can be violated in processes involving these neutrinos. The light neutrino would correspond to the neutrino we see in the

weak processes observed so far, and is essentially the left-handed neutrino field ν_e . The right-handed neutrino field ν_e^c would not be observed directly at low energies. Its effect in the low-energy theory would only be visible as an effective neutrino mass operator, like the operator in (9), which would give the neutrino a very small mass and would signal the presence of a new scale of physics on the order of $M_{\text{effective}} = 2M/\lambda_{\nu}^2$ (see the box “The Seesaw Mechanism at Low Energies” on the facing page).

A New Higgs Isospin Triplet. Another possibility is that there are no right-handed neutrinos, but there is, instead, a new set of Higgs-type bosons ϕ that come in three varieties — $\phi^0, \phi^+, \phi^{++}$ — and transform as a triplet under the local weak isospin symmetry. The superscript denotes the electric charge of each boson. Using this Higgs triplet, we can introduce the interaction

$$\lambda_m(\nu\nu\phi^0 + \nu e\phi^+ + ee\phi^{++}) , \quad (22)$$

which is consistent with all Standard Model symmetries. If, in analogy with h^0 , the Higgs field ϕ^0 has a nonzero vacuum expectation value $\langle\phi^0\rangle = v_m$, the neutrino would also have a Majorana mass given by

$$\mu_{\nu} = \lambda_m\langle\phi^0\rangle = \lambda_m v_m , \quad (23)$$

where this fermion mass is a Majorana mass. In a theory with a Higgs triplet, the Higgs doublet is still necessary. In fact, in order to preserve the observed ratio of strengths of neutral- to charged-current interactions (equal to $1 \pm .01$), the vacuum expectation value v_m must be much smaller than in (3). Also, such a theory has a massless Nambu-Goldstone boson ϕ due to the spontaneous breaking of total lepton number, and it allows the process

$$\nu_{\mu} \rightarrow \nu_e + \phi . \quad (24)$$

Apart from the effective interaction in Equation (9), the other extensions we discussed introduce new states. Each makes predictions that can be tested. The Higgs triplet extension is the largest departure from the Standard Model. The seesaw mechanism is less intrusive than the Higgs triplet. In general, its only low-energy consequence is an arbitrary Majorana mass term for the three neutrino species given by

$$\mu_{ij}\nu_i\nu_j , \text{ where } i, j = e, \mu, \tau . \quad (25)$$

A general mass matrix such as the one in (25) would lead to lepton-family-number violating processes, CP (charge-conjugation/parity) violation, and neutrino oscillations. This simple hypothesis will be tested by present or proposed experiments.

On a final note, the new scale M in (15) can be very large. It may be associated with the proposed grand unification scale for strong, weak, and electromagnetic interactions, which is predicted to occur at energies on the order of 10^{16} GeV. If so, neutrino masses and mixings can give us information about the physics at this enormous energy scale. There is also the exciting possibility that, through a sequence of interactions that violate CP, lepton-number, and baryon-number conservation, the decay of the very heavy right-handed neutrino ν^c in the hot, early universe generates the observed baryon number of the universe, that is, the presence of matter as opposed to antimatter. ■

The Seesaw Mechanism at Low Energies

The seesaw mechanism for neutrino masses defines a new scale of nature given by M , the mass associated with the heavy right-handed neutrino ν_e^c . Since M is postulated to be very large, well above the energies accessible through experiment, it is interesting that the “effective” neutrino mass operator in (11) approximates the seesaw terms in (15) at energies below M . To show this, we consider the effective operator

$$\frac{1}{M_{\text{effective}}}(h^0\nu_e - h^+e)^2 .$$

When the Higgs vacuum expectation value is accounted for, this operator yields the nonrenormalizable mass term in diagram (a) and a Majorana mass given by

$$\mu_{\nu} = \frac{v^2}{M_{\text{effective}}}$$

In the seesaw mechanism, the light neutrino acquires its mass through the exchange of the heavy neutrino, as shown in diagram (b). Diagram (b), which is approximated by diagram (a) at energies below Mc^2 , is a renormalizable mass term that involves both Dirac and Majorana masses. It yields a neutrino mass

$$\mu_{\text{light}} = \frac{m_{\nu_e}^2}{M} \quad \text{with} \quad m_{\nu_e} \equiv \lambda_{\nu_e} \frac{v}{\sqrt{2}} .$$

Equating the values for μ_{ν} and μ_{light} , we obtain the relation between M and $M_{\text{effective}}$:

$$\frac{1}{M_{\text{effective}}} = \frac{(\lambda_{\nu_e})^2}{2M} .$$

At energies below M_W , the mass of the W boson, a similar type of relationship exists between Fermi’s “effective” theory shown in diagram (c) and the W -boson exchange processes shown in diagram (d). The exchange processes are defined by the gauge theory of the charged-current weak interactions. Fermi’s theory is a nonrenormalizable current-current interaction of the form

$$\mathcal{L}_{\text{Fermi}} = \frac{G_F}{\sqrt{2}} J_{\mu}^{\nu} J_{\mu}^{\nu\dagger} ,$$

where the weak current for the neutrino-electron doublet is given by

$$J_W^{\mu} = 2\nu_e^{\dagger} \bar{\sigma}^{\mu} e \quad \text{and} \quad \bar{\sigma}^{\mu} = (1, -\sigma^i) ,$$

and the Fermi constant G_F defines the strength of the effective interaction in diagram (c), as well as a new mass/energy scale of nature. The experimentally observed value is $G_F = 1.66 \times 10^{-5} \text{ GeV}^{-2}$. Equating the low-energy limit of diagram (c) with that of diagram (d) yields the formula

$$\frac{G_F}{\sqrt{2}} = \frac{g^2}{8M_W^2} ,$$

where g is the weak isospin coupling constant in the charged-current weak Lagrangian given by

$$\mathcal{L}_{\text{weak}} = -M_W^2 W^{\mu+} W_{\mu}^{-} + \frac{g}{2\sqrt{2}} W_{\mu}^{+} J_{\mu}^{\nu} + \frac{g}{2\sqrt{2}} W_{\mu}^{-} J_{\mu}^{\nu\dagger} .$$

This Lagrangian neglects the kinetic term for the W , which is a valid approximation at energies much less than the W boson mass.

(a) Effective neutrino mass term

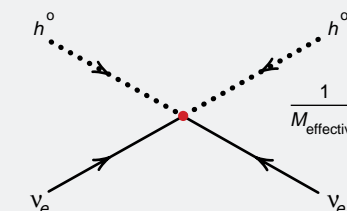

(b) Seesaw mass term for the light neutrino

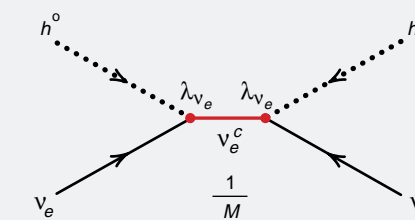

(c) Fermi’s current-current interaction

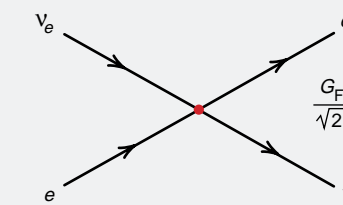

(d) Weak charged-current gauge interaction

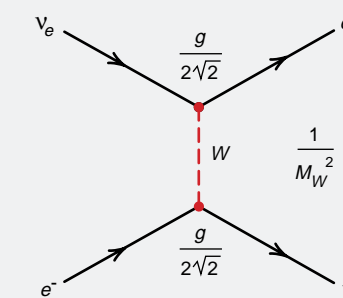

Family Mixing and the Origin of Mass

The difference between weak eigenstates and mass eigenstates

Stuart Raby

The Standard Model of elementary particle physics contains two disjoint sectors. The gauge sector describes the interactions of quarks and leptons (fermions, or spin-1/2 particles) with the spin-1 gauge bosons that mediate the strong, weak, and electromagnetic forces. This sector has great aesthetic appeal because the interactions are derived from local gauge symmetries. Also, the three families of quarks and leptons transform identically under those local symmetries and thus have the same basic strong, weak, and electromagnetic interactions.

The Higgs sector describes the interactions of the quarks and leptons with the spin-0 Higgs bosons h^+ and h^0 . This sector is somewhat ad hoc and contains many free parameters. The Higgs bosons were originally introduced to break the weak isospin gauge symmetry of the weak interactions by giving mass to the weak gauge bosons, the W and the Z^0 . The W and the Z^0 must be very heavy to explain why the weak force is so weak. But in the Standard Model, interactions with those Higgs bosons are also responsible for giving nonzero masses to the three families of quarks and leptons. Those interactions must yield different masses for the particles from different families and must cause the quarks from different families to mix, as observed in experiment. But neither the nine masses for the quarks and charged leptons nor the four parameters that specify the mixing of quarks across families are determined by any fundamental principle contained in the Standard Model. Instead, those thirteen parameters are determined from low-energy experiments and are matched to the free parameters in the Standard Model Lagrangian.

By definition, weak eigenstates are the members of the weak isospin doublets that transform into each other through interaction with the W boson (see Figure 5 on page 38). Mass eigenstates are states of definite mass created by the interaction with Higgs bosons. Those states describe freely propagating particles that are identified in detectors by their electric charge, mass, and spin quantum numbers. Since the Higgs interactions cause the quark weak eigenstates to mix with each other, the resulting mass eigenstates are not identical to the weak eigenstates.

Each set of eigenstates provides a description of the three families of quarks, and the two descriptions are related to each other by a set of unitary rotations. Most experimentalists are accustomed to seeing the Standard Model written in the mass eigenstate basis because the quarks of definite mass are the ingredients of protons, neutrons, and other metastable particles that the experimentalists measure. In the mass eigenstate basis, the Higgs interactions are diagonal, and the mixing across families appears in the gauge sector. In other words, the unitary rotations connecting the mass eigenstate basis to the weak eigenstate basis appear in the gauge interactions. Those rotation matrices could, in principle, appear in all the gauge interactions of quarks and leptons; but they do not. The Standard Model symmetries cause the rotation matrices to appear only in the quark charge-changing currents that couple to the W boson.

The specific product of rotation matrices that appears in the weak charge-changing currents is just what we call the CKM matrix, the unitary 3×3 mixing matrix deduced by Cabibbo, Kobayashi, and Maskawa. The elements in the CKM matrix have been determined by measuring, for example, the strengths of the strangeness-changing processes, in which a strange quark from the second family of mass states transforms into an up quark from the first family. So far, family mixing has not been observed among the leptons, with the possible

exception of neutrino oscillations. If oscillations are confirmed, the mixing angles measured in the neutrino experiments will become part of a CKM mixing matrix for the leptons.

This sidebar derives the form of the CKM matrix and shows how it reflects the difference between the rotation matrices for the up-type quarks ($Q = +2/3$) and those for their weak partners, the down-type quarks ($Q = -1/3$). This difference causes the family mixing in weak-interaction processes and is an example of the way in which the Higgs sector breaks the weak symmetry. We will also show that, because the neutrino masses are assumed to be degenerate (namely, zero), in the Standard Model, the rotation matrices for the neutrinos can be defined as identical to those for their weak partners, and therefore the CKM matrix for the leptons is the identity matrix. Thus, in the minimal Standard Model, in which neutrinos are massless, no family mixing can occur among the leptons, and individual-lepton-family number is conserved.

This discussion attributes the origin of mixing to the mismatch between weak eigenstates and mass eigenstates caused by the Higgs sector. A more fundamental understanding of mixing would require understanding the origin of fermion masses and the reason for certain symmetries, or approximate symmetries, to hold in nature. For example, a fundamental theory of fermion masses would have to explain why muon-family number is conserved, or only approximately conserved. It would also have to explain why the $K^0 - \bar{K}^0$ mixing amplitude is on the order of G_F^2 and not larger. The small amount of family mixing observed in nature puts severe constraints on any theory of fermion masses. Developing such a theory is an outstanding problem in particle physics, but it may require a significant extension of the Standard Model.

To discuss mixing as it appears in the Standard Model, it is necessary to explicitly write down the parts of the Standard Model Lagrangian that contain the Yukawa interactions between the fermions and the Higgs bosons (responsible for fermion masses) and the weak gauge interaction between the fermions and the W boson (responsible for charge-changing processes such as beta decay). But first, we must define some notation. As in the sidebar "Neutrino Masses" on page 64, we describe the fermion states by two-component left-handed Weyl spinors. Specifically, we have the fields u_i , d_i , u_i^c , d_i^c , e_i , ν_i , and e_i^c , where the family index i runs from one to three. The u_i are the fields for the three up-type quarks u , c , and t with electric charge $Q = +2/3$, the d_i are the fields for the three down-type quarks d , s , and b with $Q = -1/3$, the e_i stand for the three charged leptons e , μ , and τ with $Q = -1$, and the ν_i stand for the three neutrinos ν_e , ν_μ , and ν_τ with $Q = 0$. The fields u_i and u_i^c , for example, are defined as follows:

u_i annihilates the left-handed up-type quark u_L and creates the right-handed up-type antiquark \bar{u}_R in family i , and

u_i^c annihilates the left-handed up-type antiquark \bar{u}_L and creates the right-handed up-type quark u_R in family i .

To describe the Hermitian conjugate fields u_i^\dagger and $u_i^{c\dagger}$, interchange the words annihilate and create used above. Thus u_i , u_i^c , and their Hermitian conjugates describe the creation and annihilation of all the states of the up-type quarks. The down-type quark fields and the charged lepton fields are similarly defined. For the neutrinos, only the fields ν_i containing the states ν_L and $\bar{\nu}_R$ are observed; the fields ν_i^c are not included in the Standard Model. In other words, the Standard Model includes right-handed charged leptons, but it has no right-handed neutrinos (or left-handed antineutrinos).

The Weak Eigenstate Basis. We begin by defining the theory in terms of the weak eigenstates denoted by the subscript 0 and the color red. Specifically, the weak gauge coupling to the W is given by

$$\mathcal{L}_{\text{weak}} = +\frac{g}{\sqrt{2}}(W_{\mu}^{+} J^{\mu} + W_{\mu}^{-} J^{\mu\dagger}) , \quad (1)$$

where the charge-raising weak current J^{μ} is defined as

$$J^{\mu} = \sum_i u_{0i}^{\dagger} \bar{\sigma}^{\mu} d_{0i} + v_{0i}^{\dagger} \bar{\sigma}^{\mu} e_{0i} , \quad (2)$$

and the charge-lowering current $J^{\mu\dagger}$ is defined as

$$J^{\mu\dagger} = \sum_i d_{0i}^{\dagger} \bar{\sigma}^{\mu} u_{0i} + e_{0i}^{\dagger} \bar{\sigma}^{\mu} v_{0i} . \quad (3)$$

The constant g in Equation (1) specifies the strength of the weak interactions, and the $\bar{\sigma}^{\mu}$ is a four-component space-time vector given by $(1, -\sigma^j)$, where the σ^j are the standard Pauli spin matrices for spin-1/2 particles with $j = x, y, z$, the spatial directions. These 2×2 matrices act on the spin components of the spin-1/2 fields and are totally independent of the family index i . Each term in the charge-raising and charge-lowering currents connects states from the same family, which means the weak interactions in Equation (1) are diagonal in the weak eigenstate basis. In fact, those interactions define the weak eigenstates.

To understand the action of the currents, consider the first term, $u_{0i}^{\dagger} \bar{\sigma}^{\mu} d_{0i}$, in the charge-raising current J^{μ} . It annihilates a left-handed down quark and creates a left-handed up quark ($d_{0L} \rightarrow u_{0L}$) and, thereby, raises the electric charge by one unit. Electric charge is conserved because the W^{+} field creates a W^{-} (see top diagram at right). The first term in the charge-lowering current $J^{\mu\dagger}$ does the reverse: $d_{0i}^{\dagger} \bar{\sigma}^{\mu} u_{0i}$ annihilates a left-handed up quark and creates a left-handed down quark ($u_{0L} \rightarrow d_{0L}$) and, thereby, lowers the electric charge by one unit; at the same time, the W^{-} field creates a W^{+} (see bottom diagram at right). Thus, the members of each pair u_{0i} and d_{0i} transform into each other under the action of the charge-raising and charge-lowering weak currents and therefore are, by definition, a weak isospin doublet. The quark doublets are (u_0, d_0) , (c_0, s_0) , and (t_0, b_0) , and the lepton doublets are (ν_{e0}, e_0) , $(\nu_{\mu 0}, \mu_0)$, and $(\nu_{\tau 0}, \tau_0)$. The first member of the doublet has weak isotopic charge $I_3^W = +1/2$, and the second member has $I_3^W = -1/2$.

Finally, note that J^{μ} and $J^{\mu\dagger}$ are left-handed currents. They contain only the fermion fields f_0 and not the fermion fields f_0^c , which means that they create and annihilate only left-handed fermions f_{0L} (and right-handed antifermions \bar{f}_{0R}). The right-handed fermions f_{0R} (and left-handed antifermions \bar{f}_{0L}) are simply impervious to the charge-changing weak interactions, and therefore, the f_0^c are weak isotopic singlets. They are invariant under the weak isospin transformations.

Weak isospin symmetry, like strong isospin symmetry from nuclear physics and the symmetry of rotations, is an SU(2) symmetry, which means that there are three generators of the group of weak isospin symmetry transformations. Those generators have the same commutation relations as the Pauli spin matrices. (The Pauli matrices, shown at left, generate all the rotations of spin-1/2 particles.) The J^{μ} and $J^{\mu\dagger}$ are the raising and lowering generators of weak isospin analogous to σ^{+} and σ^{-} . The generator analogous to $1/2\sigma_3$ is J_3^{μ} given by

$$J_3^{\mu} = 1/2 \sum_i u_{0i}^{\dagger} \bar{\sigma}^{\mu} u_{0i} - d_{0i}^{\dagger} \bar{\sigma}^{\mu} d_{0i} + v_{0i}^{\dagger} \bar{\sigma}^{\mu} v_{0i} - e_{0i}^{\dagger} \bar{\sigma}^{\mu} e_{0i} , \quad (4)$$

and the time components of these three currents obey the commutation relations $[J^0, J^{0\dagger}] = 2J_3^0$. In general, the time component of a current is the charge

density, whereas the spatial component is the flux. Similarly, J_3^0 is the weak isotopic charge density. It contains terms of the form $f_0^{\dagger} f_0$, which are number operators N_f that count the number of f particles minus the number of \bar{f} antiparticles present. When this density is integrated over all space, it yields the weak isotopic charge I_3^W :

$$\int J_3^0(x) d^3x = I_3^W .$$

Now, let us consider the Higgs sector. The fermion fields interact with the Higgs weak isospin doublet (h^{+}, h^0) through the Yukawa interactions given by

$$\mathcal{L}_{\text{Yukawa}} = \sum_{i,j} u_{0i}^c (Y_{\text{up}})_{ij} [u_{0j} h^0 - d_{0j} h^{+}] + d_{0i}^c (Y_{\text{down}})_{ij} [u_{0j} (h^{+})^{\dagger} + d_{0j} (h^0)^{\dagger}] + e_{0i}^c (Y_{\text{lepton}})_{ij} [v_{0j} (h^{+})^{\dagger} + e_{0j} (h^0)^{\dagger}] ,$$

where Y_{up} , Y_{down} , and Y_{lepton} are the complex 3×3 Yukawa matrices that give the strengths of the interactions between the fermions and the Higgs bosons. Because the Higgs fields form a weak isospin doublet, each expression in brackets is an inner product of two weak doublets, making an isospin singlet. Thus, each term in the Lagrangian is invariant under the local weak isospin symmetry since the conjugate fields (for example, u_{0i}^c) are weak singlets. The lepton terms in Equation (5) are introduced in the sidebar “Neutrino Masses” (page 64), where masses are shown to arise directly from the Yukawa interactions because h^0 has a nonzero vacuum expectation value $\langle h^0 \rangle = v/\sqrt{2}$ that causes each type of fermion to feel an everpresent interaction. These interactions yield mass terms given by

$$\mathcal{L}_{\text{Yukawa}} \rightarrow \mathcal{L}_{\text{mass}} = u_{0i}^c (Y_{\text{up}})_{ij} u_{0j} \langle h^0 \rangle + d_{0i}^c (Y_{\text{down}})_{ij} d_{0j} \langle h^{0\dagger} \rangle + e_{0i}^c (Y_{\text{lepton}})_{ij} e_{0j} \langle h^{0\dagger} \rangle . \quad (6)$$

Notice that each term in $\mathcal{L}_{\text{mass}}$ contains a product of two fermion fields $f_0^c f_0$, which, by definition, annihilates a left-handed fermion and creates a right-handed fermion. Thus, these Yukawa interactions flip the handedness of fermions, a prerequisite for giving nonzero masses to the fermions. These terms resemble the Dirac mass terms introduced in the sidebar “Neutrino Masses,” except that the matrices Y_{up} , Y_{down} , and Y_{lepton} are *not* diagonal. Thus, in the weak eigenstate basis, the masses and the mixing across families occur in the Higgs sector.

The Mass Eigenstate Basis and the Higgs Sector. Let us examine the theory in the mass eigenstate basis. We find this basis by diagonalizing the Yukawa matrices in the mass terms of Equation (6). In general, each Yukawa matrix is diagonalized by two unitary 3×3 transformation matrices. For example, the diagonal Yukawa matrix for the up quarks \hat{Y}_{up} is given by

$$\hat{Y}_{\text{up}} = V_u^R Y_{\text{up}} V_u^{L\dagger} , \quad (7)$$

where matrix V_u^R acts on the right-handed up-type quarks in the fields u_{0i}^c , and matrix V_u^L acts on the left-handed up-type quarks in u_0 . The diagonal elements of \hat{Y}_{up} are $(\lambda_u, \lambda_c, \lambda_t)$, the Yukawa interaction strengths for all the up-type quarks: the up, charm, and top, respectively. Matrices \hat{Y}_{down} and \hat{Y}_{lepton} are similarly diagonalized. If u_0 and u_{0i}^c are the fields in the weak eigenstate, the fields in the mass eigenstate, u^c and u , are defined by the unitary transformations

$$u_{0i}^c = u^c V_u^R \quad \text{and} \quad u_0 = V_u^{L\dagger} u . \quad (8)$$

Since the V s are unitary transformations, $V^{\dagger}V = VV^{\dagger} = I$, we also have

The Pauli Matrices for Spin-1/2 Particles

The Pauli spin matrices generate all rotations of spin-1/2 particles.

Spin-1/2 particles have only two possible spin projections along, say the 3-axis: spin up, or $s_3 = +1/2$, and spin down, or $s_3 = -1/2$. The step-up operator σ^{+} raises spin down to spin up, the step-down operator σ^{-} lowers spin up to spin down, and σ_3 gives the value of the spin projection along the 3-axis. The basis set for the spin quantized along the 3-axis is given by

$$\begin{pmatrix} 1 \\ 0 \end{pmatrix} \quad \text{and} \quad \begin{pmatrix} 0 \\ 1 \end{pmatrix} ,$$

and the matrices are given by

$$\sigma^1 = \begin{pmatrix} 0 & 1 \\ 1 & 0 \end{pmatrix} \quad \sigma^2 = \begin{pmatrix} 0 & -i \\ i & 0 \end{pmatrix}$$

$$\sigma^3 = \begin{pmatrix} 1 & 0 \\ 0 & -1 \end{pmatrix} .$$

Defining the matrices σ^{\pm} as

$$\sigma^{\pm} = \frac{1}{2}(\sigma^1 \pm i\sigma^2) ,$$

one arrives at the following commutation relations:

$$[\sigma^3, \sigma^{\pm}] = \pm 2\sigma^{\pm} , \quad \text{and} \\ [\sigma^{+}, \sigma^{-}] = \sigma^3 .$$

The charge-raising weak interaction in the first family

$$(W_{\mu}^{+} J^{\mu})_{\text{first family}} = W_{\mu}^{+} u_0^{\dagger} \bar{\sigma}^{\mu} d_0 .$$

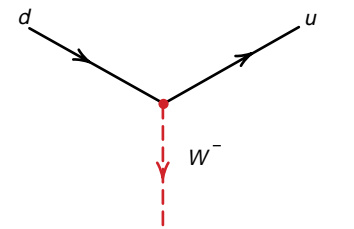

A down quark changes to an up quark with the emission of a W^{-} .

The charge-lowering weak interaction in the first family

$$(W_{\mu}^{-} J^{\mu\dagger})_{\text{first family}} = W_{\mu}^{-} d_0^{\dagger} \bar{\sigma}^{\mu} u_0 .$$

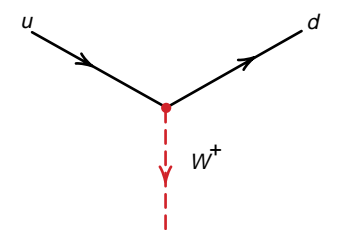

An up quark changes to a down quark with the emission of a W^{+} .

$$u^c = u^c_0 V_u^R{}^\dagger \text{ and } u = V_u^L u_0 .$$

In this new mass basis, $\mathcal{L}_{\text{mass}}$ in Equation (6) takes the form

$$\begin{aligned} \mathcal{L}_{\text{mass}} &= \sum_i u^c_i \hat{Y}_{\text{up}}^i u_i \langle h^0 \rangle + d_i^c \hat{Y}_{\text{down}}^i d_i \langle h^0 \rangle + e_i^c \hat{Y}_{\text{lepton}}^i e_i \langle h^0 \rangle \\ &= \sum_i u^c_i \hat{M}_{\text{up}}^i u_i + d_i^c \hat{M}_{\text{down}}^i d_i + e_i^c \hat{M}_{\text{lepton}}^i e_i , \end{aligned} \quad (9)$$

where the matrices $\hat{M}^i = \hat{Y}^i v/\sqrt{2}$ are diagonal, and the diagonal elements are just the masses of the fermions. In particular, we can write out the three terms for the up-type quarks u , c , and t :

$$\begin{aligned} \sum_i u^c_i \hat{M}_{\text{up}}^i u_i &= \lambda_u u^c u \langle h^0 \rangle + \lambda_c c^c c \langle h^0 \rangle + \lambda_t t^c t \langle h^0 \rangle \\ &= \lambda_u v/\sqrt{2} u^c u + \lambda_c v/\sqrt{2} c^c c + \lambda_t v/\sqrt{2} t^c t \\ &= m_u u^c u + m_c c^c c + m_t t^c t , \end{aligned} \quad (10)$$

with the masses of the up, charm, and top quarks given by

$$m_u = \lambda_u v/\sqrt{2}, \quad m_c = \lambda_c v/\sqrt{2}, \quad \text{and } m_t = \lambda_t v/\sqrt{2} .$$

Thus, the Higgs sector defines the mass eigenstate basis, and the diagonal elements of the mass matrices are the particle masses.

Mixing in the Mass Eigenstate Basis. Now, let us write the weak gauge interaction with the W in the mass eigenstate. Recall that

$$\mathcal{L}_{\text{weak}} = + \frac{g}{\sqrt{2}} (W_\mu^+ J^\mu + W_\mu^- J^{\mu\dagger}) ,$$

but to write the charge-raising weak current J^μ in the mass eigenstate, we substitute Equation (8) into Equation (2),

$$\begin{aligned} J^\mu &= \sum_i u_{0i}^\dagger \bar{\sigma}^\mu d_{0i} + \nu_{0i}^\dagger \bar{\sigma}^\mu e_{0i} \\ &= \sum_{i,k,j} u_i^\dagger (V_u^L)_{ik} \bar{\sigma}^\mu (V_d^L)_{kj} d_j + \nu_i^\dagger \bar{\sigma}^\mu e_i \\ &= \sum_{i,j} u_i^\dagger \bar{\sigma}^\mu (V_{\text{CKM}})_{ij} d_j + \nu_i^\dagger \bar{\sigma}^\mu e_i , \end{aligned} \quad (11)$$

and to rewrite the charge-lowering current $J^{\mu\dagger}$, we substitute Equation (8) into Equation (3):

$$\begin{aligned} J^{\mu\dagger} &= \sum_i d_{0i}^\dagger \bar{\sigma}^\mu u_{0i} + e_{0i}^\dagger \bar{\sigma}^\mu \nu_{0i} \\ &= \sum_{i,k,j} d_i^\dagger (V_d^L)_{ik} \bar{\sigma}^\mu (V_u^L)_{kj} u_j + e_i^\dagger \bar{\sigma}^\mu \nu_i \\ &= \sum_{i,j} d_i^\dagger \bar{\sigma}^\mu (V_{\text{CKM}})_{ij} u_j + e_i^\dagger \bar{\sigma}^\mu \nu_i , \end{aligned} \quad (12)$$

where
$$V_{\text{CKM}} = V_u^L V_d^L{}^\dagger . \quad (13)$$

Thus, the charge-raising and charge-lowering quark currents are *not* diagonal in the mass eigenstate basis. Instead, they contain the complex 3×3 mixing matrix V_{CKM} . This matrix would be the identity matrix were it not for the

difference between the rotation matrices for the up-type quarks V_u^L and those for the down-type quarks V_d^L . It is that difference that determines the amount of family mixing in weak-interaction processes. For that reason, all the mixing can be placed in either the up-type or down-type quarks, and by convention, the CKM matrix places all the mixing in the down-type quarks. The weak eigenstates for the down-type quarks are often defined as d' :

$$d' = V_{\text{CKM}} d = V_u^L V_d^L{}^\dagger d = V_u^L d_0 , \quad (14)$$

in which case, the up-type weak partners to d' become u' :

$$u' = V_u^L u_0 \equiv u .$$

When all the mixing is placed in the down-type quarks, the weak eigenstates for the up-type quarks are the same as the mass eigenstates. (We could just as easily place the mixing in the up-type quarks by defining a set of fields u' given in terms of the mass eigenstates u and V_{CKM} .) Independent of any convention, the weak currents J^μ couple quark mass eigenstates from different families. The form of the CKM matrix shows that, from the Higgs perspective, the up-type and down-type quarks look different. It is this mismatch that causes the mixing across quark families. If the rotation matrices for the up-type and down-type left-handed quarks were the same, that is, if $V_u^L = V_d^L$, the CKM matrix would be the identity matrix, and there would be no family mixing in weak-interaction processes. The existence of the CKM matrix is thus another example of the way in which the mass sector (through the Higgs mechanism) breaks the weak isospin symmetry. It also breaks nuclear isospin symmetry (the symmetry between up-type and down-type quarks), which acts symmetrically on left-handed and right-handed quarks.

Note that the mixing matrices V^R associated with the right-handed fermions do not enter into the Standard Model. They do, however, become relevant in extensions of the Standard Model, such as supersymmetric or left-right-symmetric models, and they can add to family-number violating processes.

Finally, we note that, because the neutrinos are assumed to be massless in the Standard Model, there is no mixing matrix for the leptons. In general, the leptonic analog to the CKM matrix has the form

$$V_{\text{lepton}} = V_\nu^L V_e^L{}^\dagger .$$

But we are free to choose any basis for the neutrinos because they all have the same mass. By choosing the rotation matrix for the neutrinos to be the same as that for the charged leptons $V_\nu^L = V_e^L$, we have

$$\nu_0 = V_e^L{}^\dagger \nu \text{ and } e_0 = V_e^L e .$$

The leptonic part of, for example, the charge-raising current is

$$\sum_i \nu_{0i}^\dagger \bar{\sigma}^\mu e_{0i} = \sum_{i,k,j} \nu_i^\dagger (V_e^L)_{ij} \bar{\sigma}^\mu (V_e^L)_{jk} e_k = \sum_i \nu_i^\dagger \bar{\sigma}^\mu e_i ,$$

and the leptonic analog of the CKM matrix is the identity matrix. This choice of eigenstate would not be possible, however, if neutrinos have different masses. On the contrary, the neutrinos would have a well-defined mass eigenstate and there would likely be a leptonic CKM matrix different from the identity matrix. It is this leptonic mixing matrix that would be responsible for neutrino oscillations as well as for family-number violating processes such as $\mu \rightarrow e + \gamma$. ■