

the march toward

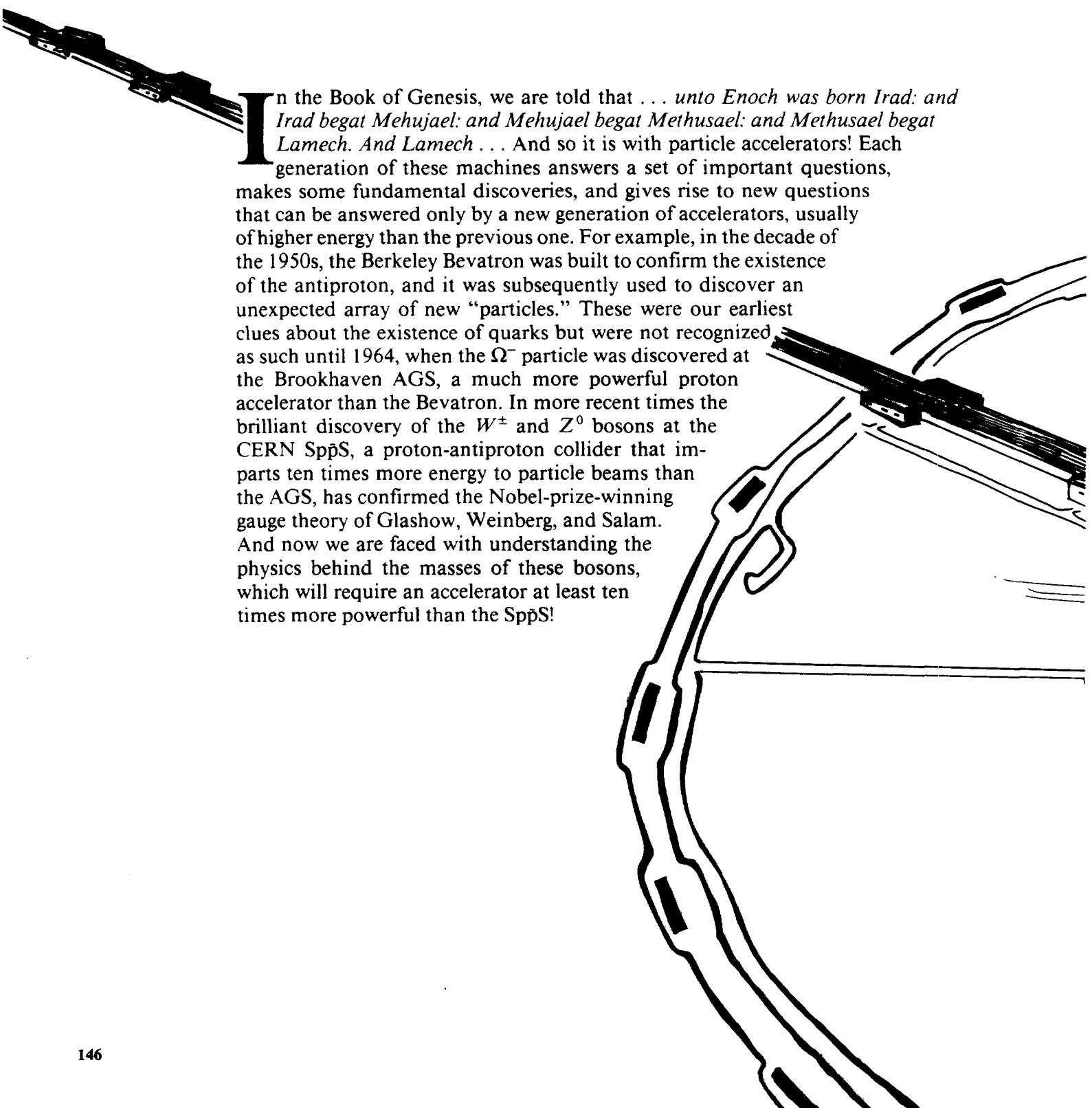

In the Book of Genesis, we are told that . . . *unto Enoch was born Irad: and Irad begat Mehujael: and Mehujael begat Methusael: and Methusael begat Lamech. And Lamech . . .* And so it is with particle accelerators! Each generation of these machines answers a set of important questions, makes some fundamental discoveries, and gives rise to new questions that can be answered only by a new generation of accelerators, usually of higher energy than the previous one. For example, in the decade of the 1950s, the Berkeley Bevatron was built to confirm the existence of the antiproton, and it was subsequently used to discover an unexpected array of new “particles.” These were our earliest clues about the existence of quarks but were not recognized as such until 1964, when the Ω^- particle was discovered at the Brookhaven AGS, a much more powerful proton accelerator than the Bevatron. In more recent times the brilliant discovery of the W^\pm and Z^0 bosons at the CERN Sp \bar{p} S, a proton-antiproton collider that imparts ten times more energy to particle beams than the AGS, has confirmed the Nobel-prize-winning gauge theory of Glashow, Weinberg, and Salam. And now we are faced with understanding the physics behind the masses of these bosons, which will require an accelerator at least ten times more powerful than the Sp \bar{p} S!

higher energies

by S. Peter Rosen



When these questions have been answered, we may expect the cycle to repeat itself until we run out of resources—or out of space. So far the field of particle physics has been fortunate: every time it seems to have reached the end of the energy line, some new technical development has come along to extend it into new realms. Synchrotrons such as the Bevatron and the Cosmotron, its sister and rival at Brookhaven, both represented an order-of-magnitude improvement over synchrocyclotrons, which in their time overcame relativistic problems to extend the energy of cyclotrons from tens of MeV into the hundreds. What allowed these developments was the synchronous principle invented independently by E. McMillan at Berkeley and V. Veksler in the Soviet Union.

In a cyclotron a proton travels in a circular orbit under the influence of a constant magnetic field. Every time it crosses a particular diameter, it receives an accelerating kick from an rf electric field oscillating at a constant frequency equal to the orbital frequency of the proton at some (low) kinetic energy. Increasing the kinetic energy of the proton increases the radius of its orbit but does not change its orbital frequency until the effects of the relativistic mass increase become significant. For this reason a cyclotron cannot efficiently accelerate protons to energies above about 20 MeV. The solution introduced by McMillan and Veksler was to vary the frequency of the rf field so that the proton and the field remained in synchronization. With such synchrocyclotrons proton energies of hundreds of MeV became accessible.

In a synchrotron the protons are confined to a narrow range of orbits during the entire acceleration cycle by varying also the magnetic field, and the magnetic field can then be supplied by a ring of magnets rather than by the solid circular magnet of a cyclotron. Nevertheless, the magnets in early synchrotrons were still very large, requiring 10,000 tons of iron in the case of the Bevatron, and for all practical purposes the synchrotron appeared to have reached its economic limit with this 6-GeV machine. Just at the right

time a group of accelerator physicists at Brookhaven invented the principle of “strong focusing,” and Ernest Courant, in May 1953, looked forward to the day when protons could be accelerated to 100 GeV—fifty times the energy available from the Cosmotron—with much smaller magnets! In the meantime Courant and his colleagues contented themselves with building a machine ten times more energetic, namely, the AGS (Alternating Gradient Synchrotron).

Courant proved to be most farsighted, but even his optimistic goal was far surpassed in the twenty years following the invention of strong focusing. The accelerator at Fermilab (Fermi National Accelerator Laboratory) achieved proton energies of 400 GeV in 1972, and at CERN (Organisation Européenne pour Recherche Nucléaire) the SPS (Super Proton Synchrotron) followed suit in 1976. Size is the most striking feature of these machines. Whereas the Bevatron had a circumference of 0.1 kilometer and could easily fit into a single building, the CERN and Fermilab accelerators have circumferences between 6 and 7 kilometers and are themselves hosts to large buildings.

Both the Fermilab accelerator and the SPS are capable of accelerating protons to 500 GeV, but prolonged operation at that energy is prohibited by excessive power costs. This economic hurdle has recently been overcome by the successful development of superconducting magnets. Fermilab has now installed a ring of superconducting magnets in the same tunnel that houses the original main ring and has achieved proton energies of 800 GeV, or close to 1 TeV. The success of the Tevatron, as it is called, has convinced the high-energy physics community that a 20-TeV proton accelerator is now within our technological grasp, and studies are under way to develop a proposal for such an accelerator, which would be between 90 and 160 kilometers in circumference. Whether this machine, known as the SSC (Superconducting Super Collider), will be the terminus of the energy line, only time will tell; but if the past is any guide, we can expect some-

thing to turn up. (See “The SSC—An Engineering Challenge.”)

Paralleling the higher and higher energy proton accelerators has been the development of electron accelerators. In the 1950s the emphasis was on linear accelerators, or linacs, in order to avoid the problem of energy loss by synchrotron radiation, which is much more serious for the electron than for the more massive proton. The development of linacs culminated in the two-mile-long accelerator at SLAC (Stanford Linear Accelerator Center), which today accelerates electrons to 40 GeV. This machine has had an enormous impact upon particle physics, both direct and indirect.

The direct impact includes the discovery of the “scaling” phenomenon in the late 1960s and of parity-violating electromagnetic forces in the late 1970s. By the scaling phenomenon is meant the behavior of electrons scattered off nucleons through very large angles: they appear to have been deflected by very hard, pointlike objects inside the nucleons. In exactly the same way that the experiments of Rutherford revealed the existence of an almost pointlike nucleus inside the atom, so the scaling experiments provided a major new piece of evidence for the existence of quarks. This evidence was further explored and extended in the '70s by neutrino experiments at Fermilab and CERN.

Whereas the scaling phenomenon opened a new vista on the physics of nucleons, the 1978 discovery of parity violation in the scattering of polarized electrons by deuterons and protons closed a chapter in the history of weak interactions. In 1973 the phenomenon of weak neutral currents had been discovered in neutrino reactions at the CERN PS (Proton Synchrotron), an accelerator very similar in energy to the AGS. This discovery constituted strong evidence in favor of the Glashow-Weinberg-Salam theory unifying electromagnetic and weak interactions. During the next five years more and more favorable evidence accumulated until only one vital piece was missing—the demonstration of parity violation in electron-nucleon

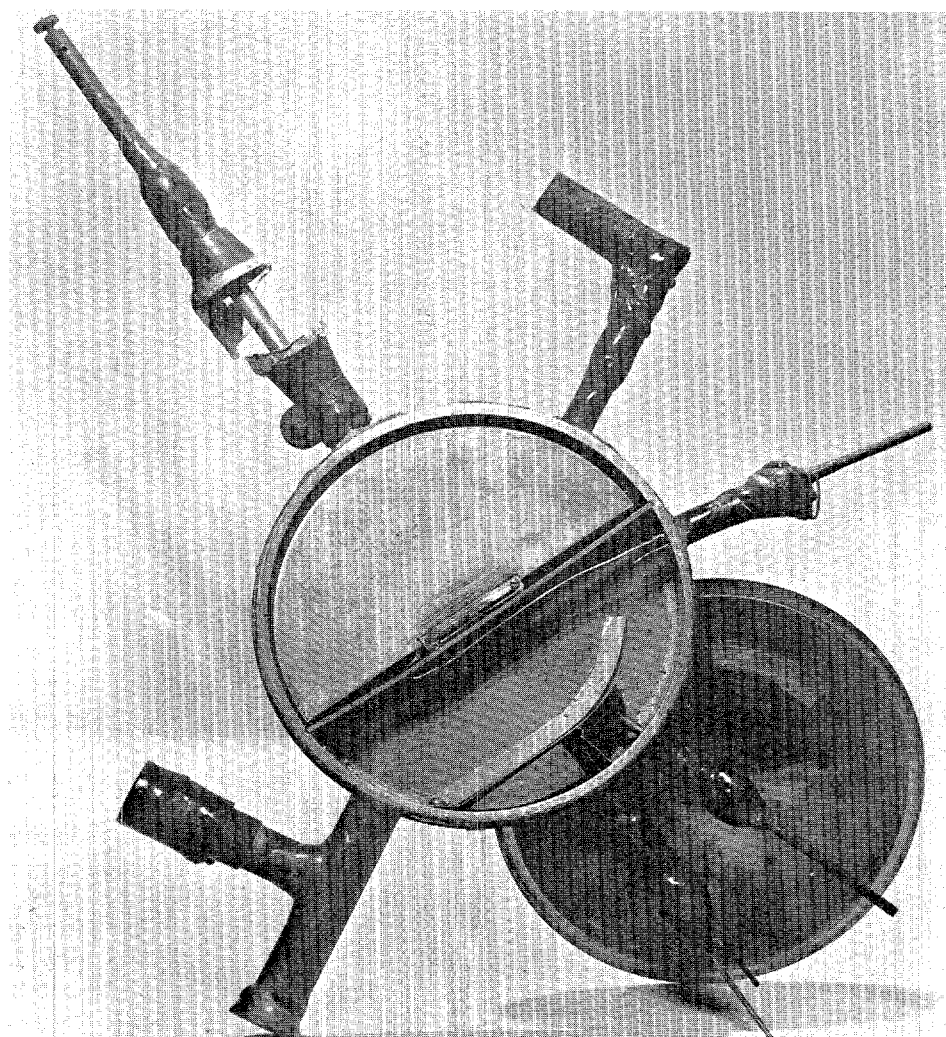

The “string and sealing wax” version of a cyclotron. With this 4-inch device E. O. Lawrence and graduate student M. S. Livingston successfully demonstrated the feasibility of the cyclotron principle on January 2, 1931. The device accelerated protons to 80 keV. (Photo courtesy of Lawrence Berkeley Laboratory.)

reactions at a very small, but precisely predicted, level. In a brilliant experiment C. Prescott and R. Taylor and their colleagues found the missing link and thereby set the seal on the unification of weak and electromagnetic interactions.

A less direct but equally significant impact of the two-mile linac arose from the electron-positron storage ring known as SPEAR

(Stanford Positron Electron Accelerating Ring). Electrons and positrons from the linac are accumulated in two counterrotating beams in a circular ring of magnets and shielding, which, from the outside, looks like a reconstruction of Stonehenge. Inside, enough rf power is supplied to overcome synchrotron radiation losses and to allow some modest acceleration from about 1 to 4

GeV per beam. In the fall of 1974, the ψ particle, which provided the first evidence for the fourth, or charmed, quark was found among the products of electron-positron collisions at SPEAR; at the same time the J particle, exactly the same object as ψ , was discovered in proton collisions at the AGS. With the advent of J/ψ , the point of view that all hadrons are made of quarks gained universal acceptance. (The up, down, and strange quarks had been “found” experimentally; the existence of the charmed quark had been postulated in 1964 by Glashow and J. Bjorken to equalize the number of quarks and leptons and again in 1970 by Glashow, J. Iliopoulos, and L. Maiani to explain the apparent nonoccurrence of strangeness-changing neutral currents.

The discovery of J/ψ , together with the discovery of neutral currents the year before, revitalized the entire field of high-energy physics. In particular, it set the building of electron-positron storage rings going with a vengeance! Plans were immediately laid at SLAC for PEP (Positron Electron Project), a larger storage ring capable of producing 18-GeV beams of electrons and positrons, and in Hamburg, home of DORIS (Doppel-Ring-Speicher), the European counterpart of SPEAR, a 19-GeV storage ring named PETRA (Positron Electron Tandem Ring Accelerator) was designed. Subsequently a third storage ring producing 8-GeV beams of positrons and electrons was built at Cornell; it goes by the name of CESR (Cornell Electron Storage Ring).

Although the gluon, the gauge boson of quantum chromodynamics, was discovered at PETRA, and the surprisingly long lifetime of the b quark was established at PEP, the most interesting energy range turned out to be occupied by CESR. Very shortly before this machine became operative, L. Lederman and his coworkers, in an experiment at Fermilab similar to the J experiment at Brookhaven, discovered the Υ particle at 9.4 GeV; it is the b -quark analogue of J/ψ at 3.1 GeV. By good fortune CESR is in just the right energy range to explore the properties of the Υ system, just as SPEAR was able to

elucidate the ψ system. Many interesting results about Υ , its excited states, and mesons containing the b quark are emerging from this unique facility at Cornell.

The next round for positrons and electrons includes two new machines, one a CERN storage ring called LEP (Large Electron-Positron) and the other a novel facility at SLAC called SLC (Stanford Linear Collider). LEP will be located about 800 meters under the Jura Mountains and will have a circumference of 30 kilometers. Providing 86-GeV electron and positron beams initially and later 130-GeV beams, this machine will be an excellent tool for exploring the properties of the W^\pm bosons. SLC is an attempt to overcome the problem of synchrotron radiation losses by causing two *linear* beams to collide head on. If successful, this scheme could well establish the basic design for future machines of extremely high energy. At present SLC is expected to operate at 50 GeV per beam, an ideal energy with which to study the Z^0 boson.

High energy is not the only frontier against which accelerators are pushing. Here at Los Alamos LAMPF (Los Alamos Meson Physics Facility) has been the scene of pioneering work on the frontier of high intensity for more than ten years. At present this 800-MeV proton linac carries an average current of 1 milliampere. To emphasize just how great an intensity that is, we note that most of the accelerators mentioned above hardly ever attain an average current of 10 microamperes. LAMPF is one of three so-called meson factories in the world; the other two are highly advanced synchrocyclotrons at TRIUMF (Tri-University Meson Facility) in Vancouver, Canada, and at SIN (Schweizerisches Institut für Nuklearforschung) near Zurich, Switzerland.

The high intensity available at LAMPF has given rise to fundamental contributions in nuclear physics, including confirmation of the recently developed Dirac formulation of nucleon-nucleus interactions and discovery of giant collective excitations in nuclei. In addition, its copious muon and neutrino



A state-of-the art version of a proton synchrotron. Here at Fermilab protons will be accelerated to an energy close to 1 TeV in a 6562-foot-diameter ring of superconducting magnets. Wilson Hall, headquarters of the laboratory and a fitting monument to a master accelerator builder, appears at the lower left. (Photo courtesy of Fermi National Accelerator Laboratory.)

beams have been applied to advantage in particle physics, especially in the areas of rare modes of particle decay and neutrino physics.

The search for rare decay modes (such as $\mu^+ \rightarrow e^+ + \gamma$) remains high on the agenda of particle physics because our present failure to see them indicates that certain conservation laws seem to be valid. Grand unified theories of strong and electroweak interactions tell us that, apart from energy and momentum, the only strictly conserved quantity is electric charge. According to these theories, the conservation of all other quantities, including lepton number and baryon number, is only approximate, and violations of these conservation laws must occur, although perhaps at levels the minutest of the minute.

Meson factories are ideally suited to the search for rare processes, and here at Los Alamos, at TRIUMF, and at SIN plans are being drawn up to extend the range of present machines from pions to kaons. (See "LAMPF II and the High-Intensity Frontier.") Several rare decays of kaons can provide important insights into grand uni-

fied theories, as well as into theories that address the question of W^\pm and Z^0 masses, and so the search for them can be expected to warm up in the next few years.

Another reason for studying kaon decays is CP violation, a phenomenon discovered twenty years ago at the AGS and still today not well understood. Because the effects of CP violation have been detected only in kaon decays and nowhere else, extremely precise measurements of the relevant parameters are needed to help determine the underlying cause. In this case too, kaon factories are very well suited to attack a fundamental problem of particle physics.

In the area of neutrino physics, LAMPF has made important studies of the identity of neutrinos emitted in muon decay and is now engaged in a pioneering study of neutrino-electron scattering. High-precision measurements of the cross section are needed as a test of the Glashow-Weinberg-Salam theory and are likely to be a major part of the experimental program at kaon factories.

While the main thrust of particle physics has always been carried by accelerator-based

experiments, there are, and there have always been, important experiments performed without accelerators. The first evidence for strange particles was found in the late 1940s in photographic emulsions exposed to cosmic rays, and in 1956 the neutrino was first detected in an experiment at a nuclear reactor. In both cases accelerators took up these discoveries to explore and extend them as far as possible.

Another example is the discovery of parity nonconservation in late 1956. The original impetus came from the famous τ - θ puzzle concerning the decay of K mesons into two and three pions, and it had its origins in accelerator-based experiments. But the definitive experiment that demonstrated the nonconservation of parity involved the beta decay of cobalt-60. Further studies of nuclear beta decay led to a beautiful clarification of the Fermi theory of weak interactions and laid the foundations for modern gauge theories. The history of this era reveals a remarkable interplay between accelerator and non-accelerator experiments.

In more recent times the solar neutrino experiment carried out by R. Davis and his colleagues deep in a gold mine provided the original motivation for the idea of neutrino oscillations. Other experiments deep underground have set lower limits of order 10^{32} years on the lifetime of the proton and may yet reveal that "diamonds are not forever."

And the limits set at reactors on the electric dipole moment of the neutron have proved to be a most rigorous test for the many models of CP violation that have been proposed.

In 1958, a time of much expansion and optimism for the future, Robert R. Wilson, the master accelerator builder, compared the building of particle accelerators in this century with the building of great cathedrals in 12th and 13th century France. And just as the cathedral builders thrust upward toward Heaven with all the technical prowess at their command, so the accelerator builders strive to extract ever more energy from their mighty machines. Just as the cathedral builders sought to be among the Heavenly Hosts, bathed in the radiance of Eternal Light, so the accelerator builders seek to unlock the deepest secrets of Nature and live in a state of Perpetual Enlightenment:

*Ah, but a man's reach should exceed
his grasp,
Or what's a heaven for?*

Robert Browning

Wilson went on to build his great accelerator, and his cathedral too, at Fermilab near Batavia, Illinois. In its time, the early to mid 1970s, the main ring at Fermilab was the

most powerful accelerator in the world, and it will soon regain that honor as the Tevatron begins to operate. The central laboratory building, Wilson Hall, rises up to sixteen stories like a pair of hands joined in prayer, and it stands upon the plain of northcentral Illinois much as York Minster stands upon the plain of York in England, visible for miles around. Some wag once dubbed the laboratory building "Minster Wilson, or the Cathedral of St. Robert," and he observed that the quadrupole logo of Fermilab should be called "the Cross of Batavia." But Wilson Hall serves to remind the citizens of northern Illinois that science is ever present in their lives, just as York Minster reassured the peasants of medieval Yorkshire that God was always nearby.

The times we live in are much less optimistic than those when Wilson first made his comparison, and our resources are no longer as plentiful for our needs. But we may draw comfort from the search for a few nuggets of truth in an uncertain world.

*To gaze up from the ruins of the
oppressive present towards the stars is
to recognise the indestructible world of
laws, to strengthen faith in reason, to
realise the "harmonia mundi" that
transfuses all phenomena, and that
never has been, nor will be, disturbed.*

Hermann Weyl, 1919

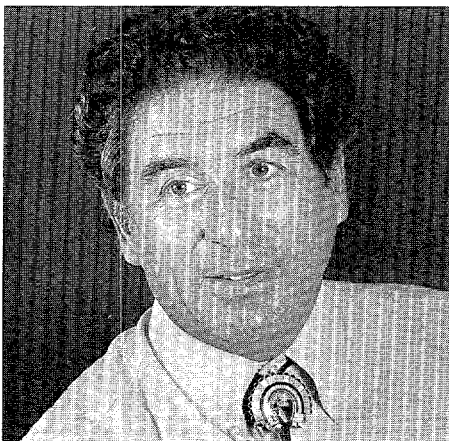

S. Peter Rosen, a native of London, was educated at Merton College, Oxford, receiving from that institution a B.S. in mathematics in 1954 and both an M.A. and D.Phil. in theoretical physics in 1957. Peter first came to this country as a Research Associate at Washington University and then worked as Scientist for the Midwestern Universities Research Association at Madison, Wisconsin. A NATO Fellowship took him to the Clarendon Laboratory at Oxford in 1961. He then returned to the United States to Purdue University, where he retains a professorship in physics. Peter has served as Senior Theoretical Physicist for the U.S. Energy Research and Development Administration's High Energy Physics Program, as Program Associate for Theoretical Physics with the National Science Foundation, and as Chairman of the U.S. Department of Energy's Technical Assessment Panel for Proton Decay and on the Governing Board for the Lewes Center for Physics in Delaware. His association with the Laboratory extends back to 1977 when he came as Visiting Staff Member. He has served as Consultant with the Theoretical Division and as a member of the Program Advisory Committee and Chairman of the Neutrino Subcommittee of LAMPF. He is currently Associate Division Leader for Nuclear and Particle Physics of the Theoretical Division. Peter's research specialties are symmetries of elementary particles and the theory of weak interactions.

LAMPF II and the High-Intensity Frontier

by Henry A. Thiessen

A small Los Alamos group has spent the past two years planning an addition to LAMPF, the 800-MeV, 1-milliampere proton linac on Mesita de Los Alamos. Dubbed LAMPF II and consisting of two high-current synchrotrons fed by LAMPF, the addition will provide beams of protons with a maximum energy of 45 GeV and a maximum current of 200 microamperes. Compared to its best existing competitor, the AGS at Brookhaven National Laboratory, LAMPF II will produce approximately 90 times more neutrinos, 300 times more kaons, and 1000 times more antiprotons. Figure 1 shows a layout of the proposed facility.

Why Do We Need LAMPF II?

The new accelerator will continue the tradition set by LAMPF of operating in the intersection region between nuclear physics and particle physics. Other articles in this issue ("The Family Problem" and "Experiments To Test Unification Schemes") have discussed crucial experiments in particle physics that require high-intensity beams of secondary particles. For example, the large mass estimated for a "family vector boson" implies that, now and for the foreseeable future, the possibility of family-changing interactions can be in-

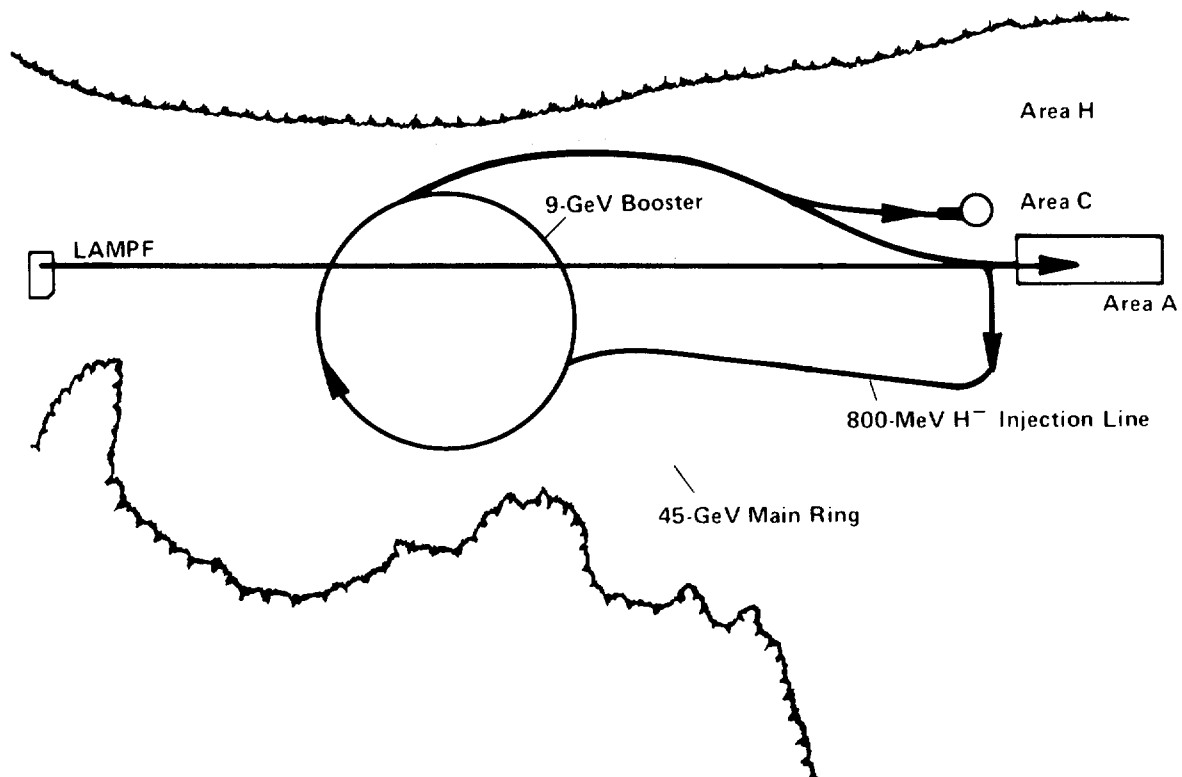

Fig. 1. LAMPF II, the proposed addition to LAMPF, is designed to produce proton beams with a maximum energy of 45 GeV and a maximum current of 200 microamperes. These proton beams will provide intense beams of antiprotons, kaons, muons, and neutrinos for use in experiments important to both particle and nuclear physics. The addition consists of two synchrotrons, both located 20 meters below the existing LAMPF linac. The booster (red) is a 9-GeV, 60

hertz, 200-microampere machine fed by LAMPF, and the main ring (blue) is a 45-GeV, 6-hertz, 40-microampere machine. Proton beams will be delivered to the main experimental area of LAMPF (Area A) and to an area for experiments with neutrino beams and short, pulsed beams of other secondary particles (Area C). A new area for experiments with high-energy secondary beams (Area H) will be constructed to make full use of the 45-GeV proton beam.

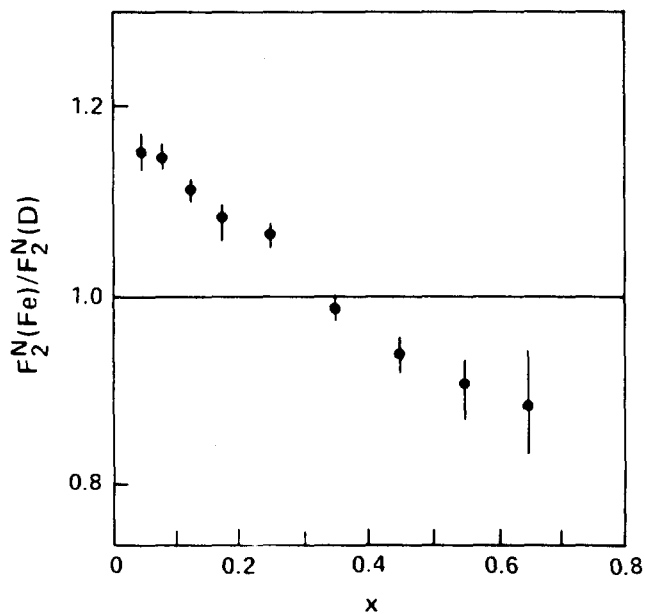

Fig. 2. The "EMC effect" was first observed in data on the scattering of muons from deuterium and iron nuclei at high momentum transfer. The ratio of the two nucleon structure functions ($F_2^N(\text{Fe})$ and $F_2^N(\text{D})$) deduced from these data by regarding a nucleus as simply a collection of nucleons is shown above as a function of x , a parameter representing the fraction of the momentum carried by the nucleon struck in the collision. The observed variation of the ratio from unity is quite contrary to expectations; it can be interpreted as a manifestation of the quark substructure of the nucleons within a nucleus. (Adapted from J. J. Aubert et al. (*The European Muon Collaboration*), *Physics Letters* 123B(1983):175.)

investigated only with high-intensity beams of kaons and muons. And studies of neutrino masses and neutrino-electron scattering, which are among the most important tests of possible extensions of the standard model, demand high-intensity beams of neutrinos to compensate for the notorious infrequency of their interactions.

Here I take the opportunity to discuss some of the experiments in nuclear physics that can be addressed at LAMPF II. The examples

will include the search for quark effects with the Drell-Yan process, the production of quark-gluon plasma by annihilation of antiprotons in nuclei, the extraction of nuclear properties from hypernuclei, and low-energy tests of quantum chromodynamics.

Quark Effects. A major problem facing today's generation of nuclear physicists is to develop a model of the nucleus in terms of its fundamental constituents—quarks and gluons. In terms of nucleons the venerable nuclear shell model has been as successful at interpreting nuclear phenomena as its analogue, the atomic shell model, has been at interpreting the structure and chemistry of atoms. But nucleons are known to be made of quarks and gluons and thus must possess some additional internal degrees of freedom. Can we see some of the effects of these additional degrees of freedom? And then can we use these observations to construct a theory of nuclei based on quarks and gluons?

Defining an experiment to answer the first question is difficult for two reasons. First, we know from the success of the shell model that nucleons dominate the observable properties of nuclei, and when this model fails, the facts can still be explained in terms of the exchange of pions or other mesons between the nucleons. Second, the current theory of quarks and gluons (quantum chromodynamics, or QCD) is simple only in the limit of extremely high energy and extremely high momentum transfer, the domain of "asymptotic QCD." But the world of nuclear physics is very far from that domain. Thus, theoretical guidance from the more complicated domain of low-energy QCD is sparse.

To date no phenomenon has been observed that can be interpreted unambiguously as an effect of the quark-gluon substructure of nucleons. However, the results of an experiment at CERN by the "European Muon Collaboration"¹ are a good candidate for a quark effect, although other explanations are possible. This group determined the nuclear structure functions for iron and deuterium from data on the inelastic scattering of muons at high momentum transfers. (A nuclear structure function is a multiplicative correction to the Mott cross section; it is indicative of the momentum distribution of the quarks within the nucleus.) From these structure functions they then inferred values for the nucleon structure function by assuming that the nucleus is simply a collection of nucleons. (If this assumption were true, the inferred nucleon structure function would not vary from nucleus to nucleus.) Their results (Fig. 2) imply that an iron nucleus contains more high-momentum quarks and fewer low-momentum quarks than does deuterium. This was quite unexpected but was quickly corroborated by a re-analysis² of some ten-year-old electron-scattering data from SLAC and has now been confirmed in great detail by several new experiments.^{3,4} The facts are clear, but how are they to be interpreted?

The larger number of low-momentum quarks in iron than in deuterium may mean that the quarks in iron are sharing their momenta, perhaps with other quarks through formation of, say, six-

quark states. Another interpretation, that iron contains many more pions acting as nuclear "glue" than does deuterium, has already been discounted by the results of a LAMPF experiment on the scattering of polarized protons from hydrogen and lead.⁵ Whatever the final interpretation of the "EMC effect" may be, it clearly indicates that the internal structure of the nucleon changes in the nucleus.

Interpretation of the EMC effect is complicated by the fact that the contribution of the "valence" quarks (the three quarks that predominantly make up a nucleon) to the lepton-scattering amplitude is not distinguishable from the contribution of the "sea" quarks (the virtual quark-antiquark pairs that can exist within the nucleon for short times). One way to sort out these contributions is to measure the amplitude for production of lepton-antilepton pairs in high-energy hadron-hadron collisions.⁶ When the momentum of the lepton-antilepton pair transverse to the hadron beam is small, the dominant amplitude for this Drell-Yan process arises from the annihilation of a quark and an antiquark into a photon, which then decays into the lepton-antilepton pair (Fig. 3). Since valence and sea quarks from different hadronic probes make different contributions to the amplitude, measurement of these differences with the 45-GeV proton beam of LAMPF II and its secondary beams of pions, kaons, and antiprotons can help to decide among the possible explanations of the EMC effect.

Quark-Gluon Plasma. Quantum chromodynamics predicts that at a sufficiently high temperature or density the vacuum can turn into a state of quarks, antiquarks, and gluons called quark-gluon plasma. (Such a plasma is expected to have been formed in the first few microseconds after the creation of the universe.) The present generation of relativistic heavy-ion experiments is designed to produce this plasma by achieving high density. However, since the predicted uncertainty in the transition temperature is much smaller than the predicted uncertainty in the transition density, achieving high temperature is regarded as the better approach to producing such a plasma.

D. Strottman and W. Gibbs of Los Alamos have investigated the possibility of heating a nucleus to the required high temperature by annihilation of high-energy antiprotons within the nucleus.⁷ The results of a calculation by Strottman (Fig. 4), which were based on a hydrodynamic model, indicate that in a nearly head-on collision between a 10-GeV antiproton and a uranium nucleus, most of the available energy is deposited within the nucleus, raising its temperature to that necessary for formation of the quark-gluon plasma. Gibbs has performed such a calculation with the intranuclear cascade model and obtained very similar results.

Like relativistic heavy-ion experiments, such antiproton experiments pose two problems: isolating from among many events the rare head-on collisions and finding a signature of the transition to plasma. The high intensity of antiprotons to be available at LAMPF II will

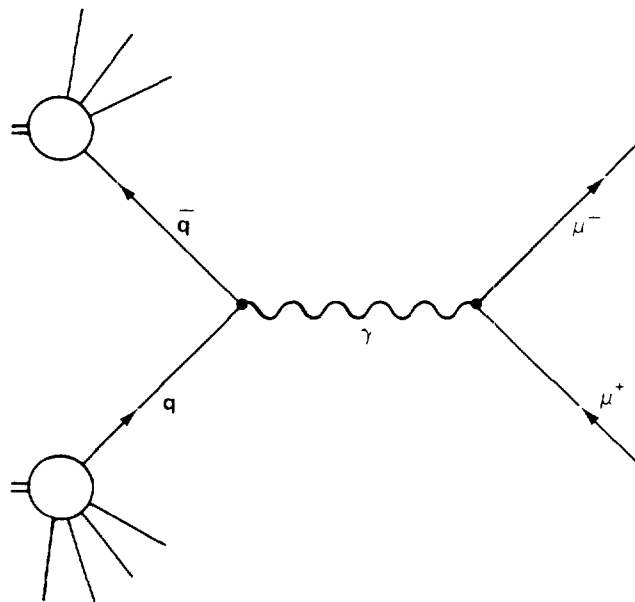

Fig. 3. The Drell-Yan process is the name given to the production of a lepton-antilepton pair in a collision between two hadrons. When the momentum of the lepton pair transverse to the projectile hadron is small, the dominant amplitude for the Drell-Yan process arises from the interaction pictured above: a quark and an antiquark from the two hadrons annihilate to form a photon, which then decays into the lepton-antilepton pair (here shown as a muon-antimuon pair).

help solve these problems by providing large numbers of events for study.

Nuclear Properties from Hypernuclei. A "hypernucleus" is a nucleus in which a neutron is replaced by a strange heavy baryon, the Lambda (Λ). (The valence-quark composition of a neutron is udd , and that of a Λ is uds .) Such hypernuclei are produced in collisions of kaons with ordinary nuclei. The properties of hypernuclei are accessible to measurement because their lifetimes are relatively long (similar to that of the free Λ , about 10^{-10} second). These properties provide information about the forces among the nucleons with the nucleus. In fact, the Λ plays a role in studies of the nuclear environment similar

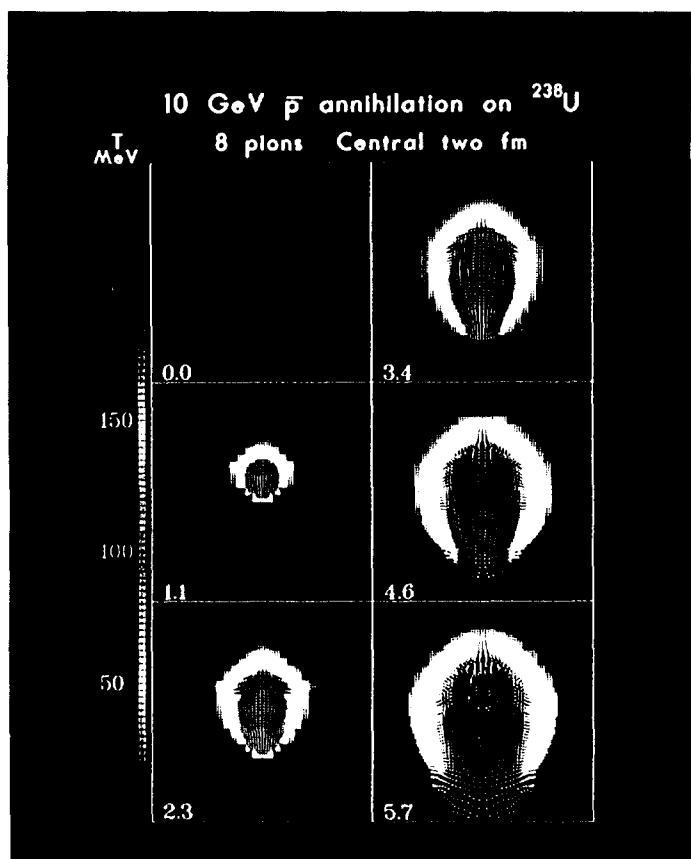

Fig. 4. A color-coded computer-graphic display of the temperature (in MeV) within a uranium-238 nucleus at various times (in 10^{-23} second) after annihilation of a 10-GeV antiproton with a nucleon. (The temperatures were calculated by D. Strottman on the basis of a hydrodynamic model.) Annihilation of the antiproton produces approximately eight pions with a mean momentum of 1.2 GeV/c. Interaction of these pions with the nucleus significantly increases the temperature of the central region of the nucleus (third frame). This hot region expands, and finally energy begins to escape from the nucleus (sixth frame). The temperatures achieved are sufficiently high for formation of a predicted state of matter known as quark-gluon plasma.

Pauli exclusion principle would not be applicable.) The energy levels of these hypernuclei would be indicative of the nuclear potential in the interior of the nucleus, a property that is otherwise difficult to measure.

A particularly interesting feature of the light hypernuclei is the nearly zero value of the spin-orbit interaction between the Λ and the nucleus.^{8,9,10,11} Although this result was completely unexpected, it has since been explained in terms of both a valence-quark model of the baryons and a conventional meson-exchange model of nuclear forces. However, these two "orthogonal" descriptions of nuclear matter yield very different predictions for the spin-orbit interaction between the Σ (another strange baryon) and the nucleus. Data that might distinguish between the two models has yet to be taken.

Most experimentalists working in the field of hypernuclei are hampered by the low intensity and poor energy definition of the kaon beams available at existing accelerators. The much higher intensity and better energy definition of the kaon beams to be provided by LAMPF II will greatly benefit this field.

Low-Energy Tests of QCD. A striking prediction of QCD is the existence of "glueballs," bound states containing only gluons. Also predicted are bound states containing mixtures of quarks and gluons, known as meiktons or hermaphrodites. These objects, if they exist, should be produced in hadron-nucleon collisions. However, since they are predicted to occur in a region already populated by a large number of hadrons, finding them will be a difficult job, requiring detailed phase-shift analyses of exclusive few-body channels in the predicted region. The high-intensity beams of LAMPF II, especially the pure kaon beams, will be extremely useful in searches for glueballs and meiktons.

Another expectation based on QCD is the near absence of polarization effects in inelastic hadron-nucleon scattering. But the few experiments on the exclusive channels at high momentum transfer have revealed strong polarization effects.¹² In contrast, the quark counting rules of QCD for the energy dependence of the elastic scattering cross section have been observed to be valid, even though the theory is not applicable in this energy regime. The challenge to both theory and experiment is to find out why some facets of QCD agree with experiment when they are not expected to, and vice versa. Obviously, more data are needed.

Also needed are more data on hadron spectroscopy, particularly in the area of kaon-nucleon scattering, which has received little attention for more than a decade. Such data are needed to help guide the development of quark-confinement theories.

LAMPF II Design

LAMPF II was designed with two goals in mind: production of a 45-GeV, 40-microampere proton beam as economically as possible,

and minimum disruption to the ongoing experimental programs at LAMPF. The designs of both of the new synchrotrons reflect these goals.

The booster, or first stage, will be fed by the world's best H^- injector, LAMPF. This booster will provide a 9-GeV, 200-microampere beam of protons at 60 hertz. The 200-microampere current is the maximum consistent with continued use of the 800-MeV LAMPF beam by the Weapons Neutron Research Facility and the Proton Storage Ring. The 9-GeV energy is ideal not only for injection into the second stage but also for production of neutrinos to be used in scattering experiments (Fig. 5). Eighty percent of the booster current will be dedicated to the neutrino program. In contrast, the booster stage at other accelerators usually sits idle between pulses in the main ring. Since the phase space of the LAMPF beam is smaller in all six dimensions than the injection requirements of LAMPF II, lossless injection at a correct phase space is straightforward.

The 45-GeV main ring is shaped like a racetrack for two reasons: it fits nicely on the long, narrow mesa site and it provides the long straight sections necessary for efficient slow extraction. The main ring is basically a 12-hertz machine but will be operated at 6 hertz to permit slow extraction of a beam at a duty factor of 50 percent. This compromise minimizes the initial cost yet preserves the option of doubling the current and increasing the duty factor by adding a stretcher at a later date. The 45-GeV proton energy will provide kaons and antiprotons with energies up to 25 GeV. Such high energies should prove especially useful for the experiments mentioned above on the Drell-Yan process and exclusive hadron interactions.

The booster has a second operating mode: 12 GeV at 30 hertz and 100 microamperes with a duty factor of 30 percent. This 12-GeV mode will be useful for producing kaons in the early years if the main ring is delayed for financial reasons.

The most difficult technical problem posed by LAMPF II is the rf system, which must provide up to 10 megavolts at a peak power of 10 megawatts and be tunable from 50 to 60 megahertz. Furthermore, tuning must be rapid; that is, the bandpass of the tuning circuit must be on the order of 30 kilohertz. The ferrite-tuned rf systems used in the past are typically capable of providing only 5 to 10 kilovolts per gap at up to 50 kilowatts and, in addition, are limited by power dissipation in the ferrite tuners and plagued by strong, uncontrollable nonlinear effects. We have chosen to concentrate the modest development funds available at present on the rf system. A teststand is being built, and various ferrites are being studied to gain a better understanding of their behavior.

Following a lead from the microwave industry (one recently applied in a buncher cavity developed by the Laboratory's Accelerator Technology Division for the Proton Storage Ring), we have chosen a bias magnetic field perpendicular to the rf magnetic field. (All other proton accelerators employ parallel bias.) The advantage of perpendicular bias is a reduction in the ferrite losses by as much as

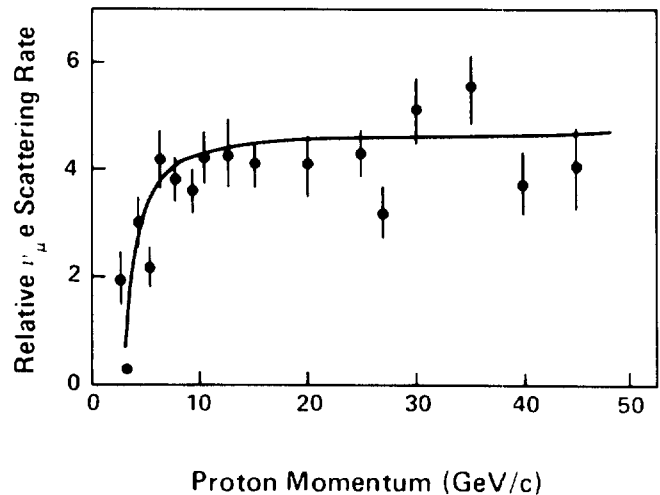

Fig. 5. Monte-Carlo calculation of the rate of scattering between muon neutrinos and electrons (in an unbiased 4-meter by 4-meter detector located 90 meters from a beryllium neutrino-production target) as a function of the momentum of the protons producing the neutrinos. (The solid curve is simply a guide to the eye.) The calculations are based on various experimental values of the pion-production rate. The scattering rate plotted is the rate per unit power in the proton beam. The momentum of the protons to be produced by the LAMPF II booster (9.9 GeV/c) is well above the knee of the yield curve.

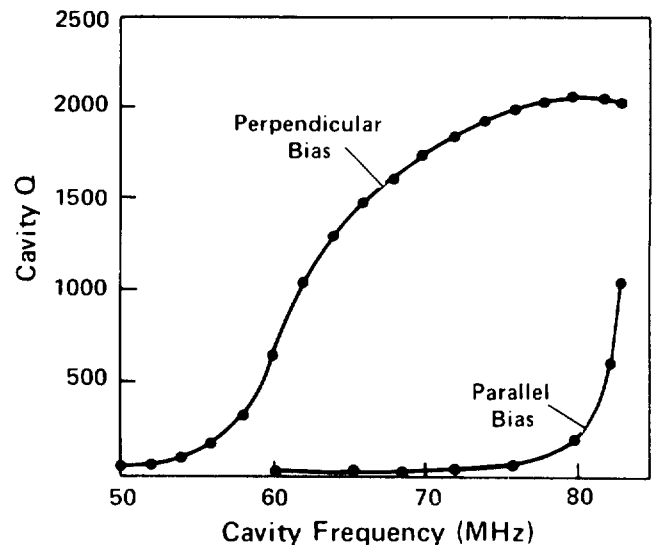

Fig. 6. Performance of ferrite-tuned test cavities with parallel and perpendicular bias magnetic fields. The data shown are for a Ni-Zn ferrite; other types of ferrites give similar results.

two orders of magnitude (Fig. 6). Since the loss in the ferrite is proportional to the square of the voltage on each gap, reducing these losses is essential to achieving the performance required of the LAMPF II system.

A collaboration led by R. Carlini and including the Medium Energy and Accelerator Technology divisions and the University of Colorado has made a number of tests of the perpendicular bias idea. Their results indicate that in certain ferrites the low losses persist at power levels greater than that needed for the LAMPF II cavities. A full-scale cavity is now being constructed to demonstrate that 100 kilovolts per gap at 300 kilowatts is possible. This prototype will also

help us make a choice of ferrite based on both rf performance and cost of the bias system. A full-scale, full-power prototype of the rf system is less than a year away.

Conclusion

This presentation of interesting experiments that could be carried out at LAMPF II is of necessity incomplete. In fact, the range of possibilities offered by LAMPF II is greater than that offered by any other facility being considered by the nuclear science community. Its funding would yield an extraordinary return. ■

References

1. J. J. Aubert et al. (The European Muon Collaboration). "The Ratio of the Nucleon Structure Functions F_2^p for Iron and Deuterium." *Physics Letters* 123B(1983):275.
2. A. Bodek et al. "Electron Scattering from Nuclear Targets and Quark Distributions in Nuclei." *Physical Review Letters* 50(1983):1431.
3. A. Bodek et al. "Comparison of the Deep-Inelastic Structure Functions of Deuterium and Aluminum Nuclei." *Physical Review Letters* 51(1983):534.
4. R. G. Arnold et al. "Measurements of the A Dependence of Deep-Inelastic Electron Scattering from Nuclei." *Physical Review Letters* 52(1984):727.
5. T. A. Carey, K. W. Jones, J. B. McClelland, J. M. Moss, L. B. Rees, N. Tanaka, and A. D. Bacher. "Inclusive Scattering of 500-MeV Protons and Pionic Enhancement of the Nuclear Sea-Quark Distribution." *Physical Review Letters* 53(1984):144.
6. I. R. Kenyon. "The Drell-Yan Process." *Reports on Progress in Physics* 45(1982):1261.
7. D. Strottman and W. R. Gibbs. "High Nuclear Temperatures by Antimatter-Matter Annihilation." Accepted for publication in *Physics Letters*.
8. W. Brückner et al. "Spin-Orbit Interaction of Lambda Particles in Nuclei." *Physics Letters* 79B(1978):157.
9. R. Bertini et al. "A Full Set of Nuclear Shell Orbitals for the Λ Particle Observed in ${}_{\Lambda}^{32}\text{S}$ and ${}_{\Lambda}^{40}\text{Ca}$."
10. A. Bouyssy. "Strangeness Exchange Reactions and Hypernuclear Spectroscopy." *Physics Letters* 84B(1979):41.
11. M. May et al. "Observation of Levels in ${}_{\Lambda}^{13}\text{C}$, ${}_{\Lambda}^{14}\text{N}$, and ${}_{\Lambda}^{18}\text{O}$ Hypernuclei." *Physical Review Letters* 47(1981):1106.
12. A review of these experiments was presented by G. Bunce at the Conference on the Intersections between Particle and Nuclear Physics, Steamboat Springs, Colorado, May 23-30, 1984, and will be published in the conference proceedings.

The SSC— An Engineering Challenge

by Mahlon T. Wilson

The accelerator known as the SSC (Superconducting Super Collider) is a bold idea that will enable a giant step forward in high-energy physics. Within a circular ring fifty to one hundred miles around, two proton beams will collide and liberate enough energy to create new particles up to fifty times heavier than the weak bosons. These energies are necessary to go beyond the plateau of understanding summarized by the standard model. Specific issues to be addressed include the mechanism for breaking the symmetry between electromagnetic and weak interactions, the possibility that quarks and leptons are composite particles, and the existence of quark-lepton families heavier than those now known. In addition, exploration of this higher energy region is quite likely to uncover entirely new phenomena.

To bring some order to the multitude of suggestions put forth for what should be attempted with this machine and how it should be built, the high-energy physics community has held a series of workshops both here and abroad. The workshops resulted in a decision to study in detail the technical feasibility and estimated cost of achieving one particular set of beam parameters. Over 150 representatives from a number of national laboratories and universities and a few commercial firms contributed to this Reference Designs Study, which was headquartered at Lawrence Berkeley National

Laboratory and directed by Maury Tigner of Cornell University. This heroic effort occupied the first four months of this year and produced many thousands of pages of text and cost estimates. From these has been extracted a summary document of about two thousand pages, which will serve as a point of reference for continued discussion and development of a proposal to the Department of Energy for funding.

The objective addressed in the Reference Designs Study was provision of two 20-TeV proton beams capable of being collided head-on at up to six locations. The maximum luminosity of each beam was set at 10^{33} per square centimeter per second. Three design concepts for the magnetic field were considered, all incorporating superconducting magnets of niobium-titanium cooled by liquid helium to 4.5 kelvins. The accompanying table lists some features of the three designs worthy of the adjective "super." Much care was taken to include in the reference designs components whose performance and cost were based on those of existing equipment. When this was not possible, advocates of a proposed component were required to break the component down into items of known cost and to defend their estimate of total cost. A disagreement of even a few dollars in the estimated cost of any one item can be significant, since thousands of each of hundreds of items are needed for the accelerator. The similarity of the estimated

total costs for the three reference designs reflects a similarity between the greater costs associated with higher magnetic fields (more superconducting material) and those associated with physically larger accelerators (more cryogenic equipment, more excavation, more piping and cables, and so on).

The Reference Designs Study brought to light several engineering challenges that can be characterized as interesting, to say the least. A good first question is how to lay out an 18- to 33-mile-diameter circle with the required dimensional accuracy. The sheer size of the facilities being considered—the circumferences of which range from the highway distance between Los Alamos and Cochiti Pueblo to that between Los Alamos and Albuquerque—create unusual problems in communications.

The long magnets present challenges in fabrication, transportation, field testing, and alignment. For example, the 3-tesla magnets, which are about one and one-half football fields long but only a bit over one foot in diameter, will behave like wet noodles if improperly lifted. And although such long magnets can be bent sufficiently to conform to the topography of specially tailored roads, they must be supported during transport at intervals of about every ten feet. All the magnet versions raise other issues. The numerous plumbing and wiring connections must be of the highest quality. Several inches

Features of the three SSC designs considered in the Reference Designs Study. The 6.5-tesla design involves a conductor-dominated field with both beam tubes in a common cold-iron yoke that contributes slightly to shaping the field. In this design the dipole magnet, beam tubes, and yoke are supported within a single cryostat. The 5-tesla design involves a conductor-dominated dipole field with a heavy-walled iron cryostat to attenuate the fringe field. This single-bore design requires two separate rings of dipole magnets. The 3-tesla design is similar to the 6.5 tesla design except that the field is shaped predominantly by the cold-iron yoke rather than by the conductor.

Dipole Field (T)	Dipole Magnet Length (ft)	Accelerator Diameter (mi)	Total Estimated Cost (\$)
6.5	57	18	2.72 billion
5	46	23	3.05 billion
3	460	33	2.70 billion

of thermal contraction of the components within the cryostats must be accommodated. Heat leaks from power and instrumentation leads must be minimized, as must those from the magnet supports. (What is needed are supports with the strength of an ox yoke but the substance of a spider web.) Alignment will require some means for knowing the exact location of the magnets within their cryostats. And if a leak should develop in any of the piping within a magnet's cryostat, there needs to be a method for locating the "sick" magnet and determining where within it the problem exists.

Questions of safety, also, must be addressed. For example, the refrigerator locations every 2 to 5 miles around the ring are logical sites for personnel access, but is this often enough? What happens if a helium line should rupture? After all, a person can run only a few feet breathing helium. Will it be

necessary to exclude personnel from the tunnel when the system is cold, or can this problem be solved with, say, supplied-air suits or vehicles?

Achieving head-on collisions of the beams presents further challenges. Each beam must be focused down to 10 microns and, more taxing, be positioned to within an accuracy of about 1 micron. It takes a reasonably good microscope even to see something that small! Will a truck rumbling by shake the beams out of a collision course? What will be the effect of earth tides or earthquakes? Does the ground heave due to annual changes in temperature or water-table level? How stable is the ground in the first place? That is, does part of the accelerator move relative to the remainder? Will it be desirable, or necessary, to have a robot system constantly moving around the ring tweaking the positions of the magnets? What would the robot, or any

surveyor, use as a reference for alignment?

These are but a few of the many issues that have been raised about construction and operation of the SSC. Resolving them will require considerable technology and ingenuity.

In April of this year, the Department of Energy assigned authority over the SSC effort to Universities Research Association (URA), the consortium of fifty-four universities that runs Fermilab. URA, in turn, assigned management responsibilities to a separate board of overseers under Boyce McDaniel of Cornell University. This board selected Maury Tigner as director and Stanley Wojcicki of Stanford University as deputy director for SSC research and development. A headquarters is being established at Lawrence Berkeley National Laboratory, and a team will be drawn together to define what the SSC must do and how best that can be done. Secretary of Energy Donald Hodel has approved the release of funds to support the first year of research and development. Since the \$20 million provided was about half the amount felt necessary for progress at the desired rate, shortcuts must be taken in reaching a decision on magnet type so that site selection can begin soon.

Los Alamos has been involved in the efforts on the SSC since the beginning. We have participated in numerous workshops, collated siting information and published a Site Atlas, and contributed to the portions of the Reference Designs Study on beam dynamics and the injector. We may be called upon to provide the injector linac, kicker magnets, accelerating cavities, and numerous other accelerator components. Our research on magnetic refrigeration has the potential of halving the operating cost of the cryogenic system for the SSC. Although the results of this research may be too late to be incorporated in the initial design, magnetic refrigerator replacements for conventional units would quickly repay the investment. ■